



PROFESSIONAL













RETTUNGSDATENBLÄTTER



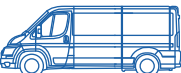

INHALTSVERZEICHNIS

PROFESSIONAL

FIAT DOBLÒ		→12/2009	1		
FIAT DOBLÒ		NATURAL POWER	→12/2009	2	
FIAT DOBLÒ		NATURAL POWER	→12/2009	3	
FIAT DOBLÒ		01/2010	→	4	
FIAT DOBLÒ		01/2010	→	5	
FIAT DOBLÒ		NATURAL POWER	01/2010	→	6
FIAT DOBLÒ		NATURAL POWER	01/2010	→	7
FIAT DOBLÒ		NATURAL POWER	01/2010	→	8
FIAT DUCATO			9		
FIAT DUCATO			10		
FIAT DUCATO			11		
FIAT DUCATO		NATURAL POWER	12		
FIAT FIORINO		01/2008	→	13	
FIAT FIORINO		NATURAL POWER	01/2008	→	14
FIAT SCUDO			15		
FIAT STRADA			16		



FIAT DOBLO'(223) (BIS_12/2009)



PROFESSIONAL

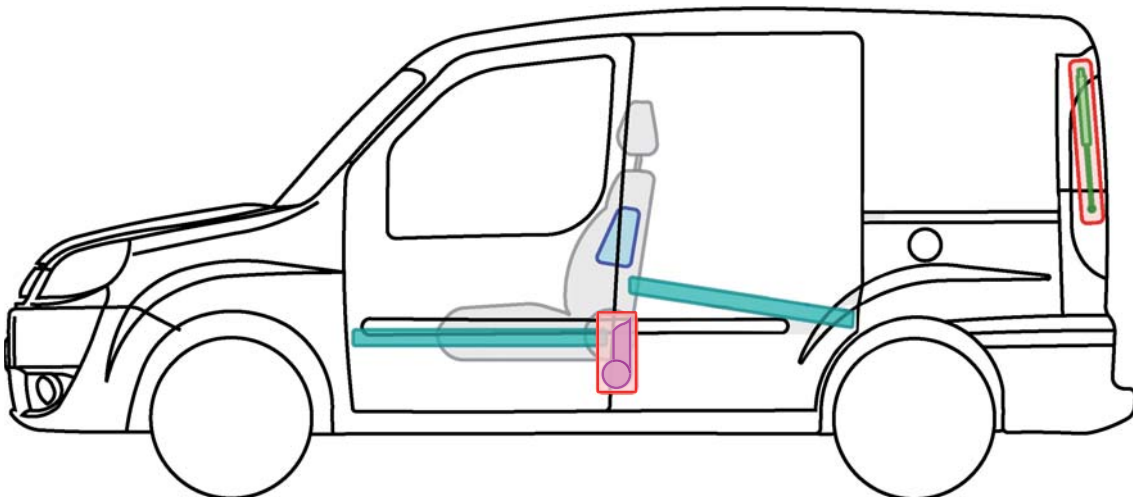
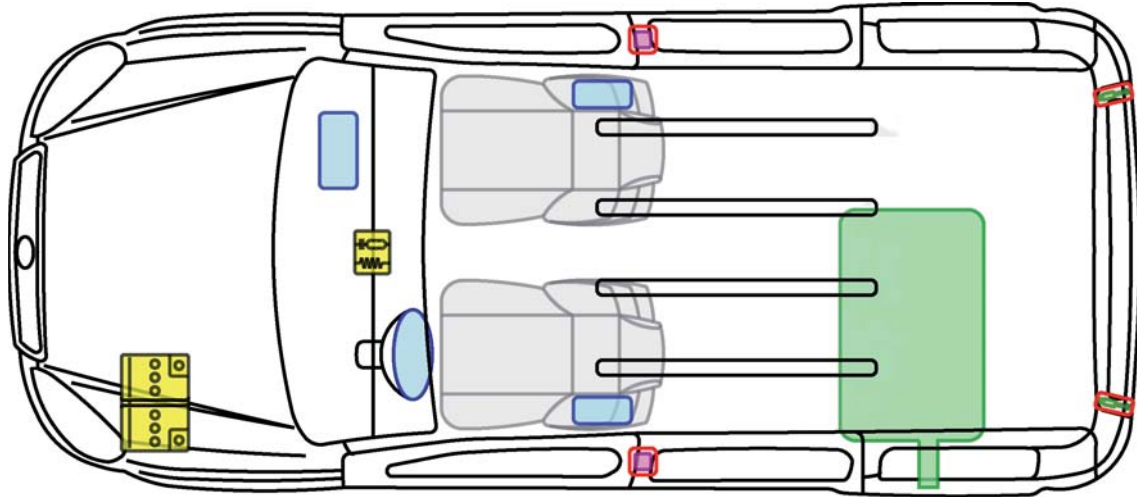

Legende



Airbag



Karosserie-
verstärkung



Airbag
Steuergerät



Gas-
generator



Batterie



Gurt-
straffer

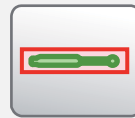

Gasdruck-
dämpfer



Kraftstoff-
tank



FIAT DOBLO'(223) (BIS_12/2009)



PROFESSIONAL

NATURAL POWER

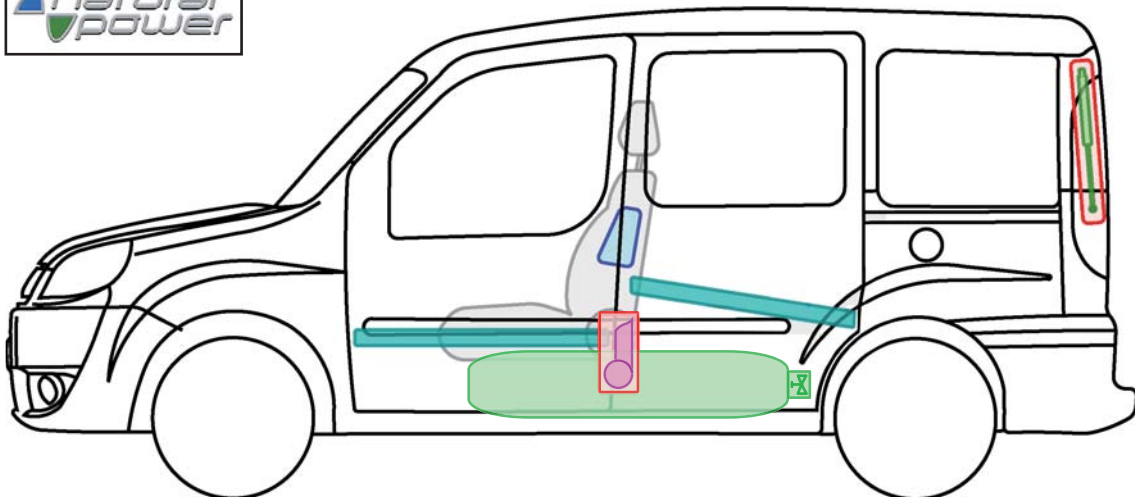
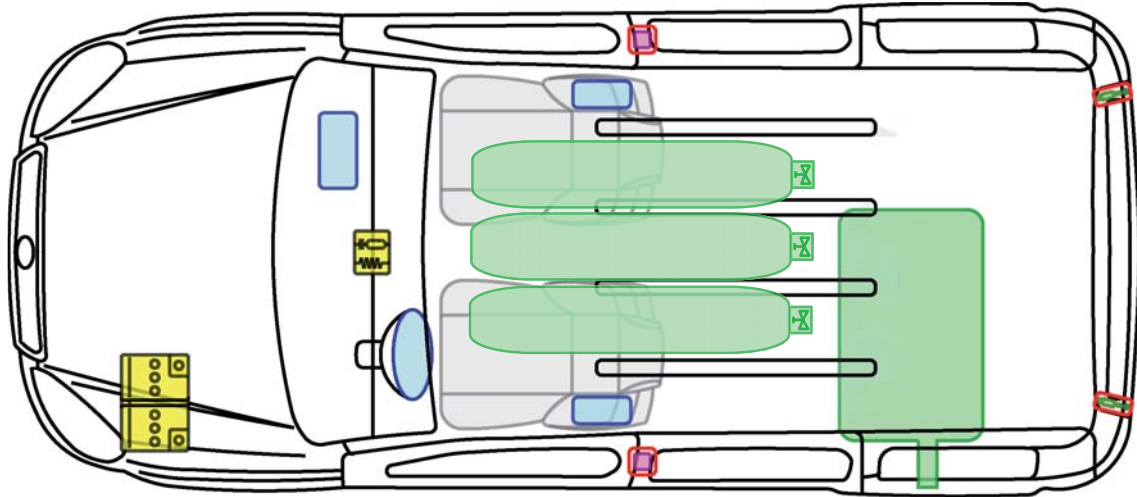

Legende



Airbag



Karosserie-
verstärkung



Airbag
Steuergerät

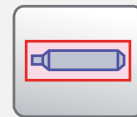

Gas-
generator



Batterie



Gurt-
strafer

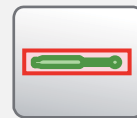

Gasdruck-
dämpfer



Kraftstoff-
tank



Gastank



Sicherheits-
ventil



FIAT DOBLO'(223) (BIS_12/2009)



PROFESSIONAL

NATURAL POWER

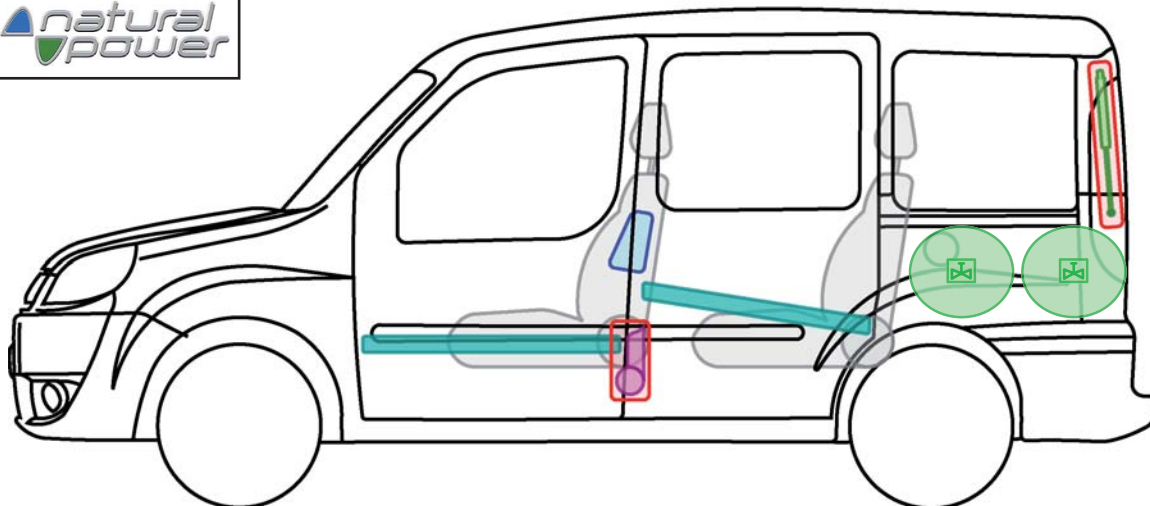
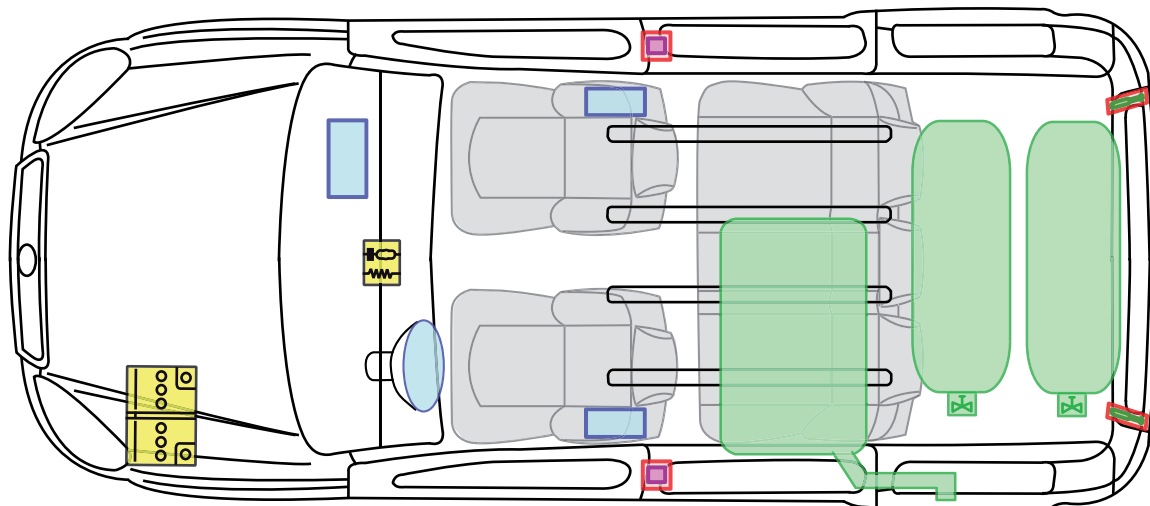

Legende



Airbag



Karosserie-
verstärkung



Airbag
Steuergerät



Gas-
generator



Batterie



Gurt-
straffer

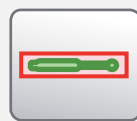

Gasdruck-
dämpfer



Kraftstoff-
tank



Gastank



Sicherheits-
ventil



FIAT DOBLO'



(AB_01/2010)



PROFESSIONAL

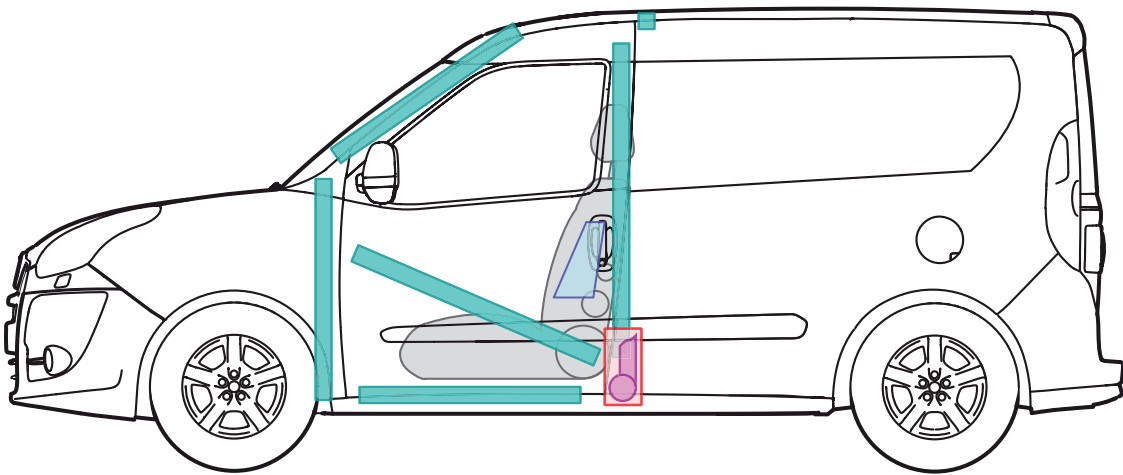
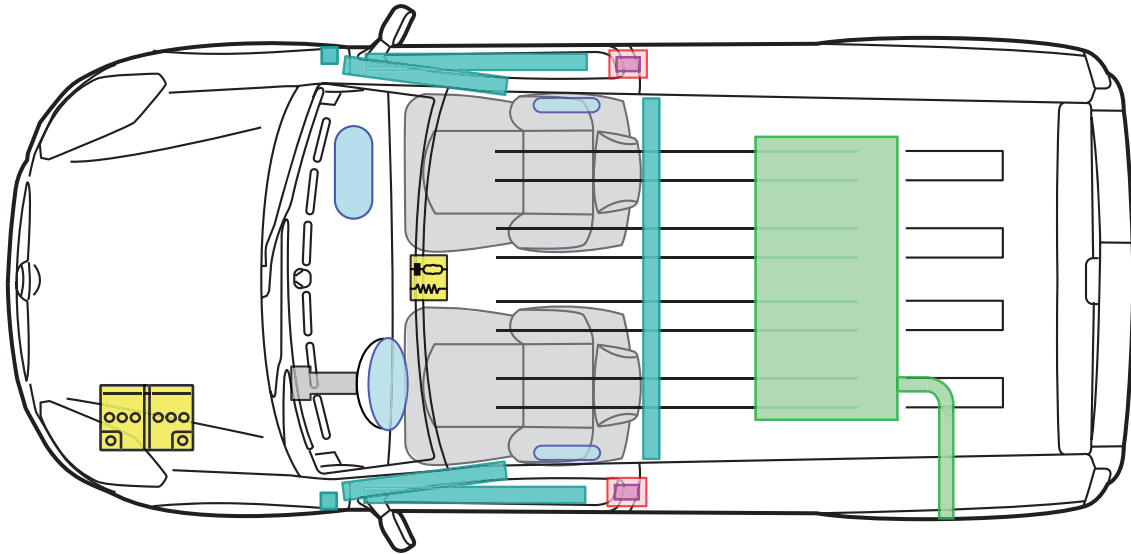

Legende



Airbag



Karosserie-
verstärkung



Airbag
Steuergerät

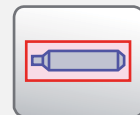

Gas-
generator

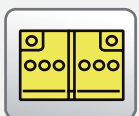

Batterie



Gurt-
straffer

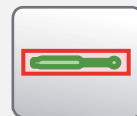

Gasdruck-
dämpfer



Kraftstoff-
tank



FIAT DOBLO'



(AB_01/2010)



PROFESSIONAL

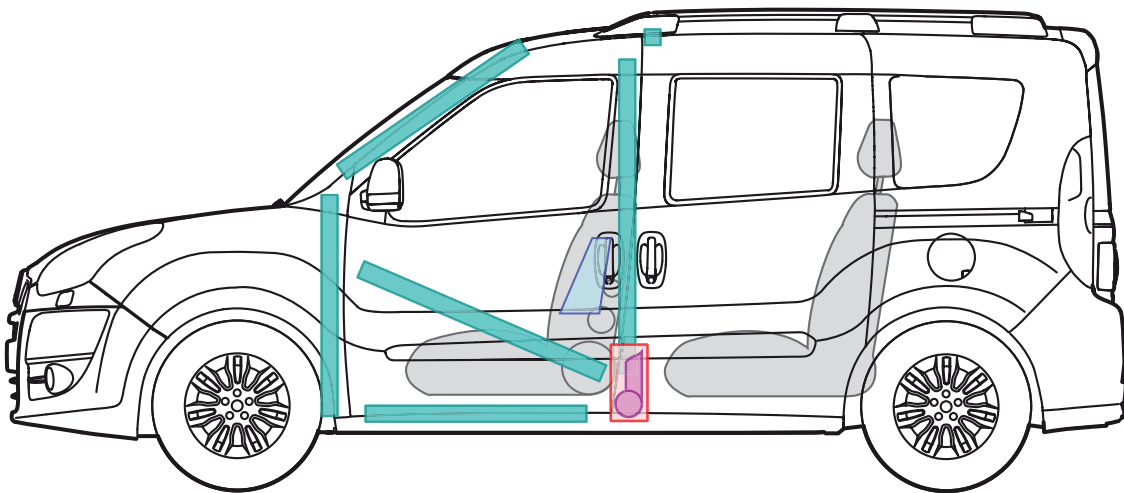
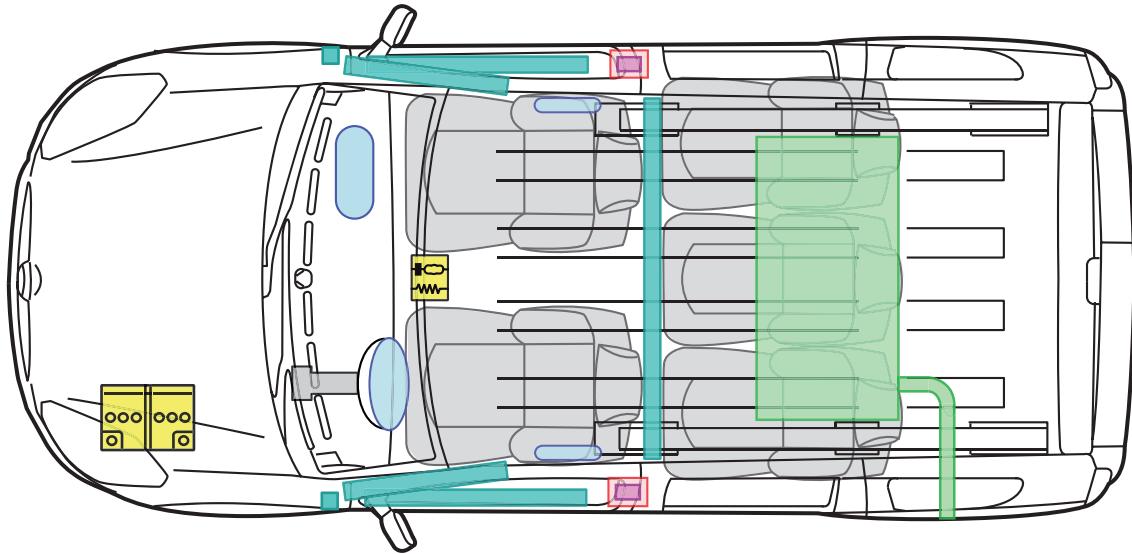

Legende



Airbag



Karosserie-
verstärkung



Airbag
Steuergerät

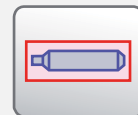

Gas-
generator

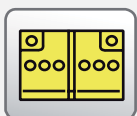

Batterie



Gurt-
straffer

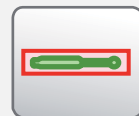

Gasdruck-
dämpfer



Kraftstoff-
tank



FIAT DOBLO'



(AB_01/2010)



PROFESSIONAL

NATURAL POWER

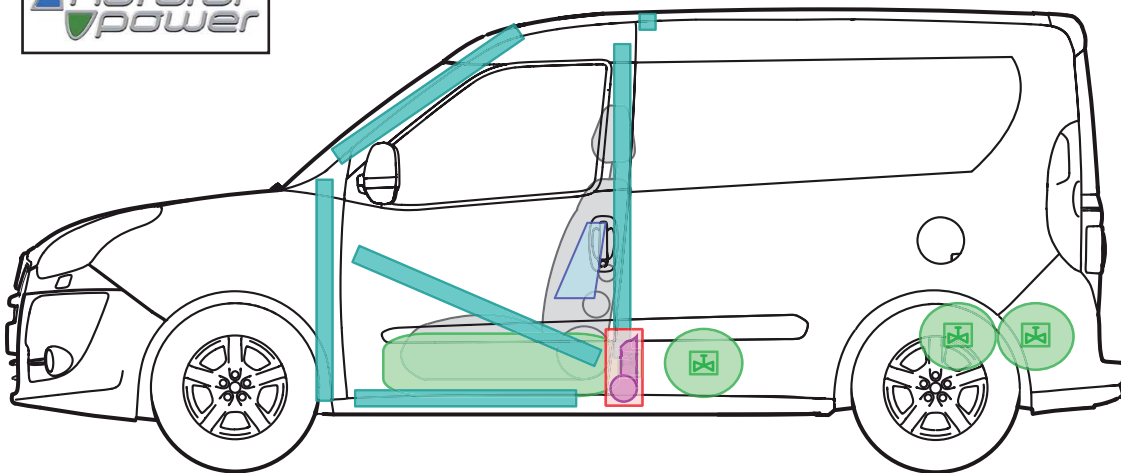
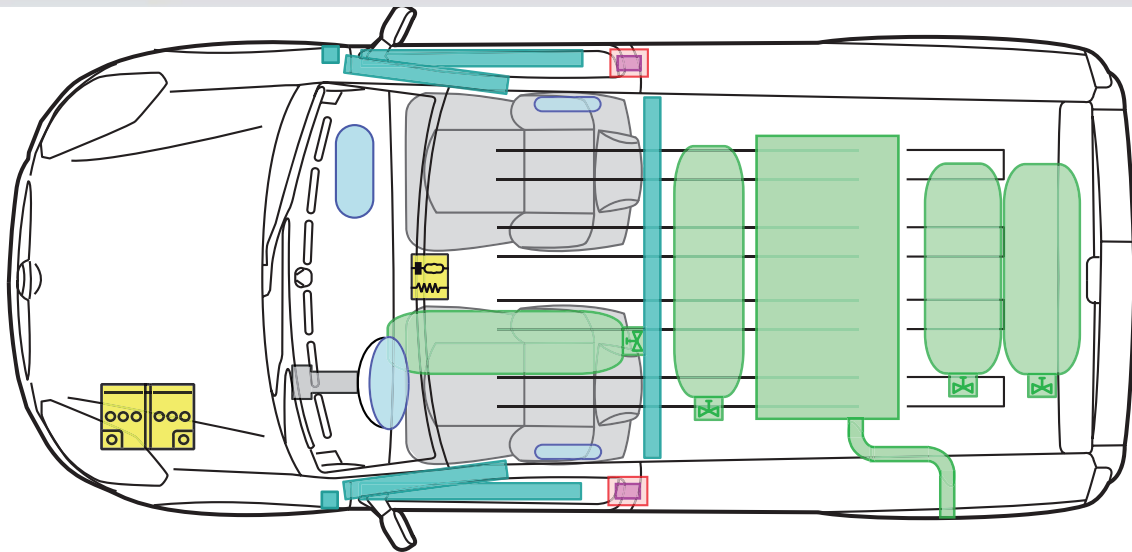

Legende



Airbag



Karosserie-
verstärkung



Airbag
Steuergerät



Gas-
generator



Batterie



Gurt-
straffer

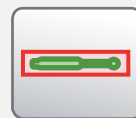

Gasdruck-
dämpfer



Kraftstoff-
tank



Gastank



Sicherheits-
ventil



FIAT DOBLO'



(AB_01/2010)



PROFESSIONAL

NATURAL POWER

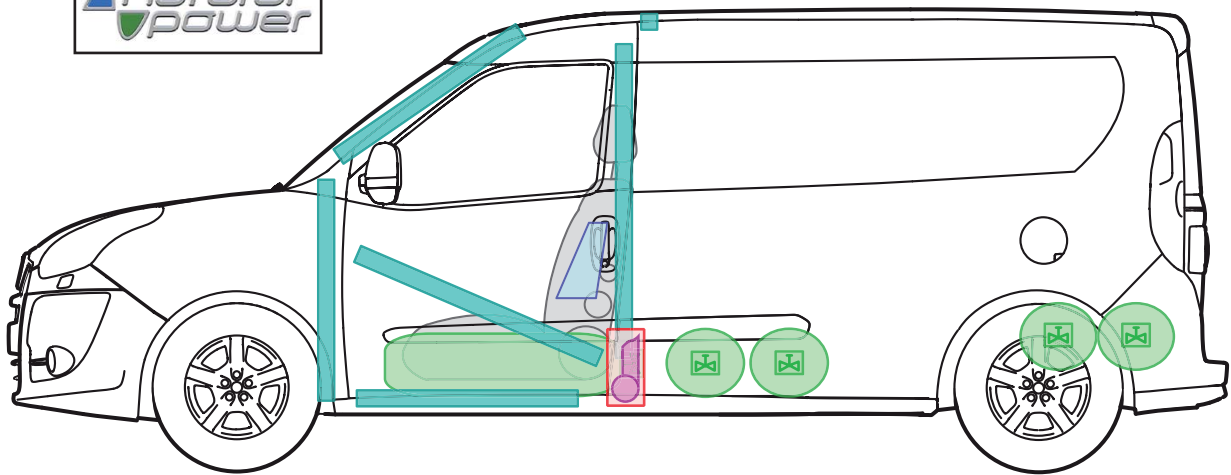
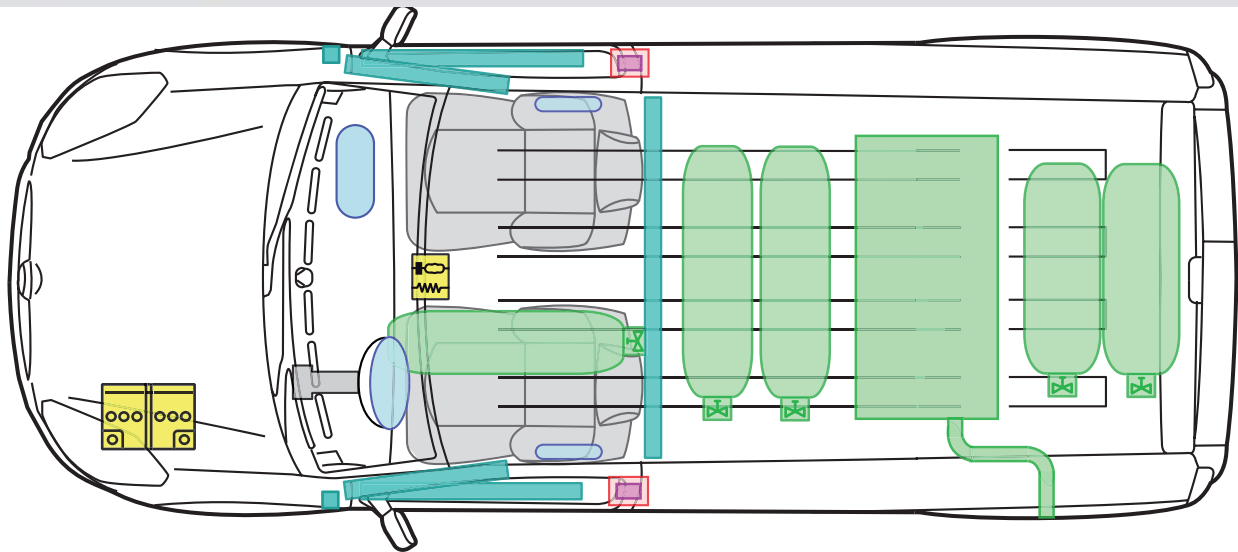

Legende



Airbag



Karosserie-
verstärkung



Airbag
Steuergerät

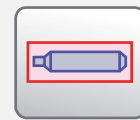

Gas-
generator



Batterie

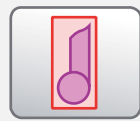

Gurt-
straffer

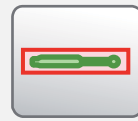

Gasdruck-
dämpfer



Kraftstoff-
tank



Gastank



Sicherheits-
ventil



FIAT DOBLO'



(AB_01/2010)



PROFESSIONAL

NATURAL POWER

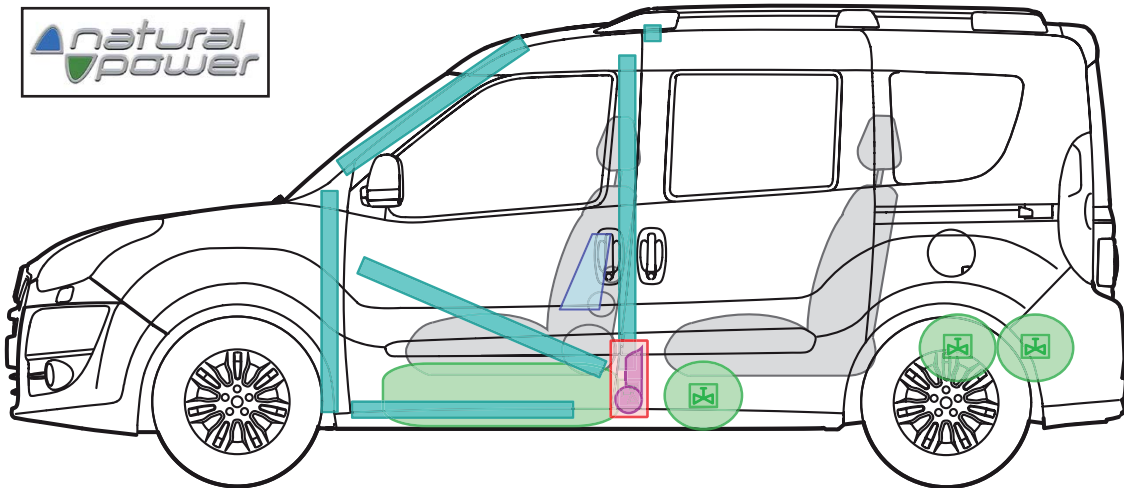
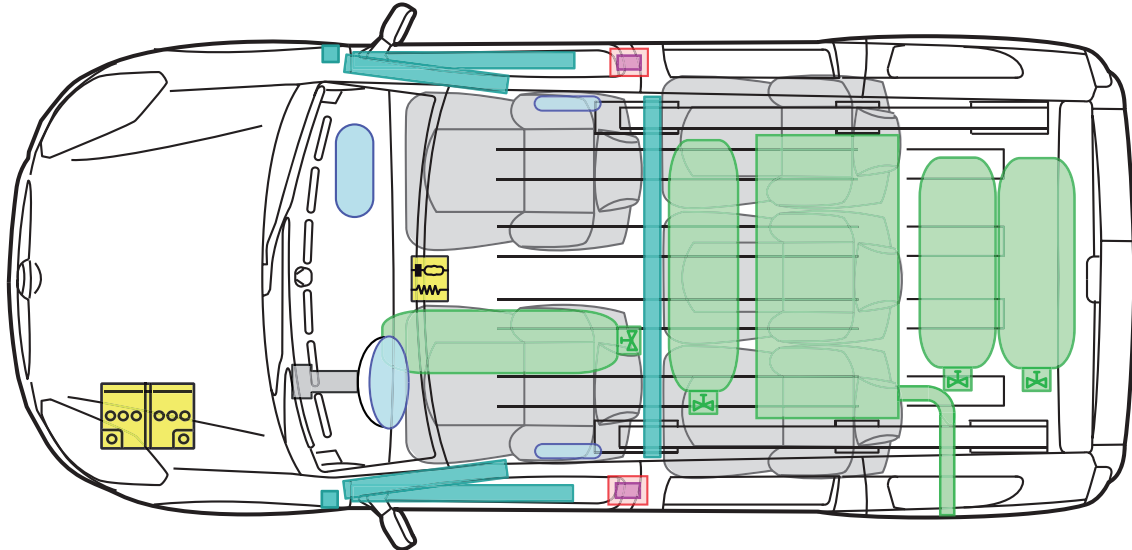

Legende



Airbag



Karosserie-
verstärkung



Airbag
Steuergerät

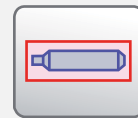

Gas-
generator

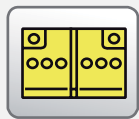

Batterie



Gurt-
straffer

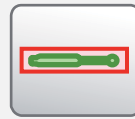

Gasdruck-
dämpfer



Kraftstoff-
tank



Gastank



Sicherheits-
ventil



FIAT DUCATO

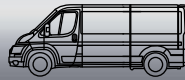

PROFESSIONAL

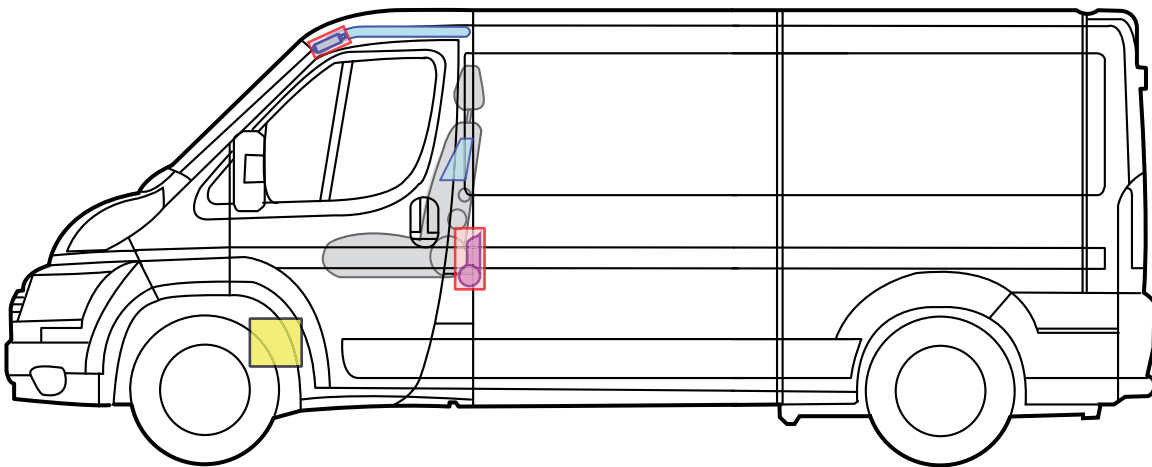
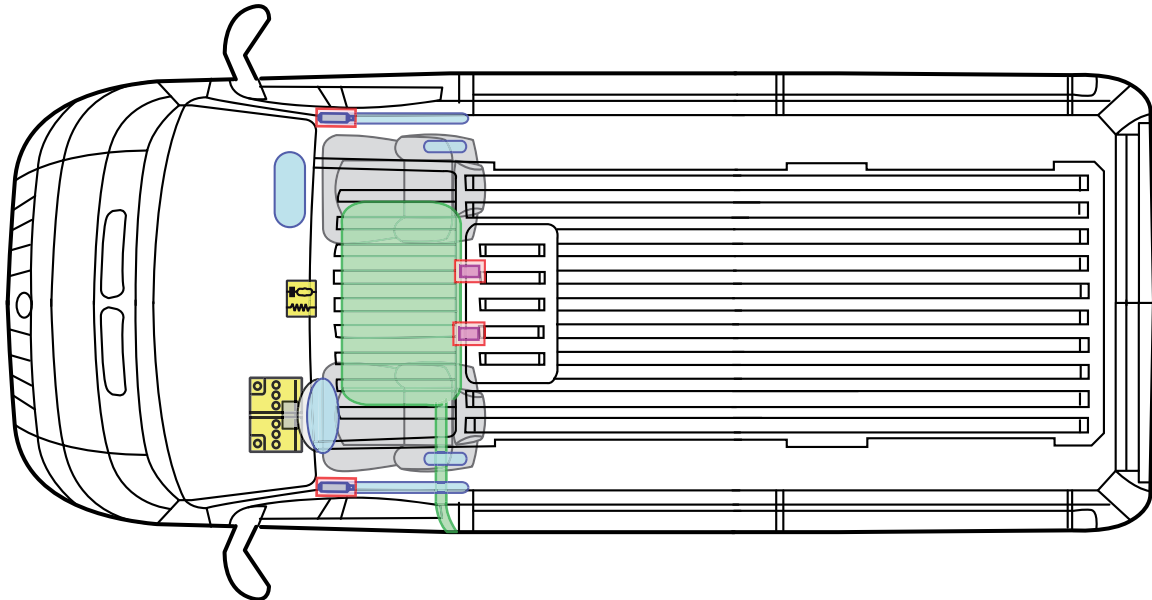

Legende



Airbag



Karosserie-
verstärkung

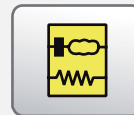

Airbag
Steuergerät



Gas-
generator

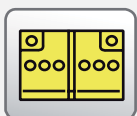

Batterie



Gurt-
straffer

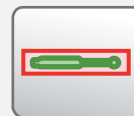

Gasdruck-
dämpfer



Kraftstoff-
tank



FIAT DUCATO



PROFESSIONAL

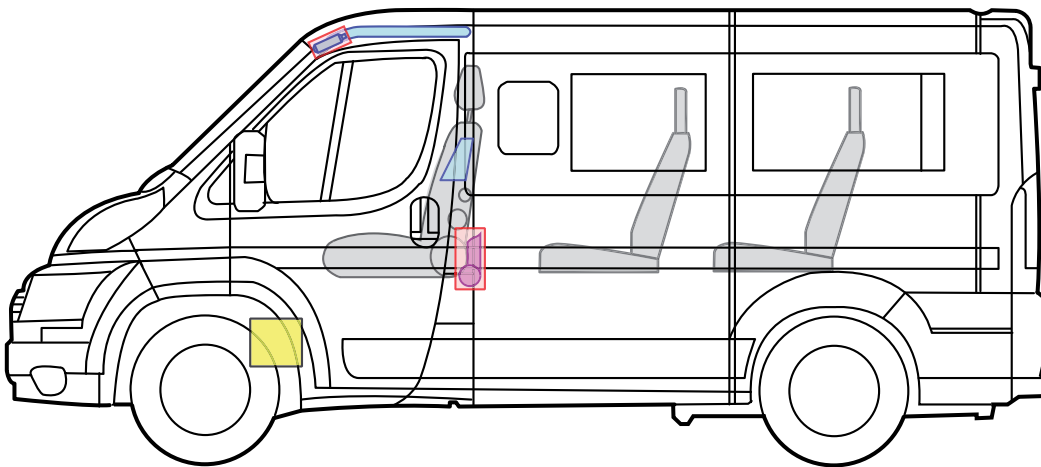
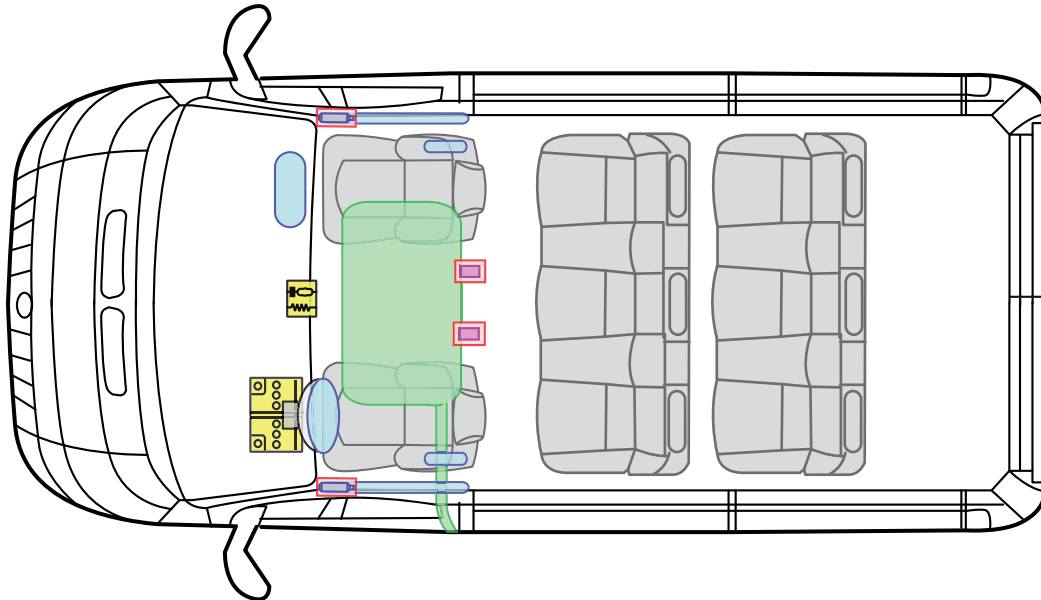

Legende



Airbag



Karosserie-
verstärkung



Airbag
Steuergerät



Gas-
generator

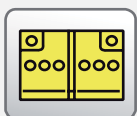

Batterie



Gurt-
straffer

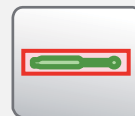

Gasdruck-
dämpfer



Kraftstoff-
tank



FIAT DUCATO

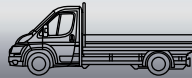

PROFESSIONAL

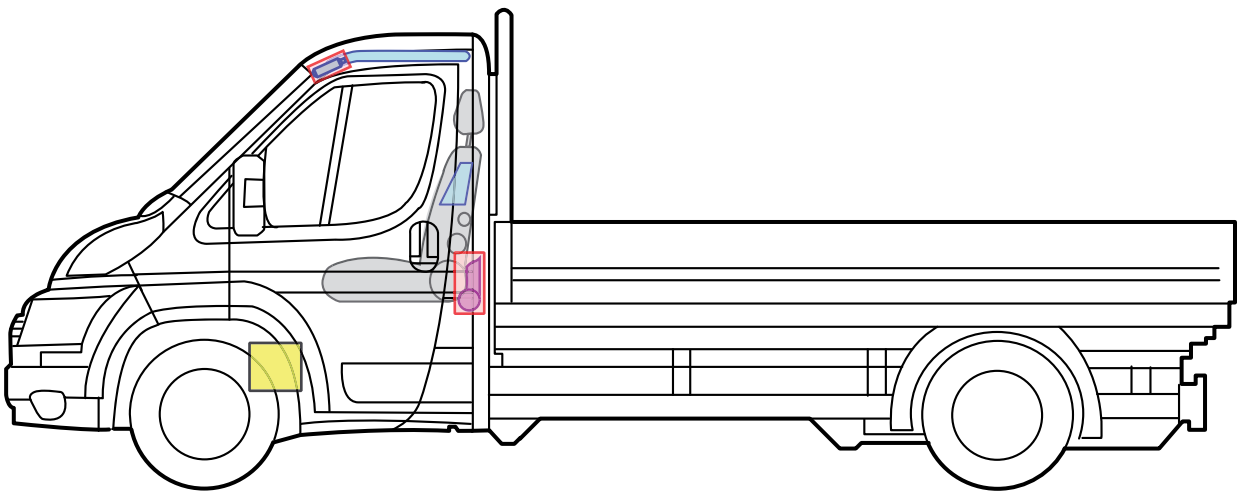
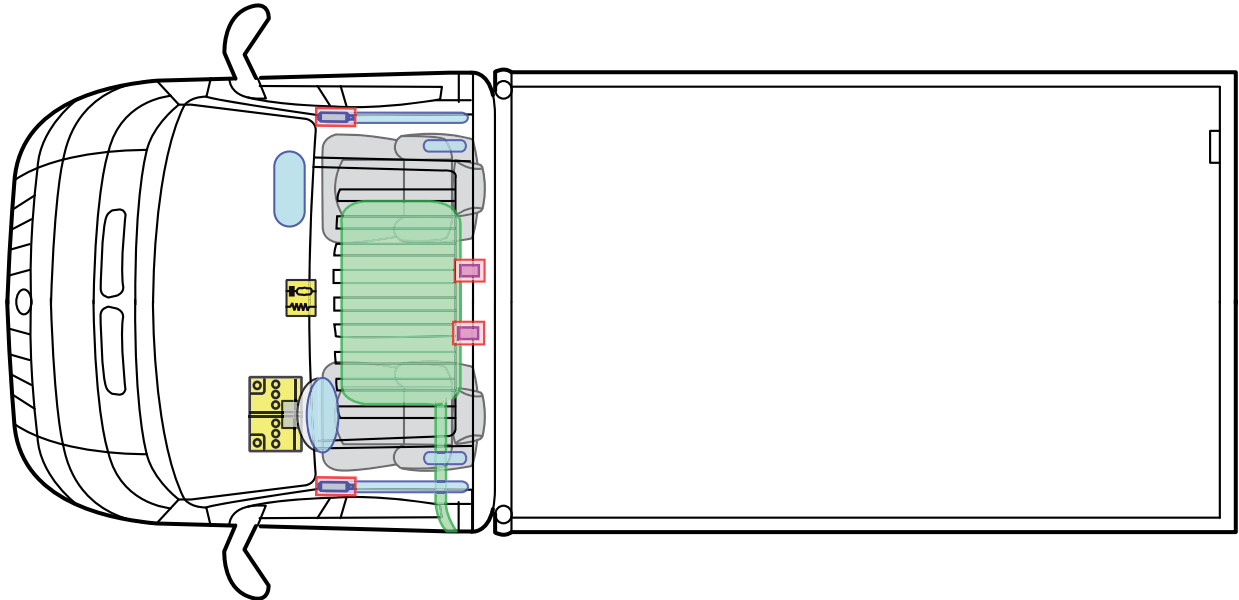

Legende



Airbag



Karosserie-
verstärkung



Airbag
Steuergerät

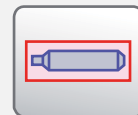

Gas-
generator

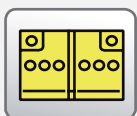

Batterie



Gurt-
straffer

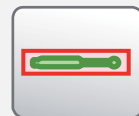

Gasdruck-
dämpfer



Kraftstoff-
tank



FIAT DUCATO NATURAL POWER



PROFESSIONAL

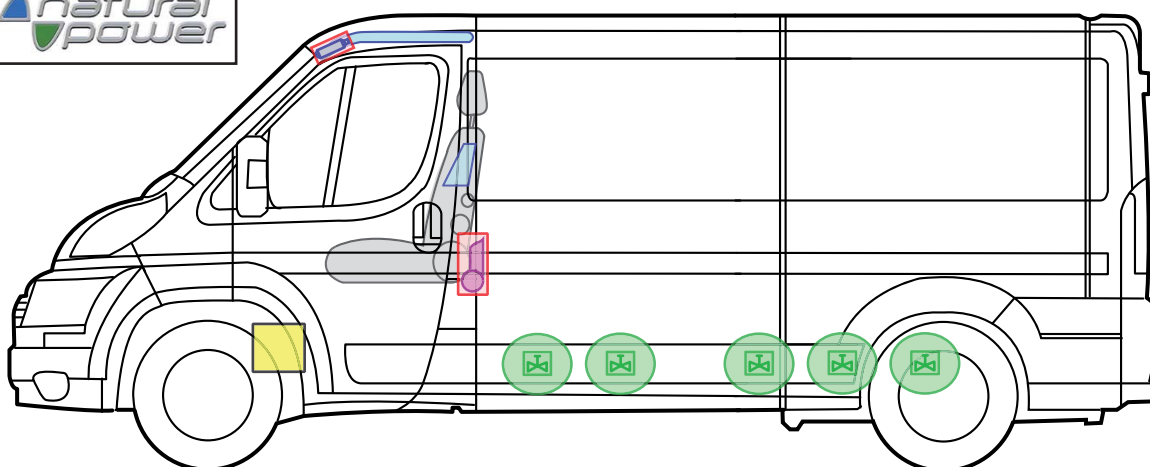
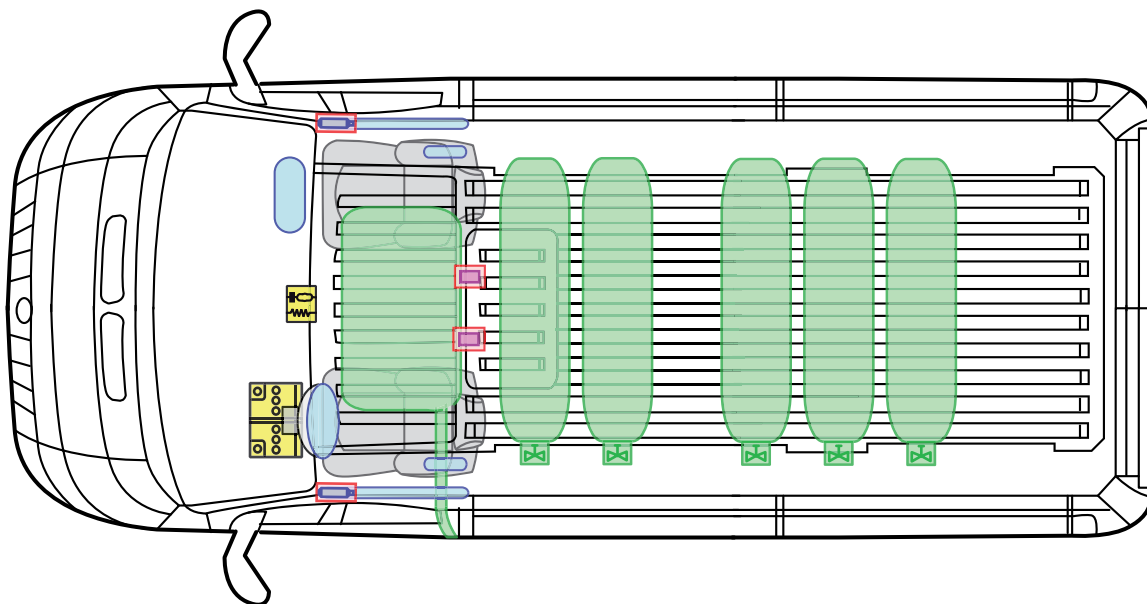

Legende



Airbag



Karosserie-
verstärkung



Airbag
Steuergerät



Gas-
generator

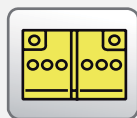

Batterie



Gurt-
straffer



Gasdruck-
dämpfer



Kraftstoff-
tank



Gastank



Sicherheits-
ventil



FIAT FIORINO (AB_01/2008)



PROFESSIONAL

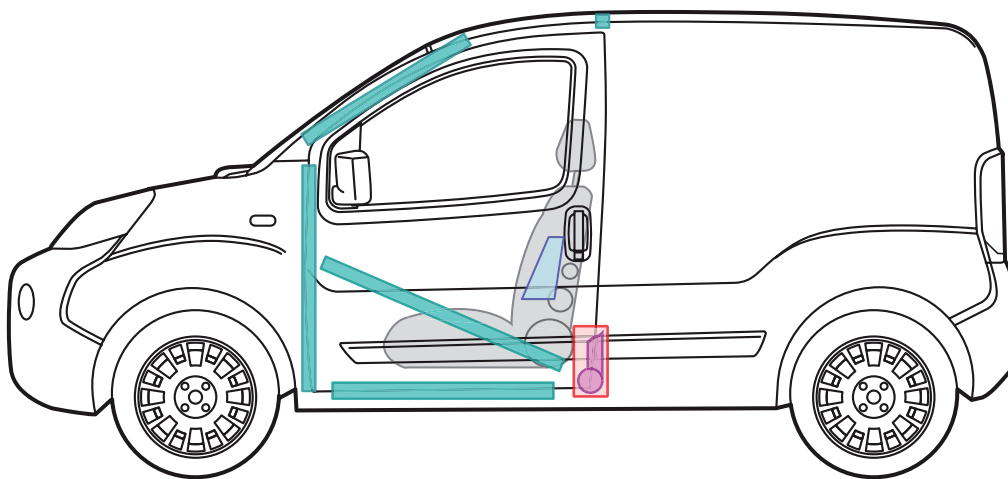
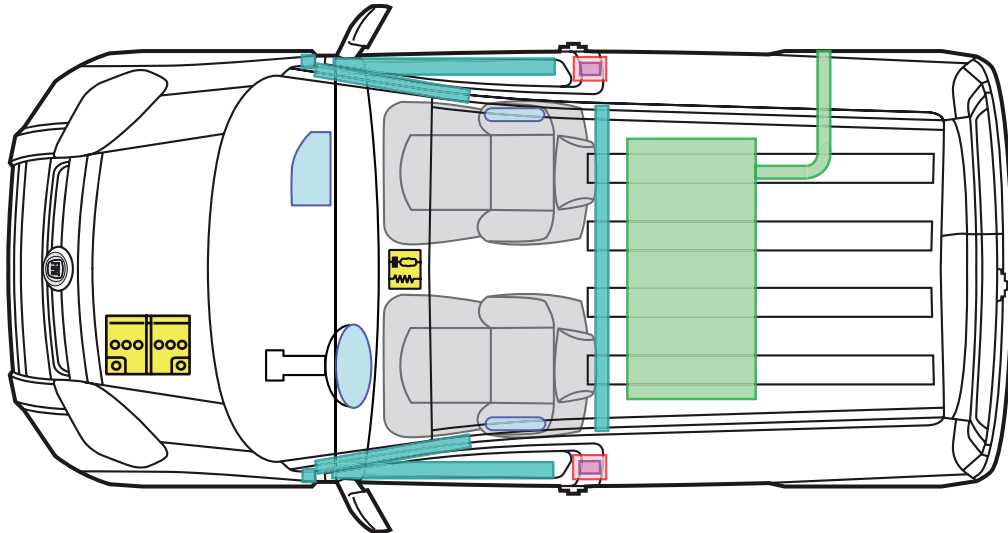

Legende



Airbag



Karosserie-
verstärkung



Airbag
Steuergerät

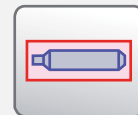

Gas-
generator

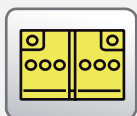

Batterie



Gurt-
straffer

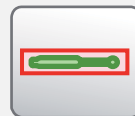

Gasdruck-
dämpfer



Kraftstoff-
tank



FIAT FIORINO (AB_01/2008)



PROFESSIONAL

NATURAL POWER

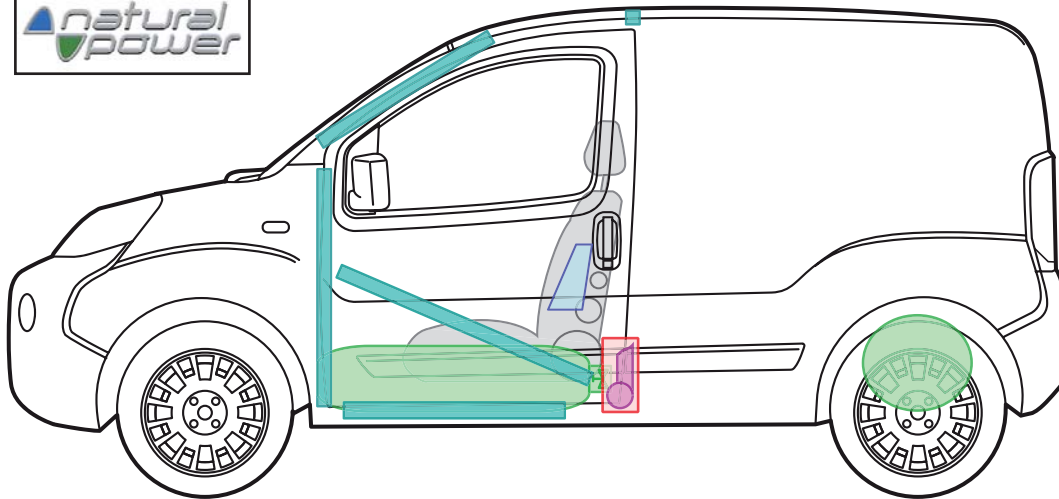
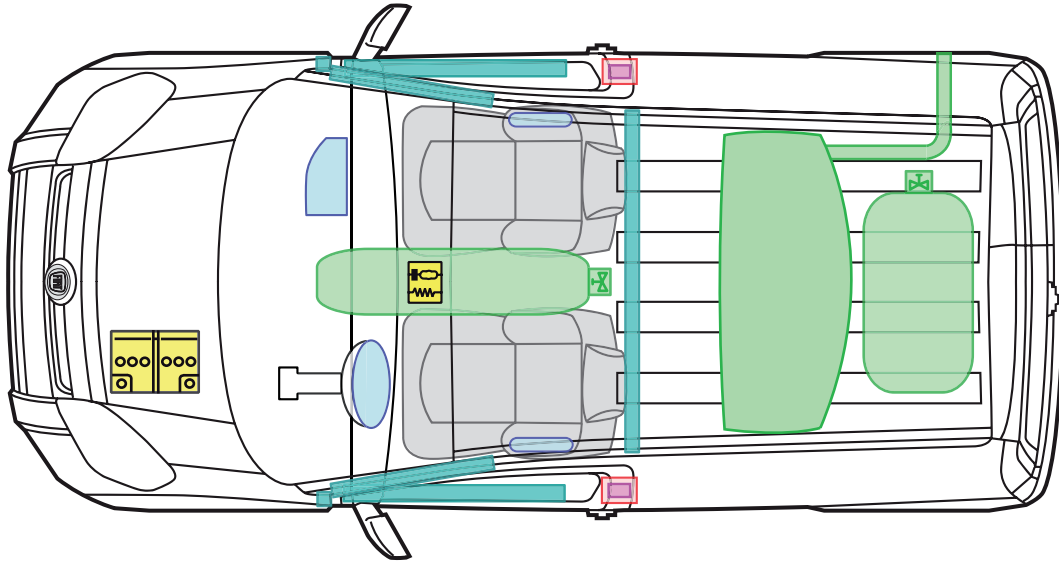

Legende

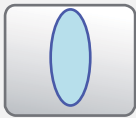

Airbag



Karosserie-
verstärkung

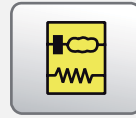

Airbag
Steuergerät

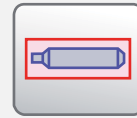

Gas-
generator

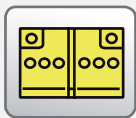

Batterie



Gurt-
strafer

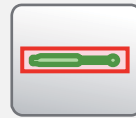

Gasdruck-
dämpfer



Kraftstoff-
tank



Gastank



Sicherheits-
ventil



FIAT SCUDO



PROFESSIONAL

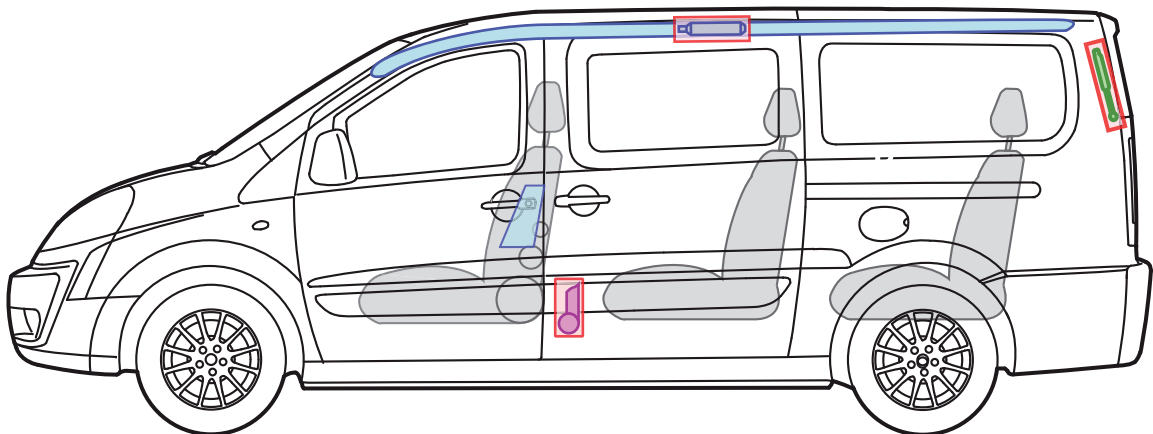
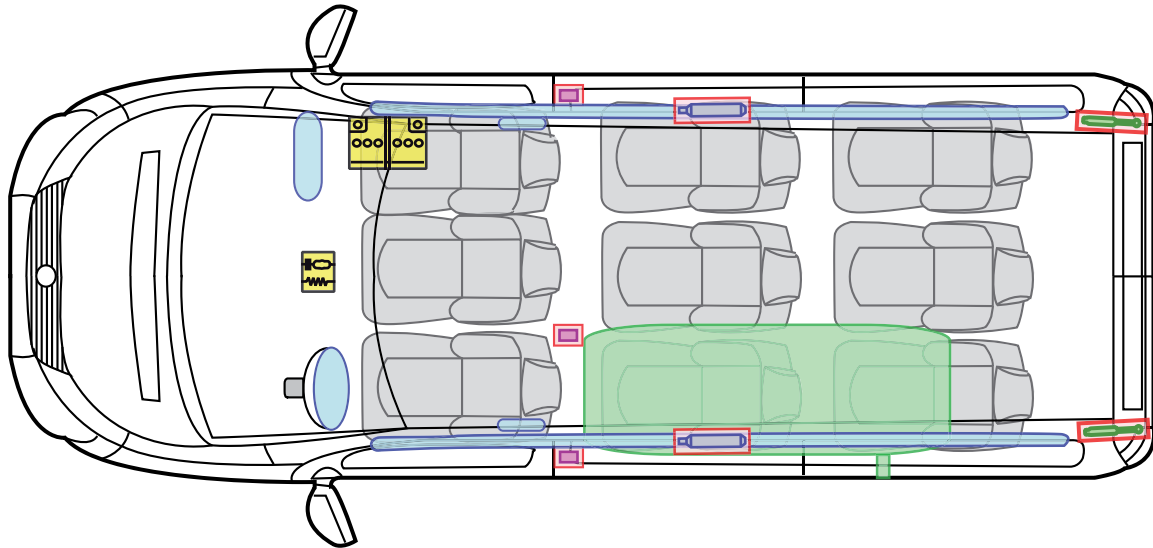

Legende



Airbag



Karosserie-
verstärkung



Airbag
Steuergerät

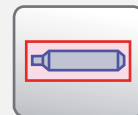

Gas-
generator

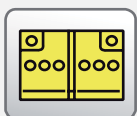

Batterie



Gurt-
straffer

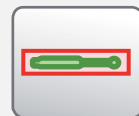

Gasdruck-
dämpfer



Kraftstoff-
tank



FIAT STRADA



PROFESSIONAL

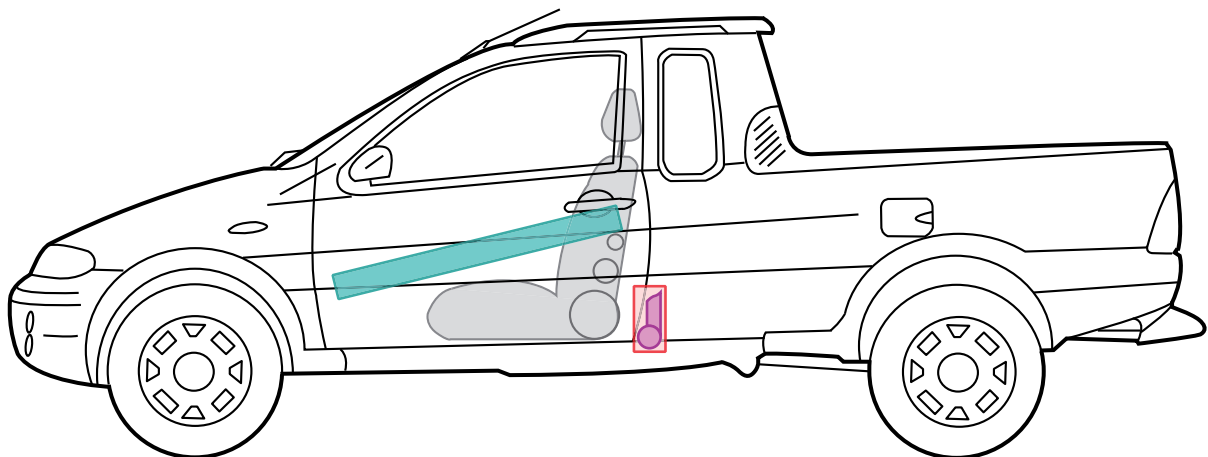
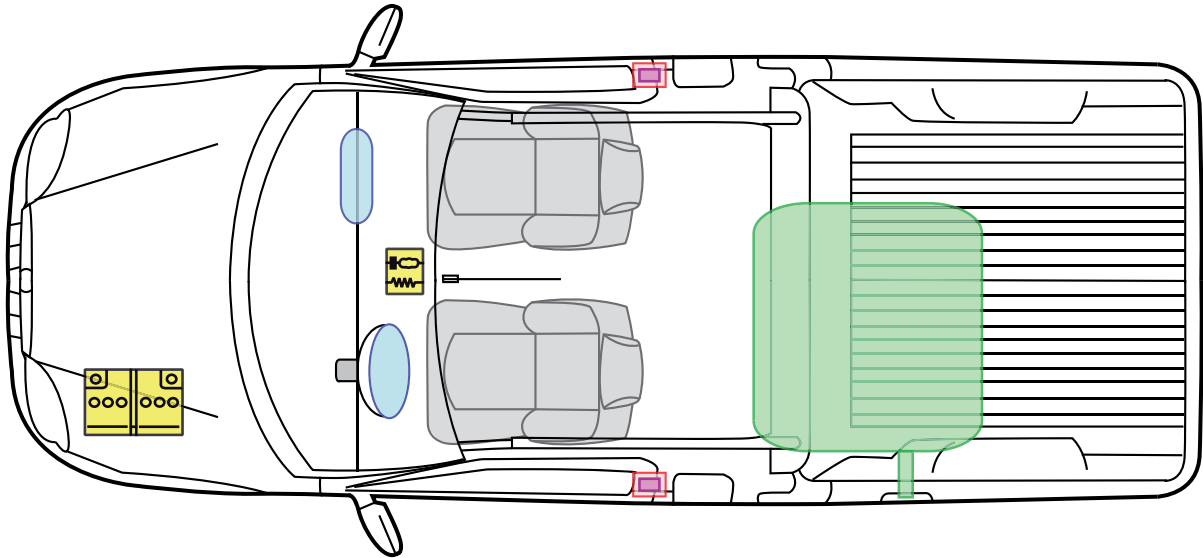

Legende



Airbag



Karosserie-
verstärkung



Airbag
Steuergerät

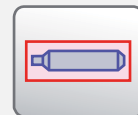

Gas-
generator

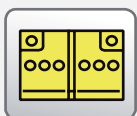

Batterie



Gurt-
straffer

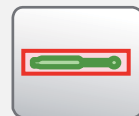

Gasdruck-
dämpfer



Kraftstoff-
tank