

F I A T B R A V O



O W N E R H A N D B O O K

## Dear Customer,

Thank you for selecting Fiat and congratulations on your choice of a Fiat Bravo.

We have written this handbook to help you get to know all your new Fiat Bravo features and use it in the best possible way.

You should read it right through before taking the road for the first time.

You will find information, tips and important warnings regarding the driving of your car to help you derive the maximum from your Fiat Bravo technological features.

You are recommended to read carefully the warnings and indications, marked with the respective symbols, at the end of the page:



personal safety;



the car's wellbeing;



environmental protection.

The enclosed Warranty Booklet lists the services that Fiat offers to its Customers:

- the Warranty Certificate with terms and conditions for maintaining its validity
- the range of additional services available to Fiat Customers.

Best regards and good motoring!

**This Owner Handbook describes all Fiat Bravo versions.  
As a consequence, you should consider only the information which is related to the engine  
and bodywork version of the car you purchased.**

# MUST BE READ!

## REFUELLING





**Petrol engines:** only refuel with unleaded petrol with octane rating (RON) not less than 95 conforming to the European specification EN 228.

**Diesel engines:** only refuel with diesel fuel conforming to the European specification EN590. Using other products or mixtures may damage the engine beyond repair and cause the forfeiture of the warranty cover for caused damages as a consequence.

## ENGINE STARTING



**Petrol engines:** make sure that the handbrake is engaged; set the gearshift lever to neutral; fully depress the clutch without pressing the accelerator, then turn the ignition key to AVV and release it as soon as the engine has started.

**Diesel engines:** turn the ignition key to MAR and wait for the warning lights  (or symbol on display) and  to go off; turn the ignition key to AVV and release it as soon as the engine has started.

## PARKING ON FLAMMABLE MATERIAL



While working, the catalyst develops a very high temperature. Do not park the car over grass, dry leaves, pine needles or any other inflammable materials: risk of fire.

## RESPECTING THE ENVIRONMENT



The car is fitted with a system that allows continuous diagnosis of the components correlated with emissions to ensure better respect for the environment.

## ELECTRICAL ACCESSORIES

If, after buying the car, you decide to add electrical accessories (that will gradually drain the battery), visit a Fiat Dealership. They can calculate the overall electrical requirement and check that the car's electric system can support the required load.

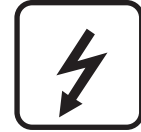

## CODE card

Keep the code card in a safe place, not in the car. The code card shall be used for requesting additional keys.

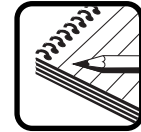



## SCHEDULED SERVICING

Correct maintenance of the car is essential for ensuring it stays in tip-top condition and safeguards its safety features, its environmental friendliness and low running costs for a long time to come.



## THE OWNER'S MANUAL CONTAINS...

... information, tips and important warnings regarding the safe, correct driving of your car, and its maintenance. Pay particular attention to the symbols  (personal safety)  (environmental protection)  (the car's wellbeing).



# DASHBOARD AND CONTROLS

DASHBOARD  
AND CONTROLS

SAFETY  
DEVICES

CORRECT USE  
OF THE CAR

WARNING  
LIGHTS AND  
MESSAGES

IN AN  
EMERGENCY

CAR  
MAINTENANCE

TECHNICAL  
SPECIFICATIONS

INDEX

DASHBOARD .....	5	CEILING LIGHTS.....	63
INSTRUMENT PANEL .....	6	CONTROLS.....	65
SYMBOLS .....	8	INTERIOR FITTINGS.....	67
THE FIAT CODE SYSTEM.....	8	SUNROOF.....	72
THE KEYS .....	10	DOORS .....	75
ALARM .....	16	POWER WINDOWS .....	77
IGNITION DEVICE.....	19	BOOT .....	79
INSTRUMENTS.....	20	BONNET .....	83
MULTIFUNCTION DISPLAY .....	22	ROOF RACK/SKI RACK .....	84
RECONFIGURABLE MULTIFUNCTION DISPLAY.....	23	HEADLIGHTS.....	85
TRIP COMPUTER .....	35	ABS SYSTEM .....	86
SEATS .....	37	ESP SYSTEM .....	88
HEAD RESTRAINTS.....	39	EOBD SYSTEM .....	91
STEERING WHEEL .....	40	SOUND SYSTEM.....	92
REARVIEW MIRRORS.....	40	INSTALLATION OF ELECTRIC/ELECTRONIC DEVICES .....	93
HEATING/CLIMATE CONTROL SYSTEM .....	42	“DUALDRIVE” ELECTRIC POWER STEERING SYSTEM .....	94
HEATING AND VENTILATION .....	44	TYRE PRESSURE MONITORING SYSTEM (T.P.M.S.) .....	96
MANUAL CLIMATE CONTROL SYSTEM .....	46	PARKING SENSORS .....	99
AUTOMATIC TWO-ZONE CLIMATE CONTROL SYSTEM .....	49	AT THE FILLING STATION .....	102
EXTERNAL LIGHTS .....	55	PROTECTING THE ENVIRONMENT .....	103
WINDOW WASHING.....	57		
CRUISE CONTROL .....	61		

# DASHBOARD

The presence and the position of the instruments and warning lights may vary according to the versions.

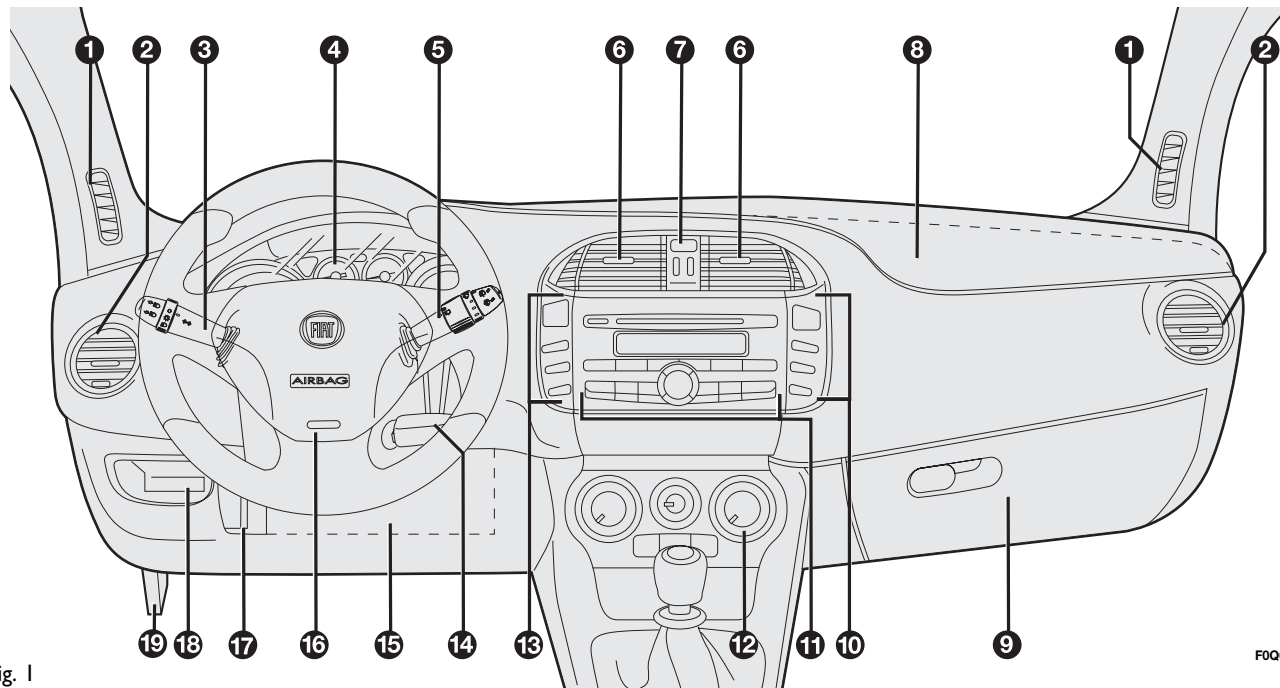

fig. 1

FOQ0639m

**1.** Side window air vent - **2.** Adjustable and swivel air vent - **3.** External light stalk - **4.** Instrument panel - **5.** Windscreen/rear window wiper/trip computer stalk - **6.** Adjustable and swivel air vents - **7.** Hazard light switch - **8.** Front passenger air bag - **9.** Glove box - **10.** Set of switches for front/rear fog lights and menu opening/setting - **11.** Sound system controls - **12.** Controls for heating/ventilation/climate control - **13.** Electric power steering/ASR system on/off switch unit (where fitted)/front parking sensors/boot opening (where fitted) - **14.** Ignition key and ignition device - **15.** Driver's knees air bag (where provided) - **16.** Driver's air bag - **17.** Steering wheel locking/release stalk - **18.** Fusebox access door - **19.** Bonnet opening lever

# INSTRUMENT PANEL

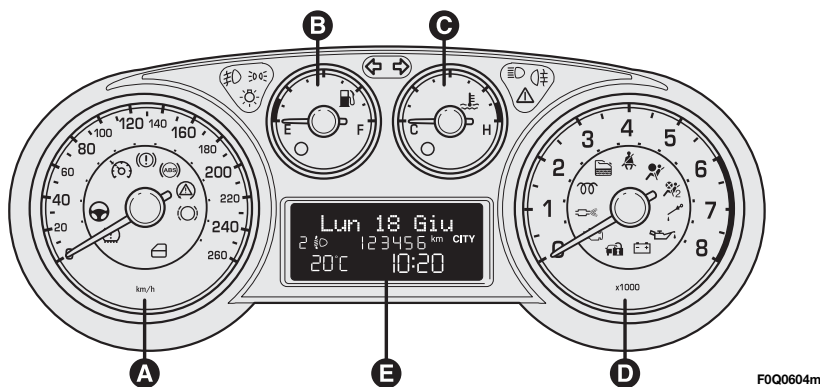

fig. 2

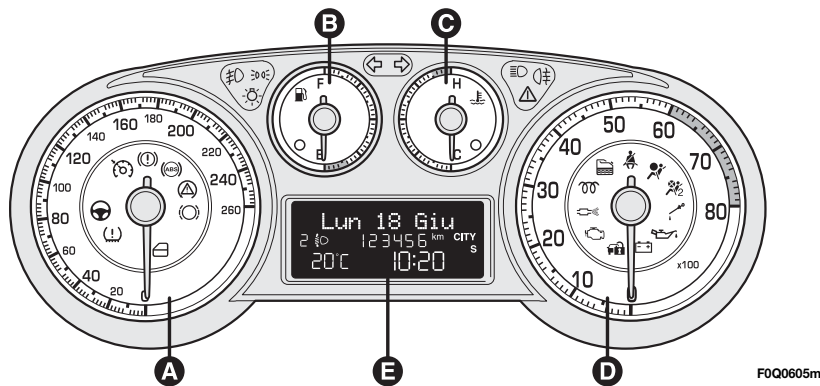

fig. 3

## Versions with multifunction display

- A** Speedometer (speed indicator)
- B** Fuel level gauge with reserve warning light
- C** Engine coolant temperature gauge and excessive temperature warning light
- D** Rev counter
- E** Multifunction display.

☞ ☞ Warning lights fitted on diesel versions only

On diesel versions the rev counter end scale value is 6000 rpm.



## Sport versions with multifunction display

- A** Speedometer (speed indicator)
- B** Fuel level gauge with reserve warning light
- C** Engine coolant temperature gauge and excessive temperature warning light
- D** Rev counter
- E** Multifunction display.

☞ ☞ Warning lights fitted on diesel versions only

On diesel versions the rev counter end scale value is 6000 rpm.

## Versions with reconfigurable multifunction display

- A Speedometer (speed indicator)
  - B Fuel level gauge with reserve warning light
  - C Engine coolant temperature gauge and excessive temperature warning light
  - D Rev counter
  - E Reconfigurable multifunction display.
-   Warning lights fitted on diesel versions only

On diesel versions the rev counter end scale value is 6000 rpm.

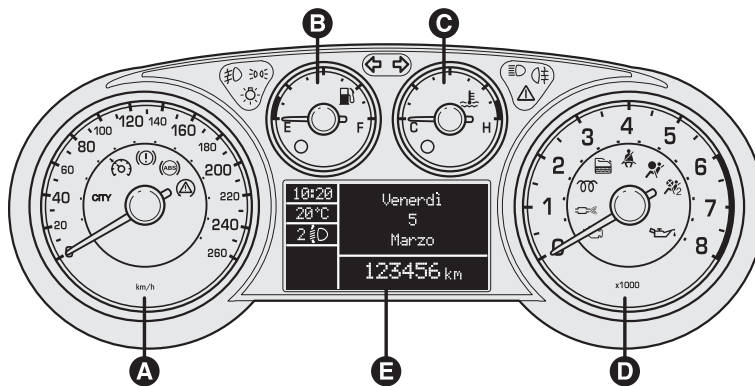



fig. 4

F0Q0612m

## Sport versions with reconfigurable multifunction display

- A Speedometer (speed indicator)
  - B Fuel level gauge with reserve warning light
  - C Engine coolant temperature gauge and excessive temperature warning light
  - D Rev counter
  - E Reconfigurable multifunction display.
-   Warning lights fitted on diesel versions only

On diesel versions the rev counter end scale value is 6000 rpm.

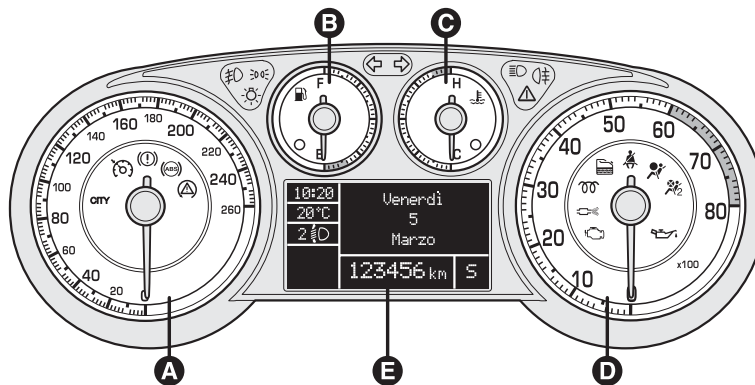

fig. 5

F0Q0613m



## SYMBOLS

Special coloured labels have been attached near or actually on some of the components of your car. These labels bear symbols that remind you of the precautions to be taken as regards that particular component.

The plate summarising the symbols used can be found under the bonnet **fig. 6**.

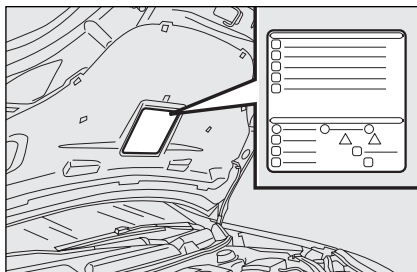

fig. 6

## THE FIAT CODE SYSTEM

To further protect your car from theft, it has been fitted with an engine immobilising system. This system is automatically activated when the ignition key is removed.

An electronic device, in fact, is fitted in each ignition key grip. The device transmits a radio-frequency signal when the engine is started through a special aerial built into the ignition switch. The modulated signal, which changes each time the engine is started, is the "password" by means of which the control unit recognises the key and enables to start the engine.

## OPERATION

Each time the car is started turning the ignition key to **MAR**, the Fiat CODE system control unit sends a recognition code to the engine control unit to deactivate the inhibitor.

The code is sent only if the Fiat CODE system control unit has recognised the code transmitted from the key.



Each time the ignition key is turned to **STOP**, the Fiat CODE system deactivates the functions of the engine electronic control unit.

If the code has not been recognised correctly, the instrument panel warning light  (or symbol on display) will turn on.

In this case, the key should be moved to the **STOP** position and then back to **MAR**; if the lock continues, possibly try again with the other key provided with the car. If it is still not possible to start the car contact a Fiat Dealership.

**IMPORTANT** Every key has its own code, which must be memorised by the system control unit. To memorise new keys, up to a maximum of eight, apply solely to Fiat Dealership taking with you the CODE card and the keys, a personal identity document and the car's ownership documents. The codes of the keys not provided during the new memorising procedure are erased from the memory. This is to ensure that any lost or stolen keys can no longer be used to start the car.

## Warning light (or symbol on display) coming on when driving

- If the warning light  (or symbol on display) turns on, this means that the system is running a self-test (for example for a voltage drop).
- If the warning light  (or symbol on display) continues to stay on, contact a Fiat Dealership.



***The electronic components inside the key may be damaged if the key is submitted to sharp knocks.***

## THE KEYS

### CODE CARD

Together with the keys you will receive the CODE card **fig. 7** to be presented to Fiat Dealership when requesting additional keys.

**IMPORTANT** In order to ensure perfect efficiency of the electronic devices contained inside the keys, they should never be exposed to direct sunlight.

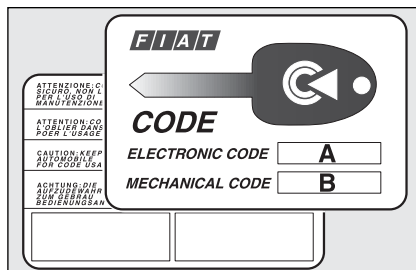

fig. 7

F0Q0001m



**All the keys and the CODE card must be handed over to the new owner when selling the car.**

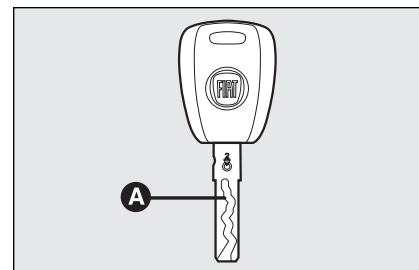

fig. 8

F0Q0034m

### KEY WITHOUT REMOTE CONTROL (where provided)

The key is fitted with a metal insert **A-fig. 8**, operating:

- the ignition switch
- doors and tailgate locks
- the fuel lid locking/unlocking (on versions featuring fuel filler cap with lock)
- the safe lock device (only disengagement - where provided)

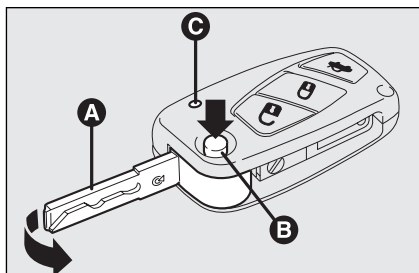



fig. 9

F0Q0327/m

## KEY WITH REMOTE CONTROL

The key is fitted with a metal insert **A**-fig. 9, operating:

- the ignition switch
- doors and tailgate locks
- the fuel lid locking/unlocking
- the safe lock device (only disengagement - where provided)



Button  for remote unlocking of doors and tailgate.

Button  for remote locking of doors and tailgate.

Button  for remote opening of the tailgate. Button **B** for power-assisted opening of the metal insert **A**.

To refit the metal insert into the key grip, keep button **B** pressed and turn the metal insert in the direction shown by the arrow until hearing the click as it locks into place. Then release button **B**. Led **C** (where provided) comes on when sending the control to the alarm system receiver. To know the operating logics of the key with remote control and every possible and modifiable setting, see paragraph “Alarm” in this section.



**If locking button  is inadvertently pressed from the passenger compartment, when getting out of the car only the doors being used will unlock; the tailgate will stay locked. To realign the system, press again the locking/unlocking buttons  / .**



### WARNING

**Button B-fig. 9 should only be pressed when the key is away from the body, in particular from the eyes and from objects that can be spoiled (e.g. clothes). Make sure the key can never be touched by others, especially children, who may inadvertently press the button.**

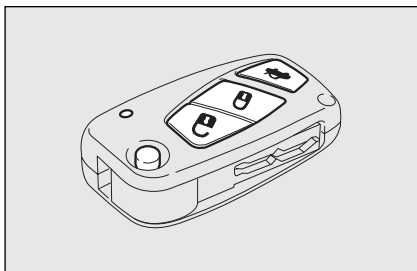



fig. 10

F0Q0408m

### Opening the doors and the tailgate

Briefly press button  for remote unlocking of doors and tailgate and simultaneous alarm (where provided) deactivation, timed switching on of the internal ceiling lights and double flashing of direction indicators (for versions/markets where applicable).

Press button  for more than 2 seconds to open the windows.

Doors will be unlocked automatically if the fuel inertial cut-off switch comes into operation.

### Closing the doors and the tailgate

Briefly press button  for remote locking of doors and tailgate and simultaneous alarm (where provided) activation, switching off of the internal ceiling lights and single flashing of direction indicators.

Press button  for more than 2 seconds to close the windows. If the button is briefly pressed twice, the safe lock device (where provided) is activated (see next paragraph "Safe lock device").

If one or more doors are open, locking will not be activated and the central panel led **A-fig. 11** and direction indicators will flash rapidly. If only the tailgate is open the doors will lock.

### Opening the tailgate by the remote control

Press button  to open the tailgate by remote control even if the alarm (where provided) is on.

Opening the tailgate is accompanied by the direction indicators flashing twice; closing is accompanied by a single flash only if the alarm is on.

Opening the tailgate (with alarm on) will obtain the deactivation of boot volumetric protection and perimetral sensor.

Closing the tailgate will reactivate boot volumetric protection and perimetral sensor.

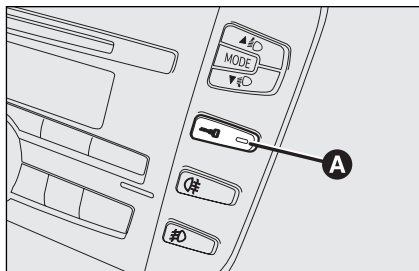

fig. 11

F0Q0742m

### Leds on central panel

When locking the doors, led **A**-fig. 11 switches on for about 3 seconds and then starts flashing (deterrence function).

Once doors are locked, if one or more doors or the tailgate are not closed correctly, the led and direction indicators start flashing quickly.

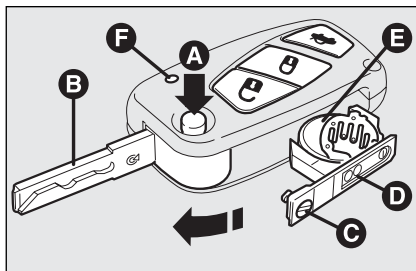







fig. 12

F0Q0037m

### Replacing the battery of the key with remote control

If, when pressing button , , or , the led **F**-fig. 12 (where provided) on the key flashes briefly only once, the battery should be replaced with an equivalent one that can be purchased at common stores.

Battery replacement:

- press button **A** and open the metal insert **B**;
- turn the screw **C** to  using a fine bit screwdriver;
- take out the battery case **D** and replace the battery **E** making sure that the bias is correct;
- re-insert the battery holder **D** in the key and lock it turning the screw **C** to .

### Request for additional remote controls

The system can recognise up to 8 remote controls. Should a new remote control be necessary, contact a Fiat Dealership, taking with you the CODE card, a personal identity document and the car's ownership documents.



**Used batteries are harmful to the environment. They should be disposed of as specified by law in the special containers provided, or take them to a Fiat Dealership, which will deal with their disposal.**

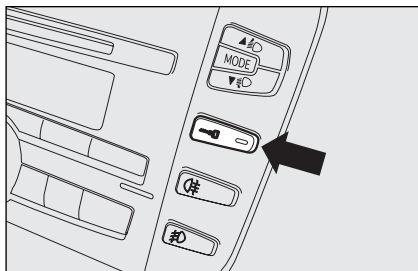

fig. 13

F0Q0641m

## SAFE LOCK DEVICE (where provided)

This safety device enables to inhibit:

- door internal handles;
- button **fig. 13** for locking/unlocking the doors, placed on the central panel;

thus hindering doors opening from inside the passenger's compartment in case of attempt to break-into (e.g. window breaking).

The safe lock device guarantees the best protection against unwanted access. Therefore, it should be actuated every time the car is parked and left unattended.



### WARNING

*Once the safe lock device has been actuated, doors cannot be opened from inside the car in any way whatsoever. For this reason, make sure there are no persons left inside the car.*



### WARNING

*If the battery of the key with remote control is down, the safe lock device can only be activated through the metal insert of the key in the revolving plugs of the doors as described previously: in this case the safe lock device is active only on the rear doors.*

## Device activation

The device is automatically activated on every door by pressing twice button **L** on the key with remote control.

Device activation is signalled by three flashes of the direction indicators and flashing of the door-lock button led on the dashboard (see table on next page).







If one of the doors is not perfectly closed, the dead lock device will not activate, thus preventing that a person getting into the car from the open door remains blocked inside the passenger's compartment when she/he closes the door.

## Device deactivation

The device is deactivated automatically on every door in the following cases:

- when unlocking the doors;
- when turning the ignition key to **MAR**.

The main functions that can be activated with the keys (with or without remote control) are the following:

Type of key	Door opening	Door closing	Window opening	Window closing	Safe lock (where provided)	Tailgate opening
Key without remote control (where provided)	Key turning counterclockwise (driver side) or clockwise (passenger side) (where provided)	Key turning clockwise (driver side) or counterclockwise (passenger side) (where provided)	-	-	-	-
Key with remote control	Key turning counterclockwise (driver side) or clockwise	Key turning clockwise (driver side) or counterclockwise	-	-	-	-
	Pressing briefly button 	Pressing briefly button 	Prolonged pressing (> 2 seconds) on button 	Prolonged pressing (> 2 seconds) on button 	Double pressing on button 	Press button 
Direction indicators flashing (only with key with remote control)	2 flashings	1 flashing	2 flashings	1 flashing	3 flashings	2 flashings
Led on central dashboard	Deterrence led turning off	Turned on fixed for approx. 3 seconds followed by deterrence led flashing	Turning off deterrence led	Deterrence led flashing	Double flashing and then deterrence led flashing	Deterrent led flashing



## ALARM (where provided)

The alarm function is provided in addition to all remote control functions previously described and it is controlled by the receiver located under the dashboard, next to the fuse box.

### WHEN THE ALARM IS TRIGGERED

The alarm comes into action in the following cases:

- unlawful opening of one of the doors, bonnet or boot (perimetral protection);
- attempt to start the engine (turning the ignition key to **MAR**);
- battery cable cutting;
- presence of moving bodies in the passenger's compartment (volumetric protection);
- abnormal raising/sloping of the car.

Depending on the markets, the cutting in of the alarm causes operation of the siren and direction indicators (for about 26 seconds). The ways of operating and the number of cycles may vary depending on the markets.

A maximum number of sound/sight cycles is however envisaged.

The volume sensing and anti-lift protections may be turned off by operating the control on the front courtesy light (see "Volume-sensing/anti-lift protection" paragraph).



**IMPORTANT** The engine immobiliser function is guaranteed by the Fiat CODE system, which is automatically activated when the ignition key is removed.

## HOW TO ACTIVATE THE ALARM

With the doors, bonnet and boot shut and the ignition key in the **STOP** position or with the key removed, point the key with remote control in the direction of the car, then press and release the button .

With the exception of certain markets, the system sounds a “beep” and the doors are locked.

Engagement of the alarm is preceded by a self-diagnostic test. If a fault is detected the system sounds a further warning “beep” and the display shows the relevant message (see section “Warning lights and messages”).

In this case, switch the alarm system off by pressing button , check that the doors, bonnet and tailgate are properly shut, then switch the alarm on again by pressing button .

Otherwise, the door, bonnet or tailgate that is not shut properly will be excluded from the alarm system control.

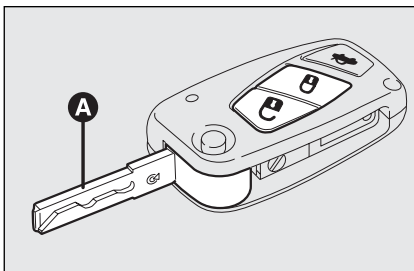

fig. 14

F0Q0335m

If the doors, bonnet and boot are shut correctly and the control signal is repeated, the system self-diagnostics has detected a system operating fault. It is therefore necessary to contact Fiat Dealership.

**IMPORTANT** When operating the central door locking with the metal insert **A**-**fig. 14** of the key, the alarm is not activated.

**IMPORTANT** The electronic alarm is built in compliance with the law and regulations of the different countries.

## HOW TO DEACTIVATE THE ALARM

Press button  of the key with remote control.

The system will react as follows (with the exception of certain markets):

- two brief flashes of the direction indicators;
- two brief “beeps”;
- door unlocking.

**IMPORTANT** Operating the central door locking with the metal insert of the key will not deactivate the alarm.

## VOLUME-SENSING/ ANTI-LIFT PROTECTION

To ensure correct operation of the protection, it is advisable to fully close the side windows and sun-roof (where fitted).

If necessary, the function may be turned off (e.g. if animals are left in the car) by pressing key **A**-fig. 15, located on the front courtesy light before activating the alarm.

Function deactivation is indicated by the led located on the key flashing for a few seconds. If the volume-sensing/anti-lift protection is turned off, this must be repeated whenever the instrument panel is turned off.

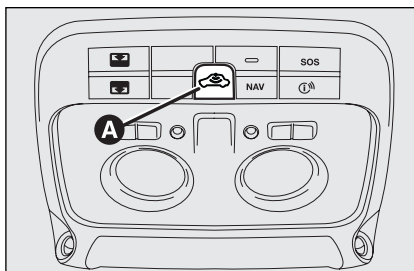



fig. 15

F0Q0752m

## INDICATIONS OF ATTEMPTS TO BREAK IN

Any attempt to break in is indicated by warning light  (or symbol on display) on the instrument panel with the relevant message on the display (see section “Warning lights and messages”).

## HOW TO CUT OFF THE ALARM SYSTEM

To deactivate the alarm system completely (for instance during prolonged inactivity of the car) simply lock the car turning the metal insert of the key with remote control in the lock.

**IMPORTANT** To cut-out the electronic alarm if remote control batteries are down or the system is failing, fit the key into the ignition switch and turn it to **MAR**.

## IGNITION SWITCH

The key can be turned to 3 different positions **fig. 16**:

- STOP**: engine off, key can be removed, steering column locked. Certain electrical devices (e.g.: sound system, central door locking, electronic alarm, etc.) can work.
- MAR**: driving position. All electrical devices are powered.
- AVV**: engine starting.

The ignition switch is fitted with a safety mechanism that, in the event the engine is not started, compels the driver to turn the ignition key back to **STOP** before repeating the starting operation.

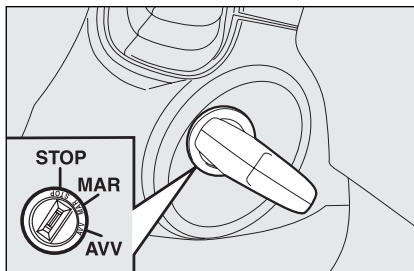

fig. 16

FOQ0642m



### WARNING

*If the ignition device is tampered with (e.g.: attempted theft), have it checked over by a Fiat Dealership before restarting to drive.*



### WARNING

*When getting out of the car, always remove the key to prevent any occupants from accidentally activating the controls. Remember to engage the handbrake and if the car is parked on uphill slope to engage the first gear. If the car is facing downhill, engage the reverse gear. Never leave unsupervised children in the car.*

## STEERING COLUMN LOCK

### Engaging

When the key is at **STOP** remove the key and turn the steering wheel until it locks.

### Disengaging

Rock the steering wheel slightly as you turn the ignition key to **MAR**.



### WARNING

*It is absolutely forbidden to carry out whatever after-market operation involving steering system or steering column modifications (e.g.: installation of anti-theft device) that could badly affect performance and safety, cause the lapse of warranty and also result in non-compliance of the car with homologation requirements.*



### WARNING

*Never remove the ignition key while the car is moving. The steering wheel would automatically lock as soon as you try to turn it. This also applies when the car is being towed.*

## INSTRUMENTS

Instrument background color and type may vary according to the version.

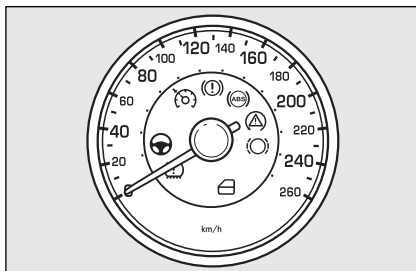

fig. 17

F0Q0606m

### SPEEDOMETER fig. 17

It shows the car speed.

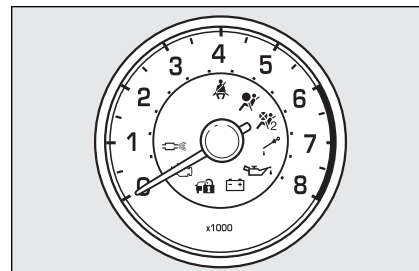

fig. 18

F0Q0607m

### REV. COUNTER fig. 18

Rev counter shows engine rpm.

On diesel versions the rev counter end scale value is 6000 rpm.

**IMPORTANT** The electronic injection control system gradually shuts off the flow of fuel when the engine is “over-revving” resulting in a gradual loss of engine power.

When the engine is idling, the rev counter may indicate a gradual or sudden speed increase. This is normal as it takes place during normal operation, for example when activating the climate control system or the fan. In particular a slow change in the speed preserves the battery charge.

## FUEL LEVEL GAUGE

This shows the amount of fuel left in the fuel tank.

The reserve warning light **A-fig. 19** turns on to indicate that approx. 8-10 litres of fuel are left in the tank.

**E** - tank empty.

**F** - tank full (see contents of "At the filling station" paragraph in this chapter).

Do not travel with the tank almost empty because the catalytic converter could become damaged.

**IMPORTANT** The needle sets to **E** with warning light **A** flashing to indicate that the system is failing. In this event contact Fiat Dealership to have the system checked.

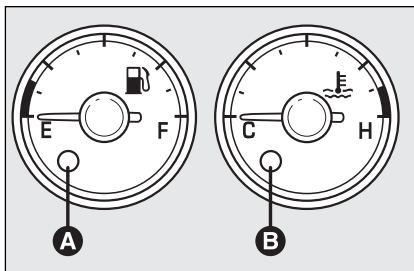

fig. 19

F0Q0608m

## ENGINE COOLANT TEMPERATURE GAUGE

This shows the temperature of the engine coolant fluid and begins working when the fluid temperature exceeds approx. 50°C.

Under normal conditions, the needle should move to different positions of the scale according to the conditions of use of the car.

**C** - Low engine coolant temperature.

**H** - High engine coolant temperature.

The turning on of the warning light **B-fig. 19** (together with the message shown on the display) indicates that the coolant fluid temperature is too high; in this case, stop the engine and contact a Fiat Dealership.



*If the needle reaches the red area, stop the engine immediately and contact a Fiat Dealership.*

## MULTIFUNCTION DISPLAY (where provided)

Your car is fitted with the multifunction display that shows all the useful information necessary when driving.

### INFORMATION ON “STANDARD” SCREEN fig. 20

The standard screen shows the following indications:

- A** Date
- B** Dualdrive electric power steering engagement, if any
- C** Sport function indication (where provided)
- D** Clock
- E** Odometer (covered km or miles)
- F** Warning of ice on road
- G** External temperature
- H** Scheduled servicing
- I** Headlight aiming position (only with dipped beam headlights on)

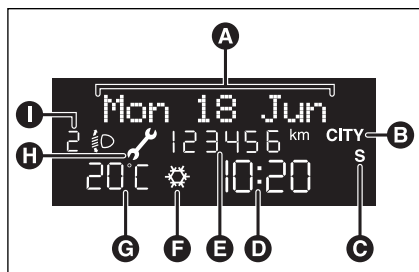

fig. 20

F0Q3245g

### CONTROL BUTTONS fig. 21

**▲** To scroll the display and the related options upwards or to increase the value displayed.

**MODE** Brief press to open the menu and/or to move to next screen or to confirm the option required.

Long press to go back to the standard screen.

**▼** To scroll the display and the related options downwards or to decrease the value displayed.

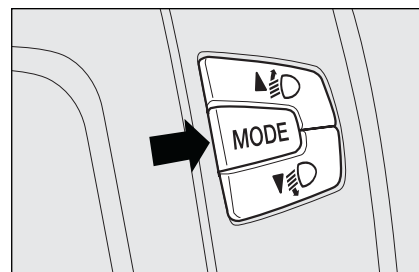

fig. 21

F0Q0643m

**Note** Buttons ▲ and ▼ activate different functions according to the following situations:

– to scroll the menu options upwards and downwards;

– to increase or to decrease values during settings.

**Note** When opening one of the front doors the display will show for a few seconds the clock and covered km or miles.

## RECONFIGURABLE MULTIFUNCTION DISPLAY (where provided)

The car can be provided with the reconfigurable multifunction display that shows useful information, according to the previous settings made, necessary when driving.

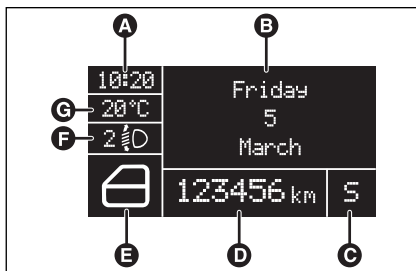

fig. 22

F0Q3268g

### INFORMATION ON “STANDARD” SCREEN fig. 22

The standard screen shows the following indications:

- A** Clock
- B** Date
- C** Sport function indication (where provided)
- D** Odometer (covered km or miles)
- E** Indications about car conditions (e.g.: doors open, or possible presence of ice on road, etc. ...)
- F** Headlight aiming position (only with dipped beam headlights on)
- G** External temperature

On I.4 T-JET versions, selecting the menu item “Engine info”, when turning start-up key to **MAR** position, the display shows engine oil pressure **fig. 22a**.

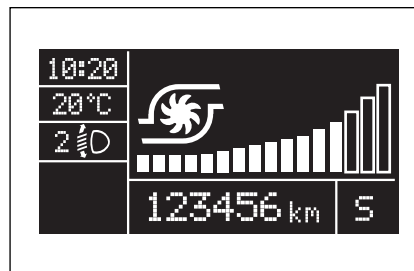

fig. 22a

F0Q0041m

### CONTROL BUTTONS fig. 23

**Δ** To scroll the display and the related options upwards or to increase the value displayed.

**MODE** Brief press to open the menu and/or to move to next screen or to confirm the option required.

Long press to go back to the standard screen.

**∇** To scroll the display and the related options downwards or to decrease the value displayed.

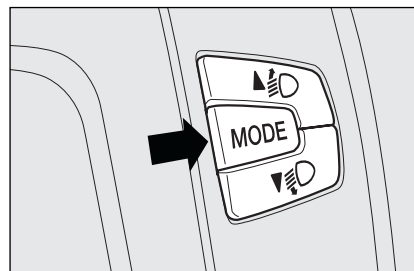

fig. 23

F0Q0643m

**Note** Buttons **Δ** and **∇** activate different functions according to the following situations:

- to scroll the menu options upwards and downwards;
- to increase or to decrease values during settings.

**Note** When opening one of the front doors the display will show for a few seconds the clock and covered km or miles.



## SETUP MENU fig. 24-25

The menu comprises a series of functions arranged in a “circular fashion” which can be selected through buttons  $\Delta$  and  $\nabla$  to access the different select operations and settings (setup) given below. For certain options (Set time and Units) there is a submenu.

The setup menu can be activated by pressing briefly button **MODE**.

Single presses on buttons  $\Delta$  or  $\nabla$  will scroll the setup menu options. Handling modes differ with each other according to the characteristic of the option selected.

If the car is equipped with Connect Nav+, the only functions that can be adjusted/set through the instrument panel display are the following: “Dimmer”, “Speed Beep”, “Headl. sensor” (where provided), “Belt buzzer” and “Passenger bag”. The other functions are displayed by and can be adjusted/set through the Connect Nav+ system display.

*Selecting an option in the main menu without submenu:*

- press briefly button **MODE** to select the menu option to set;
- press buttons  $\Delta$  or  $\nabla$  (by single presses) to select the new setting;
- press briefly button **MODE** to store the new setting and to go back to the previously selected menu option.

*Selecting an option in the main menu with submenu:*

- press briefly button **MODE** to display the first submenu option;
- press buttons  $\Delta$  or  $\nabla$  (by single presses) to scroll all submenu options;
- press briefly button **MODE** to select the displayed submenu option and to enter the relevant setup menu;
- press buttons  $\Delta$  or  $\nabla$  (by single presses) to select the new setting;
- press briefly button **MODE** to store the new setting and to go back to the previously selected submenu option.

**Versions with multifunction display**

**Example:**

Briefly press button **MODE** to start surfing from the standard screen. To surf the menu use buttons **Δ** or **∇**. **Note** For safety reasons, when the car is running, it is possible to access only the reduced menu (for setting "Dimmer" and "Speed BEEP"). When the car is stationary access to the whole menu is enabled. On cars provided with Connect Nav+ many functions are displayed on the navigator display.

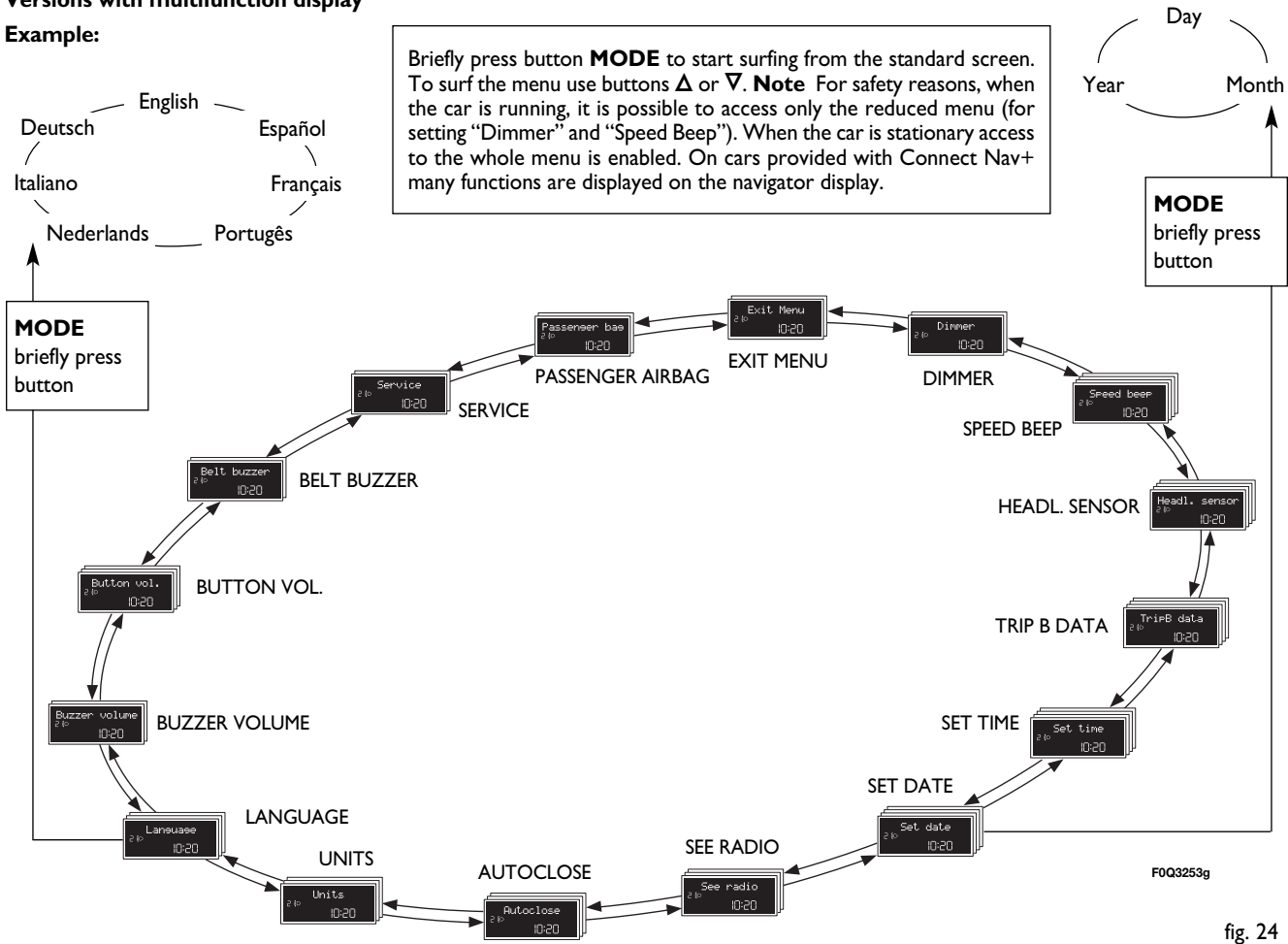

- DASHBOARD AND CONTROLS
- SAFETY DEVICES
- CORRECT USE OF THE CAR
- WARNING LIGHTS AND MESSAGES
- IN AN EMERGENCY
- CAR MAINTENANCE
- TECHNICAL SPECIFICATIONS
- INDEX

fig. 24

## Versions with reconfigurable multifunction display

Example:

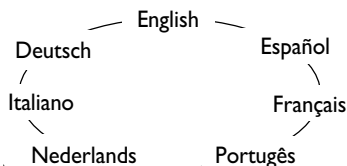

Briefly press button **MODE** to start surfing from the standard screen. To surf the menu use buttons  $\Delta$  or  $\nabla$ . **Note** For safety reasons, when the car is running, it is possible to access only the reduced menu (for setting "Dimmer" and "Speed BEEP"). When the car is stationary access to the whole menu is enabled. On cars provided with Connect Nav+ many functions are displayed on the navigator display.

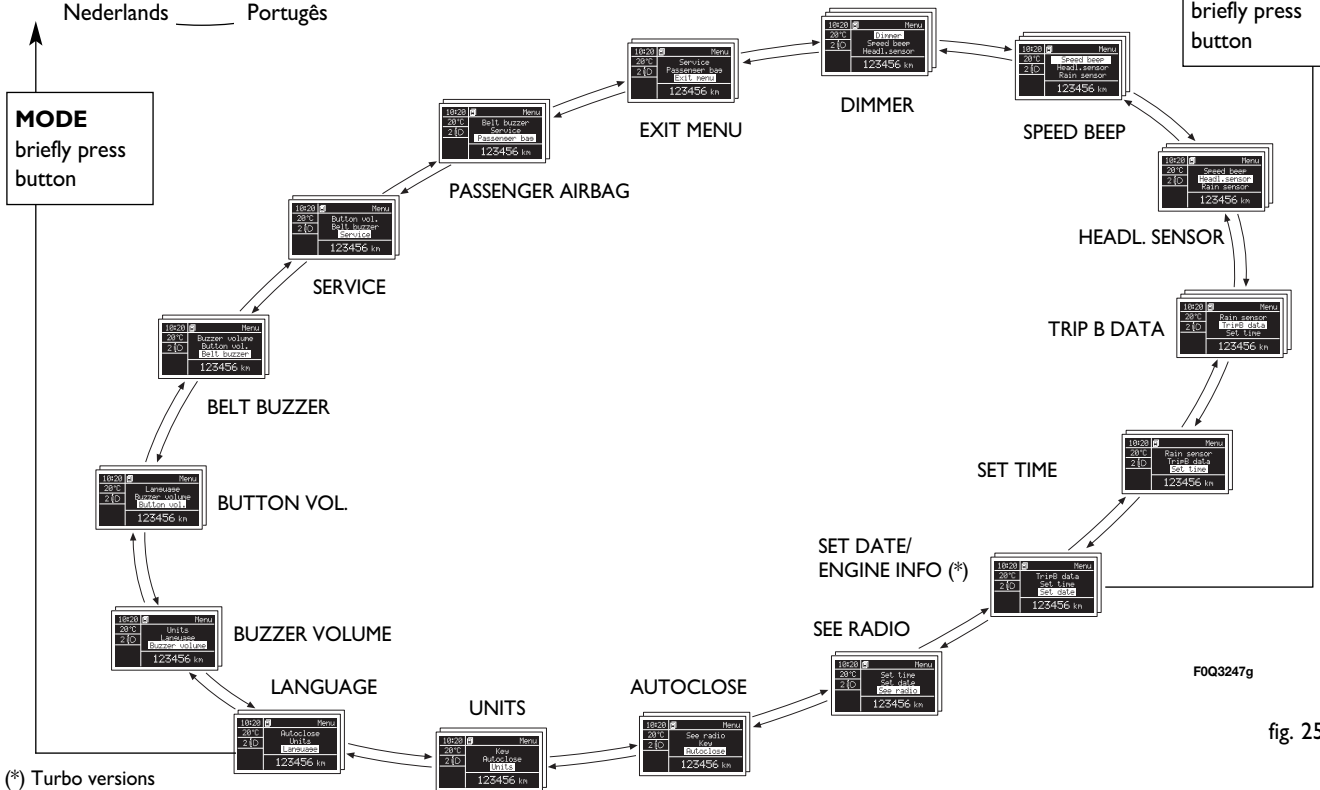
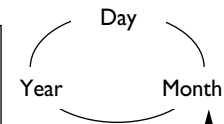

(\*) Turbo versions

fig. 25

## Dimmer (Passenger compartment control light rheostat) (only with side/taillights on)

With this function it is possible to adjust brightness of the instrument panel and of buttons and controls of sound system and automatic climate control system (where provided) according to 8 levels (with side/taillights on).

To adjust brightness proceed as follows:

- briefly press button **MODE**, the previously set level will flash on the display;
- press button  $\Delta$  or  $\nabla$  to adjust the brightness level;
- briefly press button **MODE** to go back to the menu screen or press the button for long to go back to the standard screen without storing settings.

## Speed Beep (Speed limit)

With this function it is possible to set the car speed limit (km/h or mph); when this limit is exceeded the driver is immediately alerted (see section “Warning lights and messages”).

To set the speed limit, proceed as follows:

- briefly press button **MODE**, the display will show wording (Speed Beep);
- press button  $\Delta$  or  $\nabla$  to select activation (On) or deactivation (Off) of the speed limit;
- if selecting (On), press button  $\Delta$  or  $\nabla$  to select the required speed limit and then press **MODE** to confirm.

**Note** The possible setting is between 30 and 200 km/h, or between 20 and 125 mph depending on the unit set previously (see “Distance unit (Dist. Unit)” paragraph described later. Every press on button  $\Delta/\nabla$  increases/decreases by 5 units. Keeping the button  $\Delta/\nabla$  pressed obtains the automatic fast increase or decrease. When you are near the required setting complete adjustment by single presses.

- briefly press button **MODE** to go back to the menu screen or press the button for long to go back to the standard screen without storing settings.

To cancel the setting, proceed as follows:

- briefly press button **MODE**: (On) will flash on the display;
- press button  $\nabla$ : (Off) will flash on the display;
- briefly press button **MODE** to go back to the menu screen or press the button for long to go back to the standard screen without storing settings.

## Headl. sensor (Automatic headlight sensor sensitivity adjustment) (where provided)

With this function it is possible to adjust the light sensor sensitivity according to 3 levels (level 1 = min. level, level 2 = average level, level 3 = max. level); the higher the sensitivity is, the lower is the external light intensity required to switch on the lights.

To set the light level required, proceed as follows:

- briefly press button **MODE**, the previously set level will flash on the display;
- press button **Δ** or **∇** to select the required level;
- briefly press button **MODE** to go back to the menu screen or press the button for long to go back to the standard screen without storing settings.

## Trip B data (Trip On/Off)

Through this option it is possible to activate (On) or deactivate (Off) the Trip B (partial trip).

For further information see “Trip computer”.

For activation / deactivation, proceed as follows:

- briefly press button **MODE**: On or Off will flash on the display according to previous setting;
- press button **Δ** or **∇** to select the required level;
- briefly press button **MODE** to go back to the menu screen or press the button for long to go back to the standard screen without storing settings.

## Set time (Setting the clock)

This function enables to set the clock through two sub-menus: “Time” and “Mode”.

Proceed as follows:

- briefly press button **MODE**, the display will show the two submenus “Time” and “Mode”;
- press button **Δ** or **∇** to scroll the two submenus;
- select the required submenu and then press briefly **MODE**;
- if selecting “Time”: briefly press button **MODE**, “hours” will flash on the display;
- press button **Δ** or **∇** for setting;
- press button **MODE**, “minutes” will flash on the display;
- press button **Δ** or **∇** for setting.

**Note** Every press on button  $\Delta$  or  $\nabla$  increases/decreases by 1 unit. Keeping the button pressed obtains automatic fast increase or decrease. When you are near the required setting complete adjustment by single presses.

– if selecting “Mode”: briefly press button **MODE**, “24h” or “12h mode will flash on the display;

– press button  $\Delta$  or  $\nabla$  to select “24h” or “12h”.

After setting, briefly press button **MODE** to go back to the submenu screen or press the button for long to go back to the main menu screen without storing settings.

– press again button **MODE** for long to go back to the standard screen or to the main menu according to the current menu level.

## Set date (Setting the date)

This function enables to update the date (day – month – year).

To correct the date proceed as follows:

– briefly press button **MODE**: “year” will flash on the display;

– press button  $\Delta$  or  $\nabla$  for setting;

– briefly press button **MODE**: “month” will flash on the display;

– press button  $\Delta$  or  $\nabla$  for setting;

– briefly press button **MODE**: “day” will flash on the display;

– press button  $\Delta$  or  $\nabla$  for setting.

**Note** Every press on button  $\Delta$  or  $\nabla$  increases/decreases by 1 unit. Keeping the button pressed obtains automatic fast increase or decrease. When you are near the required setting complete adjustment by single presses.

– briefly press button **MODE** to go back to the menu screen or press the button for long to go back to the standard screen without storing settings.

## Engine oil information (Engine info) (where provided)

You can display engine oil information (pressure) in place of the date. Follow the instructions below to turn on/off engine oil information display:

– briefly press button **MODE**: on the display you will see “Engine info repetition”;

– press button  $\Delta$  or  $\nabla$  and select “ON” to turn on or “OFF” to turn off;

– briefly press button **MODE** in order to return to the menu screen or keep the pushbutton pressed in order to return to the standard screen without memorizing.

Turn the ignition key on **MAR**, after the initial check stage the multifunction display that can be reconfigured, will show (if previously enabled) engine oil information.

## See radio (Audio repetition)

With this function the display repeats information relevant to the sound system.

- Radio: selected radio station frequency or RDS message, automatic tuning activation or AutoSTore;

- audio CD, MP3 CD: track number;

- CD Changer: CD number and track number;

To activate (On) or to deactivate (Off) sound system info displaying proceed as follows:

- briefly press button **MODE**: On or Off will flash on the display according to previous setting;

- press button **Δ** or **∇** to select the required level;

- briefly press button **MODE** to go back to the menu screen or press the button for long to go back to the standard screen without storing settings.

## Autoclose (Automatic central door locking when travelling)

When activated (On), this function locks automatically the doors when the car speed exceeds 20 km/h.

To activate or to deactivate this function proceed as follows:

- briefly press button **MODE** to display the submenu;

- briefly press button **MODE**: On or Off will flash on the display according to previous setting;

- press button **Δ** or **∇** to select the required level;

- briefly press button **MODE** to go back to the menu screen or press the button for long to go back to the standard screen without storing settings;

- Press again button **MODE** for long to go back to the standard screen or to the main menu according to the current menu level.

## Units (Setting units)

With this function it is possible to set the units through three submenus: “Distances”, “Consumption” and “Temperature”.

To set the required unit proceed as follows:

- briefly press button **MODE**, the display will show the three submenus;

- press button **Δ** or **∇** to scroll the three submenus;

- select the required submenu and then press briefly button **MODE**;

- if selecting “Distances”: pressing button **MODE** briefly, the display will show “km” or “mi” according to previous setting;

- press button **Δ** or **∇** to select the required level;

- if selecting “Consumption”: briefly press button **MODE** the display will show “km/l”, “l/100km” or “mpg” according to previous setting;

If the distance unit set is “km” the fuel consumption unit will be displayed in km/l or l/100km.

If set unit is “mi” the display will show fuel consumption in “mpg”.

– press button **Δ** or **∇** to select the required level;

– if selecting “Temperature”: pressing button **MODE** briefly, the display will show “°C” or “°F” according to previous setting;

– press button **Δ** or **∇** to select the required level;

After setting, briefly press button **MODE** to go back to the submenu screen or press the button for long to go back to the main menu screen without storing settings.

– press again button **MODE** for long to go back to the standard screen or to the main menu according to the current menu level.

## Language (Selecting the language)

Display messages can be shown (after setting) in different languages: Italian, German, English, Spanish, French, Portuguese and Dutch.

To set the required language proceed as follows:

– briefly press button **MODE**: the previously set “language” will flash on the display;

– press button **Δ** or **∇** to select the required level;

– briefly press button **MODE** to go back to the menu screen or press the button for long to go back to the standard screen without storing settings.

## Buzzer volume (Setting the buzzer volume)

With this function the volume of the buzzer accompanying any failure/warning indication can be adjusted according to 8 levels.

To adjust the volume proceed as follows:

– briefly press button **MODE**: the previously set volume “level” will flash on the display;

– press button **Δ** or **∇** for setting;

– briefly press button **MODE** to go back to the menu screen or press the button for long to go back to the standard screen without storing settings.



### Button vol. (Adjusting the button volume)

With this function the volume of the roger-beep accompanying the activation of buttons **MODE**, **Δ** and **∇** can be adjusted according to 8 levels.

To adjust the volume proceed as follows:

- briefly press button **MODE**: the previously set volume “level” will flash on the display;
- press button **Δ** or **∇** for setting;
- briefly press button **MODE** to go back to the menu screen or press the button for long to go back to the standard screen without storing settings.

### Belt Buzzer (S.B.R. buzzer reactivation)

This function can be only displayed after Fiat Dealership has deactivated the S.B.R. system (see paragraph “S.B.R. system” in section “Safety devices”).

### Service (Scheduled Servicing)

Through this function it is possible to display information connected to proper car servicing.

Proceed as follows:

- briefly press button **MODE**: service in km or mi, according to previous setting, will be displayed (see paragraph “Distance unit”);
- briefly press button **MODE** to go back to the menu screen or press the button for long to go back to the standard screen without storing settings.

**Note** The “Service schedule” includes car maintenance every 30,000 km (or 18,000 miles) or every year; this is shown automatically, with the ignition key at **MAR**, starting from 2,000 km (or equivalent value in miles) or 30 days from this deadline and it is shown again every 200 km (or equivalent value in miles). Below 200 km servicing indications are displayed more frequently. Servicing indication will be displayed in km or mi according to previous setting. When a programmed maintenance interval (coupon) is near to come, turning the ignition key to **MAR**, the display will show the message “Service” followed by the number of km/mi or days to go before car servicing. Contact a Fiat Dealership to carry out any service operation provided by the “Service schedule” and to reset the display.

## Passenger's Bag (Front passenger's air bag and side bag, where provided, activation/deactivation)

This function shall be used to activate/de-activate the front passenger's air bag.

Proceed as follows:

- press button **MODE** and, after displaying of messages (Bag pass: Off) (to deactivate) or (Bag pass: On) (to activate) by pressing buttons **▲** and **▼**, press again button **MODE**;

- display will show the confirmation message;

- press buttons **▲** or **▼** to select (Yes) (to confirm activation/deactivation) or (No) (to abort);

- briefly press button **MODE**, to display the confirmation message and to go back to the menu screen or press the button for long to go back to the standard screen without storing settings.



▲  
▼  
MODE



▲  
▼  
MODE

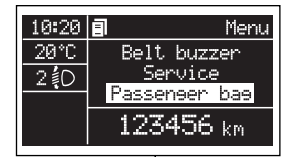

▲  
▼  
MODE

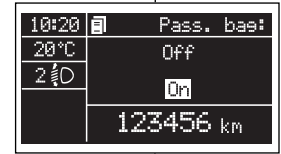

▲  
▼  
MODE

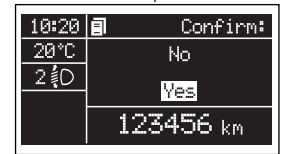

## Exit Menu

This is the last function that closes the circular setting cycle listed in the initial menu screen.

Briefly press button **MODE** to go back to the standard screen without storing settings.

Press button **∇** to return to the first menu option (Speed Beep).

## TRIP COMPUTER

### General features

The “Trip computer” displays information (with ignition key at **MAR**), relating to the operating status of the car. This function comprises two separate and independent trips: “Trip A” and “Trip B” concerning the “complete mission” of the car (journey).

Both functions are resettable (reset - start of new mission).

“Trip A” shall be used to display the figures relating to:

- Range
- Trip distance
- Average consumption
- Instant consumption
- Average speed
- Travel time (driving time).

“Trip B” displays the figures relating to:

- Trip distance B
- Average consumption B
- Average speed B
- Travel time B (driving time).

**Note** “Trip B” function can be excluded (see paragraph “Trip B On/Off”). “Range” and “Instant consumption” cannot be re-set.

## Values displayed

### *Range*

This value shows the distance in km (or mi) that the car can still cover before needing fuel, assuming that driving conditions are kept unvaried. The display will show “----” in the following cases:

- value lower than 50 km (or 30 mi)
- car left parked with engine running for long.

**IMPORTANT** The variation of the autonomy value can be influenced by different factors: driving style (see what is described in paragraph “Driving style” in the chapter “Start-up and driving”), type of route (highways, urban, mountain, etc...), use conditions of the car (load transported, tire pressure, etc...). What was described previously must be taken in consideration when planning a trip.

### *Trip distance*

This value shows the distance covered from the start of the new mission.

### *Average consumption*

This value shows the average consumption from the start of the new mission.

### *Instant consumption*

Represents the indicative average of consumptions from the beginning of the new mission.

### *Average speed*

This value shows the car average speed as a function of the overall time elapsed since the start of the new mission.

### *Travel time*

This value shows the time elapsed since the start of the new mission.

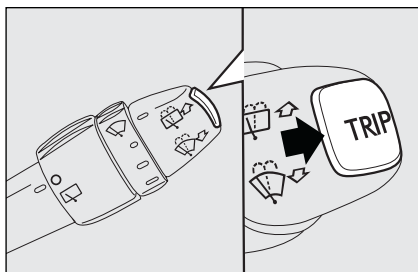

fig. 26

F0Q0647m

### TRIP button fig. 26

The **TRIP** button, set on right steering column stalk, shall be used (with ignition key at **MAR**), to display and to reset the previously described values to start a new mission:

- short push to display the different values;
- long push to reset and then start a new mission.

### New mission

Reset can be:

- “manual” resetting by the user, by pressing the relevant button;
- “automatic” resetting, when the “trip distance” reaches 9999,9 km or when the “trip time” reaches 99.59 (99 hours and 59 minutes);
- after disconnecting/reconnecting the battery.

**IMPORTANT** The reset operation in the presence of the screens concerning the “Trip A” makes it possible to reset only the information associated with this function.

**IMPORTANT** The reset operation in the presence of the screens concerning the “Trip B” makes it possible to reset only the information associated with this function.

### Start of journey procedure

With ignition key at **MAR**, press and keep button **TRIP** pressed for over 2 seconds to reset.

### Exit Trip

The **TRIP** function is quitted automatically after all values have been displayed or by keeping button **MODE** pressed for over 1 second.

# SEATS

## MANUALLY ADJUSTABLE FRONT SEATS *fig. 27*

### Moving the seat backwards or forwards

Lift the lever **A** (on the internal side of the seat) and push the seat forwards or backwards: in driving position the arms should rest on the rim of the steering wheel.

### Seat height adjustment

Move repeatedly lever **B** upwards or downwards to achieve the required height.

**IMPORTANT** Adjustment must be carried out only seated in the seat.

### Back rest angle adjustment

Turn the knob **C**.

### Lumbar adjustment (where provided)

To adjust, turn the knob **D**.

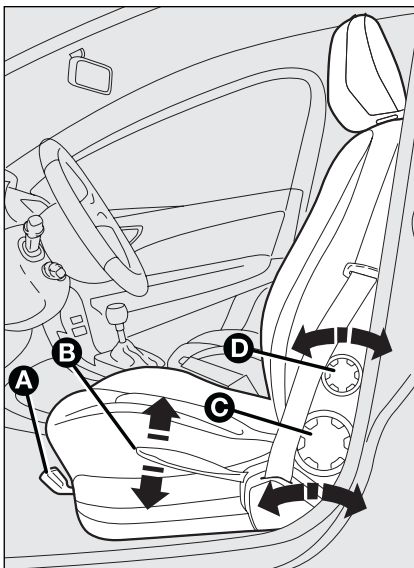

fig. 27

FOQ0654m



**Only make adjustments when the car is stationary.**



**Fabric upholstery of your car is purpose-made to withstand common wear resulting from normal use of the car. It is however absolutely necessary to prevent hard and/or prolonged scratching/scraping caused by clothing accessories like metallic buckles, studs, "Velcro" fixings, etc. that stressing locally the fabric could break yarns and damage the upholstery as a consequence.**



**Once you have released the lever, check that the seat is firmly locked in the runners by trying to move it back and forth. Failure to lock the seat in place could result in the seat moving suddenly and the driver losing control of the car.**

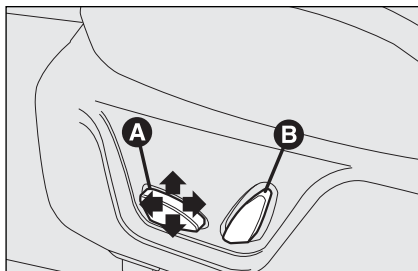

fig. 28

F0Q0601m

## ELECTRICALLY ADJUSTABLE FRONT SEATS (where provided)

### fig. 28

Adjustment is possible when the ignition key is at **MAR** or within 1 minute with ignition key at **STOP** or removed.

When opening one of the front doors, it is possible to adjust the seat on the side of the door opened for about 3 minutes or until closing the door.

Seat adjustment controls are the following:

Multifunction control **A**:

- to adjust height;
- to move seat backwards or forwards.

Multifunction control **B**:

- back rest angle adjustment;
- lumbar adjustment.

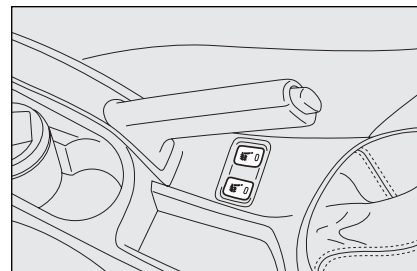



fig. 29

F0Q0013m

## Seat warming (where provided)

### fig. 29

With ignition key at **MAR**, press buttons  to switch the seat warming on/off.

The led on the button will light up when the function is on.

# HEAD RESTRAINTS

## FRONT

Head restraints are adjustable in height and they lock automatically in the required position.

- to raise: raise the head restraint until hearing the locking click.
- to lower: press button **A**-fig. 30 and lower the head restraint.

On some versions, the front head restraints are equipped with an anti-whiplash device, which is able to reduce the distance between the head and head restraint in the case of rear impact, limiting damage caused by whiplash.

If the front head restraint is anti-whiplash type, the head restraint may move if pressure is exercised on the back-rest through the torso or hand. This behaviour is typical of the system and should not be treated as a malfunction.

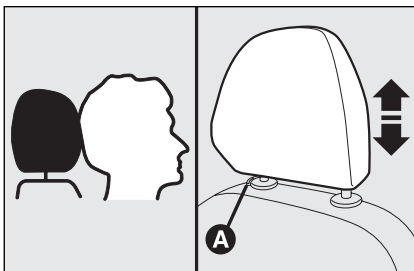

fig. 30

F0Q0655m

**WARNING**

**Remember that the head restraints should be adjusted to support the back of your head and not your neck. Only in this position do they exert their protective action.**

**WARNING**

**To optimise head restraint protective action, adjust the seat back upright and keep your head as close as possible to the head restraint.**

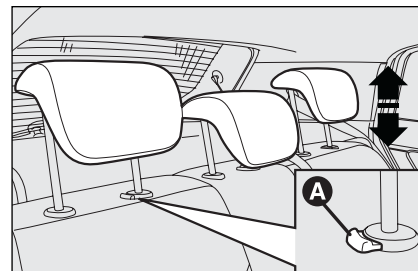

fig. 31

F0Q0656m

## REAR

Car is can be equipped with two head restraints for side seats and, according to versions, also with a third head restraint for the central seat.

To lift out head restraint: take it completely out from the seat back (position of use) until hearing a click.

To bring it back to the original position (non-use position): press button **A**-fig. 31 and lower the head restraint down into its seat.

**IMPORTANT** Rear seat passengers shall always set the head restraints in the position of use.



## STEERING WHEEL

The steering wheel can be adjusted both axially and in height.

Release the lever **A**-fig. 32 pulling it towards the steering wheel, then adjust it in the most suitable position and lock it pushing the lever **A** fully forwards.

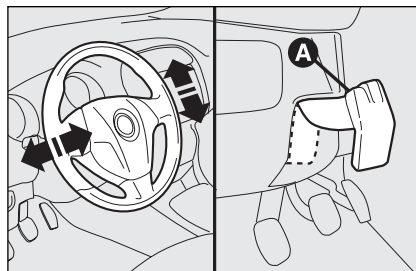

fig. 32

F0Q0657m



### WARNING

*It is absolutely forbidden to carry out whatever after-market operation involving steering system or steering column modifications (e.g.: installation of anti-theft device) that could badly affect performance and safety, cause the lapse of warranty and also result in non-compliance of the car with homologation requirements.*

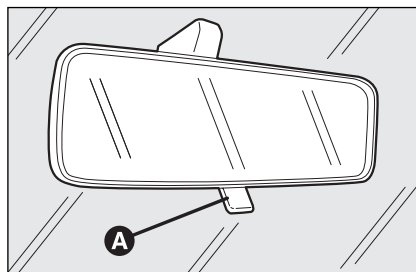

fig. 33

F0Q0659m



### WARNING

*Any adjustment of the steering wheel position must be carried out only with the car stationary and the engine turned off.*

## REARVIEW MIRRORS

### DRIVING MIRROR

The mirror is fitted with a safety device that causes it to be released in the event of a violent crash.

Using lever **A**-fig. 33 the mirror can be adjusted to two different positions: normal or antiglare.

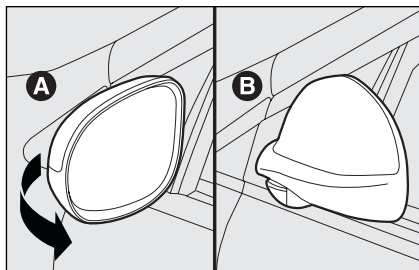

fig. 34

F0Q00658m

## DOOR MIRRORS

### Manual folding

When required (for example when the mirror causes difficulty in narrow spaces) it is possible to fold the mirror moving it from position **A**-fig. 34 to position **B**.



**When driving the mirrors shall always be in position A**-fig. 34.



**As the driver's door mirror is curved, it may slightly alter the perception of distance.**

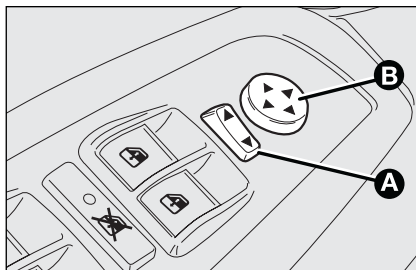

fig. 35

F0Q0623m

### Electrical adjustment

This operation is only possible with ignition key at **MAR**.

Proceed as follows:

- use switch **A**-fig. 35 to select the mirror required (left or right);
- to adjust the mirror move the joystick **B** in the four directions.

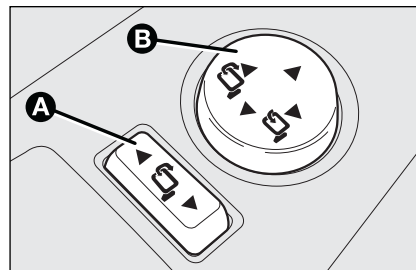

fig. 36

F0Q0425m

### Electric folding (where provided)

This operation is only possible with ignition key at **MAR**.

Proceed as follows:

- set selector **A**-fig. 36 to home position (no mirror selected);
- to fold the mirror move the joystick **B**-fig. 36 in side directions;
- to bring mirrors back to driving position press the joystick **B** again.

# HEATING/CLIMATE CONTROL SYSTEM

F0Q0668m

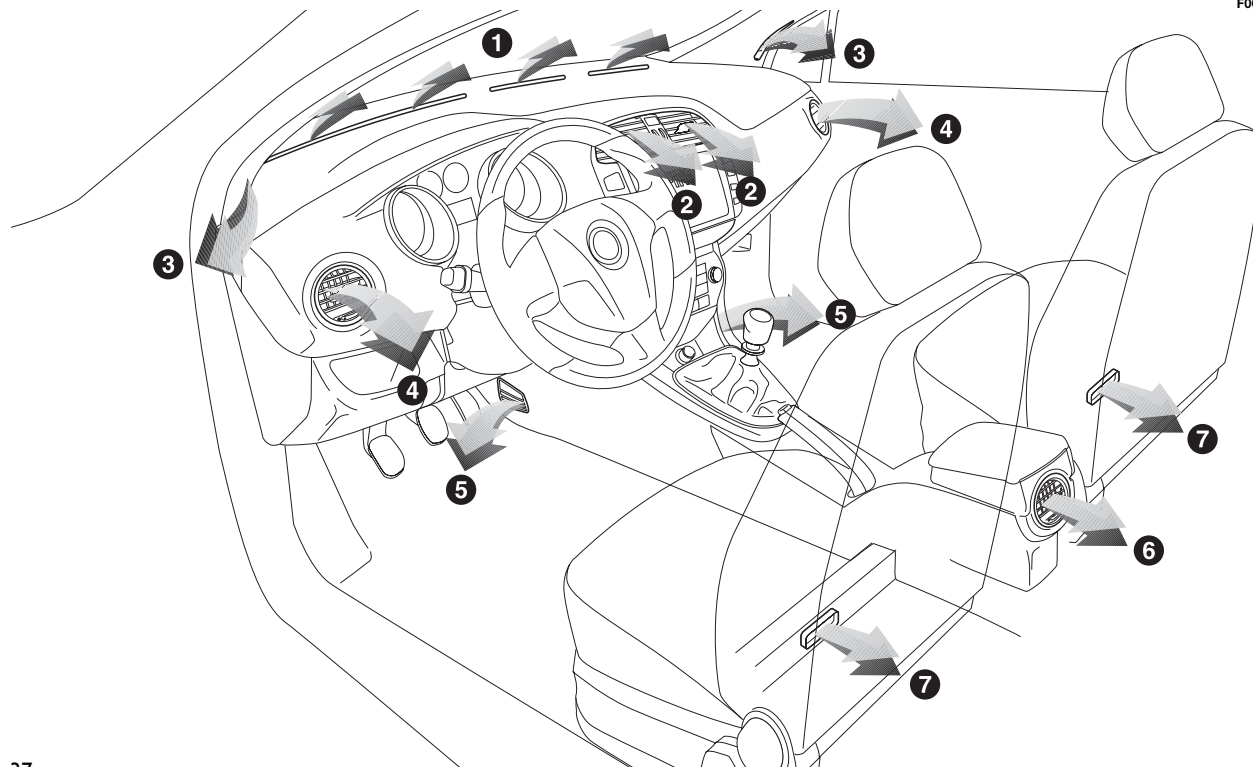

fig. 37

**1.** Upper fixed vent for defrosting or demisting windscreen - **2.** Centre adjustable vent - **3.** Fixed vents for defrosting or demisting side windows - **4.** Side adjustable and swivel vents - **5.** Lower vents - **6.** Rear adjustable and swivel outlet - **7.** Rear feet area fixed vents.

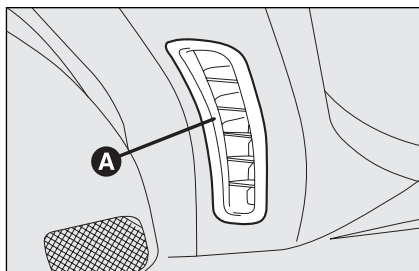

fig. 38

F0Q0626m

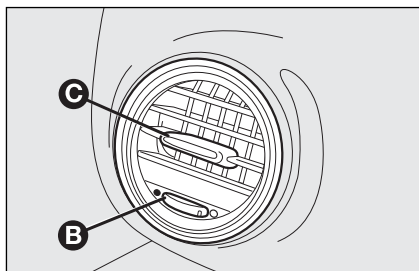

fig. 39

F0Q0625m

### SIDE SWIVEL OUTLETS AND VENTS fig. 38-39

**A** - Fixed vent for side windows.

**B** - Air flow adjusting control:

● = completely closed

○ = completely open.

**C** - Control for directing air flow (up/down, right/left).

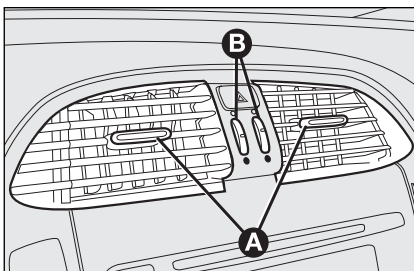

fig. 40

F0Q0627m

### CENTRAL VENTS fig. 40

**A** - Controls for directing air flow (up/down, right/left).

**B** - Air flow adjusting controls:

● = completely closed

○ = completely open.

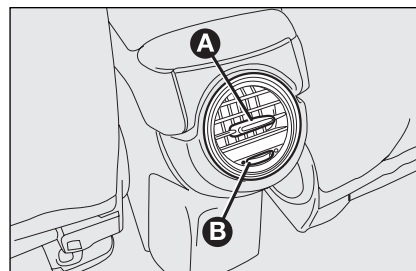

fig. 41

F0Q0750m

### REAR VENT (where provided) fig. 41

**A** - Controls for directing air flow (up/down, right/left).

**B** - Air flow adjusting control:

● = completely closed

○ = completely open.

Certain versions feature an oddment compartment instead of the rear vent.

## HEATING AND VENTILATION

### CONTROLS fig. 42

- A:** Air temperature knob (mixing hot and cold air)
- B:** Heated rear window on/off button
- C:** Fan knob
- D:** Air recirculation on/off button
- E:** Air distribution knob.

### WARMING THE PASSENGER COMPARTMENT

Proceed as follows:

- knob pointer **A** in the red section;
- knob pointer **C** on required speed;
- turn the knob **E** to:
  - ☑️ to warm the feet and at the same time demist the windscreen
  - ☑️ to warm the feet and keep the face cool ("bilevel" function)
  - ☑️ to warm the feet of the passengers in the front and rear seats
- air recirculation off (button led  off).

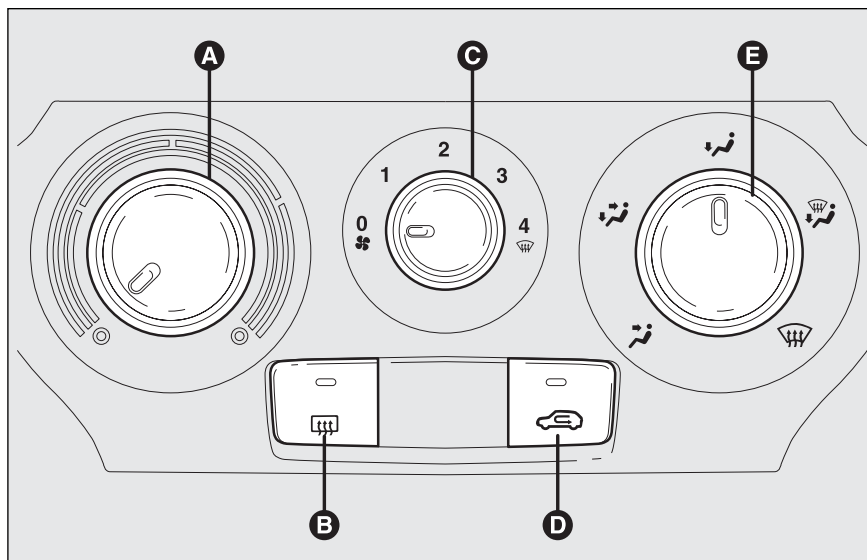





fig. 42

F0Q0609m

### FRONT WINDOW FAST DEMISTING/DEFROSTING



Proceed as follows:

- rotate completely knob **A** to the right;
- turn knob **C** to ;
- turn knob **E** to ;
- air recirculation off (button led  off).



After demisting/defrosting use common controls to maintain the optimum conditions of visibility and comfort.

## Preventive demisting procedure

In the event of considerable outside moisture and/or rain and/or considerable differences in temperature inside and outside the passenger compartment, perform the following preventive demisting procedure:

- air recirculation off (button led  off);
- knob **A** turned to red section;
- turn knob **C** to 2<sup>nd</sup> speed;
- turn knob **E** to  or to  if the windows do not demist.

## HEATED REAR WINDOW AND DOOR MIRROR DEMISTING/DEFROSTING



Pressing button  turns on this function which is shown by the turning on of the led on the button .

This function is timed and switches off automatically after 20 minutes. To cut out this function press again button .

**IMPORTANT** Do not apply stickers on the inside of the rear window over the heating filaments to avoid damage that might cause it to stop working properly.

## FAN SPEED ADJUSTMENT

To ventilate the passenger's compartment properly, proceed as follows:

- Central and side vents: completely open;
- Knob pointer **A** on blue section;
- knob pointer **C** on required speed;
- Knob pointer **E** to .
- air recirculation off (button led  off).

## AIR RECIRCULATION

Pressing button  turns on this function which is shown by the turning on of the led on the button. This function is particularly useful when the outside air is heavily polluted (in a traffic jam, tunnel, etc.). However, it is better not to use it for long periods, especially if there are several people in the car.

**IMPORTANT** The inside air recirculation system makes it possible to reach the required "heating" or "cooling" conditions faster. Do not use the air recirculation function on rainy/cold days as it would considerably increase the possibility of the windows misting inside.

## SUPPLEMENTARY HEATER (where provided)

This device heats up the passenger compartment more rapidly in cold weather conditions with the engine coolant temperature very low.

The additional heater is activated automatically by starting the engine, turning knob **A** to the last red sector and operating the fan (knob **C**) on at least first speed.

The radiator is turned off automatically when conditions of comfort are achieved.

**IMPORTANT** heater activation is prevented if the battery voltage is too low.

## MANUAL CLIMATE CONTROL SYSTEM (where provided)

### CONTROLS fig. 43

- A:** Air temperature knob (mixing hot and cold air)  
**B:** Heated rear window on/off button  
**C:** Fan knob  
**D:** Compressor on/off switch  
**E:** Air recirculation on/off button  
**F:** Air distribution knob.

### WARMING THE PASSENGER COMPARTMENT

Proceed as follows:

- knob pointer **A** in the red section;
- knob pointer **C** on required speed;

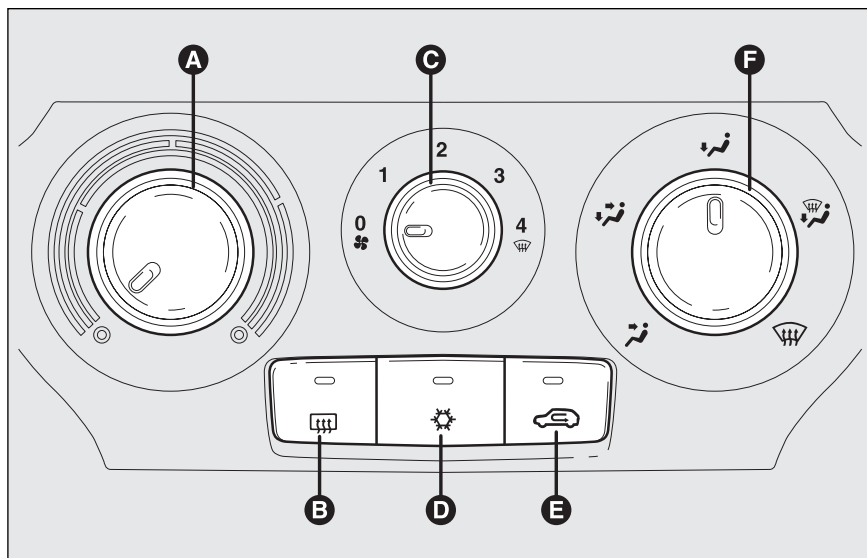







fig. 43

F0Q0610m

- turn knob **F** to:
  - to warm the feet and at the same time demist the windscreen
  - to warm the feet and keep the face cool (“bilevel” function)
  - to warm the feet of the front and rear passengers.
- air recirculation off (button led  off).

## FRONT WINDOW FAST DEMISTING/DEFROSTING





Proceed as follows:

- press button ;
- rotate completely knob **A** to the right;
- turn knob **C** to ;
- turn knob **F** to ;
- air recirculation off (button led  off).

After demisting/defrosting use common controls to maintain the optimum conditions of visibility and comfort.



### Preventive demisting procedure

In the event of considerable outside moisture and/or rain and/or considerable differences in temperature inside and outside the passenger compartment, perform the following preventive demisting procedure:

- press button ;
- air recirculation off (button led  off);
- knob **A** turned to red section;
- turn knob **C** to 2<sup>nd</sup> speed;
- turn knob **F** to  or to  if the windows do not demist.

Climate control system is very useful to speed up demisting since it dehumidifies the air. Set controls to demisting function and switch on the climate control system by pressing button .

## HEATED REAR WINDOW AND DOOR MIRROR DEMISTING/DEFROSTING



Pressing button  turns on this function which is shown by the turning on of the led on the button .

This function is timed and switches off automatically after 20 minutes. To cut out this function press again button .

**IMPORTANT** Do not apply stickers on the inside of the rear window over the heating filaments to avoid damage that might cause it to stop working properly.

## FAN SPEED ADJUSTMENT

To ventilate the passenger's compartment properly, proceed as follows:

- Central and side vents: completely open;
- Knob pointer **A** on blue section;
- knob pointer **C** on required speed;
- Knob pointer **F** to ;
- air recirculation off (button led  off).



## AIR RECIRCULATION



Pressing button  turns on this function which is shown by the turning on of the led on the button.

This function is particularly useful when the outside air is heavily polluted (in a traffic jam, tunnel, etc.) However, it is better not to use it for long periods, especially if there are several people in the car.

**IMPORTANT** The inside air recirculation system makes it possible to reach the required “heating” or “cooling” conditions faster. Do not use the air recirculation function on rainy/cold days as it would considerably increase the possibility of the windows misting inside.

## CLIMATE CONTROL (cooling)

Proceed as follows:

- Knob pointer **A** on blue section;
- knob pointer **C** on required speed;
- Knob pointer **F** to ;
- Press buttons  and  (button leds on).

### Cooling adjustment

Proceed as follows:

- Turn off button  (button led off);
- turn knob **A** to the right to raise temperature;
- Turn knob **C** to the left to reduce the fan speed.

## SUPPLEMENTARY HEATER (where provided)

This device heats up the passenger compartment more rapidly in cold weather conditions with the engine coolant temperature very low.

The additional heater is activated automatically by starting the engine, turning knob **A** to the last red sector and operating the fan (knob **C**) on at least first speed.

The radiator is turned off automatically when conditions of comfort are achieved.

**IMPORTANT** heater activation is prevented if the battery voltage is too low.

### LOOKING AFTER THE SYSTEM

During winter, the climate control system must be turned on at least once a month for about 10 minutes. Before summer, have the system checked at a Fiat Dealership.

# AUTOMATIC TWO-ZONE CLIMATE CONTROL SYSTEM (where provided)

## DESCRIPTION

The car is fitted with a two-zone climate control system which makes it possible to separately adjust the air temperature on the driver's side and on the passenger's side.

The system is fitted with the AQS function (Air Quality System) that turns on inside air recirculation automatically when the antipollution sensor detects the presence of outside polluted air (for example when driving in the city, queues and tunnels).

## CONTROLS fig. 44

- A:** Button for selecting the system automatic mode (AUTO) and knob to adjust temperature on driver side
- B:** Air distribution selection button
- C:** Display showing climate control system data
- D:** Knob for adjusting fan speed

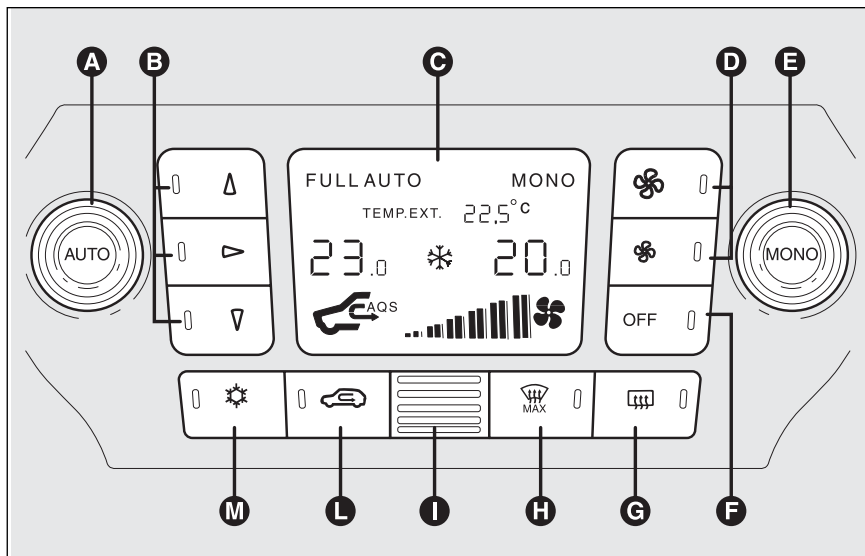

fig. 44

F0Q0611m

- E:** Button for aligning the temperature set on the passenger's side with that on the driver's side (MONO) and knob to adjust temperature on passenger side
- F:** Two-zone climate control on/off button
- G:** Rear window heating on/off button
- H:** MAX-DEF function button (front window fast defrosting/demisting)
- I:** Passenger compartment temperature sensor
- L:** Inside air recirculation and AQS function on/off button
- M:** Climate control compressor on/off button

## SWITCHING THE CLIMATE CONTROL SYSTEM ON

The system can be started by pressing any button, but it is advisable to set the temperatures required on the display; then press button AUTO.

It is possible to personalise required temperatures (driver and passenger) with a maximum difference of 7°C.

The climate control system compressor works only with the engine running and outside temperature over 4°C.

## HOW TO USE THE AUTOMATIC FUNCTION (AUTO)

Press button AUTO; the system will automatically adjust:

- air inlet in the passenger's compartment;
- air distribution in the passenger's compartment;

thus cancelling all the previous manual adjustments.

When the climate control system is working automatically, FULL AUTO is displayed.

It is possible to personalise the choices made automatically by the system intervening manually on the following controls:

- fan speed adjustment knob;
- air distribution selection button;
- inside air recirculation and AQS function on/off button;
- climate control compressor button.



### WARNING

***It is inadvisable to use air recirculation on rainy/cold days as it would considerably increase the possibility of windows misting up inside.***

## FAN SPEED ADJUSTMENT

To adjust the fan speed, press button .

The 12 selectable speeds are shown by the lighting up of the bars on the climate control system display:



- max fan speed = all bars lit
- min fan speed = one bar lit.

The fan can be cut off (all bars off) only if the climate control compressor has been switched off pressing button .

To restore automatic fan speed control, after a manual adjustment, press button AUTO.

## FAST FRONT WINDOW DEMISTING/DEFROSTING (MAX-DEF function)

Pressing button  the climate control automatically activates timed operation of all the functions required to quicken demisting/defrosting of the windscreen and front side windows, i.e.:

- switches on climate control compressor (if outside temperature exceeds 4°C);
- switches off inside air recirculation, if on (button led  off);
- switches on heated rear window (button led  on) and door mirror coils;
- sets max air temperature;
- activates proper air flow.

## HEATED REAR WINDOW AND DOOR MIRROR DEMISTING/DEFROSTING

Pressing button  activates this function. When this function is on, the button led is on.

This function is timed and switches off automatically after 20 minutes. To cut out this function press again button .



**IMPORTANT** Do not apply stickers on the inside of the rear window over the heating filaments to avoid damage that might cause it to stop working properly.



**IMPORTANT** Press button  to obtain outside air inlet into passenger compartment (in this event the button led is off).

## INSIDE AIR RECIRCULATION ON/OFF AND AQS FUNCTION (Air Quality System) BUTTON

Press button .

Inside air recirculation is controlled by three operating logics:

- automatic control, indicated by message AQS on the display and button led  off;
- forced switching off (inside air recirculation always off with air inlet from outside), button led  off;
- forced switching on (inside air recirculation always on with air inlet from outside), button led  on.

Pressing button OFF, the climate control system turns on automatically the inside air recirculation function (button led  on). In these conditions it is however possible to take air from the outside (and vice versa) pressing button  (button led off).

With button OFF pressed (button led on), the AQS (Air Quality System) function cannot be activated.

**IMPORTANT** The inside air recirculation system makes it possible to reach the required “heating” or “cooling” conditions faster. It is however inadvisable to use it on rainy/cold days as it would considerably increase the possibility of the windows misting inside, especially if the climate control system is off. It is advisable to turn on the inside air recirculation system in queues or tunnels to avoid admitting polluted air from outside. The prolonged use of this function should however be avoided, especially with several persons on board, to avoid the possibility of the windows misting inside.

## AQS (Air Quality System) function activation

The AQS function, (message AQS on the display), turns on air recirculation automatically when it detects the presence of outside polluted air (for example when driving in queues and tunnels).

**IMPORTANT** When the AQS function is active, after 15 minutes of consecutive internal air recirculation, the climate control system enables outside air inlet (regardless of air pollution level) for approx. 1 minute to change air inside the passenger compartment.

## ALIGNMENT OF SET TEMPERATURES (MONO function)

Pressing button MONO automatically aligns the temperature on the passenger's side with that on the driver's side.



Turn the knob AUTO or MONO to raise/reduce the temperature between the two zones by the same value.

Press again MONO to disable the function.



## CLIMATE CONTROL COMPRESSOR ON/OFF

Press button  to switch on the climate control compressor.

### Compressor on

- button led  on;
- symbol  on the display, lit.



### Compressor off





- button led  off;
- symbol  on the display, off;
- inside air recirculation off;
- AQS function disabled.

With the climate control compressor off, it is not possible to admit air to the passenger compartment with a temperature below the outside temperature; in this case symbol  flashes on the display.

The switching off of the climate control compressor remains in storage even when the engine has been stopped. To restore automatic control for switching on the climate control compressor, press button  or AUTO, in which case, the other manual settings set will be cancelled.

## AIR DISTRIBUTION SELECTION

Pressing one or more buttons // it is possible to choose manually 7 of the possible air distributions to the passenger compartment:

-  Air flow to the windscreen and front side window vents to demist or defrost them.
-  Air flow towards the front and rear lower parts of the passenger compartment. This type of distribution allows heating of the passenger compartment in the shortest time.
-  Splitting of the air flow between front and rear vents, centre and side dashboard outlets, rear outlet, windscreen and front side window demisting vents.
-  Air flow to the dashboard centre and side outlets (passenger's body).



Splitting of the air flow between feet vents and windscreen and front side window demisting/defrosting vents. This type of air distribution allows satisfactory heating of the passenger compartment while preventing possible misting of the windows.



Splitting of the air flow between feet vents (warmest air) and the dashboard centre and side outlets and the rear outlet (coolest air).



Splitting of the air flow between centre and side dashboard outlets, rear outlet and windscreen and side window demisting/defrosting vents. This type of air distribution allows satisfactory ventilation of the passenger compartment while preventing possible misting of the windows.

**IMPORTANT** For operation of the climate control system, at least one of buttons shall be activated. Deactivation of all buttons is therefore not enabled by the system.

**IMPORTANT** To switch the system on again, press button OFF; this operation resets all operating conditions stored before switching off.

To restore automatic air distribution control after a manual selection, press button AUTO.

### SUPPLEMENTARY HEATER (where provided)

This device heats up the passenger compartment more rapidly in cold weather conditions with the engine coolant temperature very low.

In the above climate conditions, the device comes on automatically when the engine is started with at least one bar of the fan speed indicator lit up.

The radiator is turned off automatically when conditions of comfort are achieved.

**IMPORTANT** heater activation is prevented if the battery voltage is too low.

### SWITCHING THE CLIMATE CONTROL SYSTEM OFF

Press button OFF.

The following information is displayed:

- writing OFF;
- outside temperature;
- inside air recirculation on (button led  on).

## EXTERNAL LIGHTS

The left-hand stalk **fig. 45** controls the external lights.

The external lights can only be switched on when the ignition key is at **MAR**.

### LIGHTS SWITCHED OFF

Knurled ring turned to .

### SIDELIGHTS

Turn the knurled ring to .

The warning light  on the instrument panel will turn on.

### DIPPED BEAM HEADLIGHTS

Turn the knurled ring to .

The warning light  on the instrument panel will turn on.

### MAIN BEAM HEADLIGHTS

When the knurled ring is at  push the lever towards the dashboard (stable position).

The warning light  on the instrument panel will turn on.

To turn the main beams off, pull the stalk towards the steering wheel (dipped beams will turn on again).

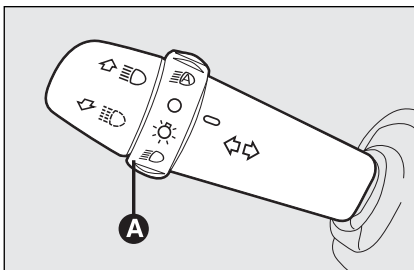





fig. 45

F0Q0649m

### PARKING LIGHTS

These lights can only be turned on with ignition key at **STOP** or removed, by moving the left stalk knurled ring first to  and then to  or .

Warning light  on the instrument panel will turn on. To select the right or left lights use the direction indicator stalk.

### FLASHING THE HEADLIGHTS

Pull the stalk towards the steering wheel (unstable position) regardless of the position of the knurled ring.

The warning light  on the instrument panel will turn on.

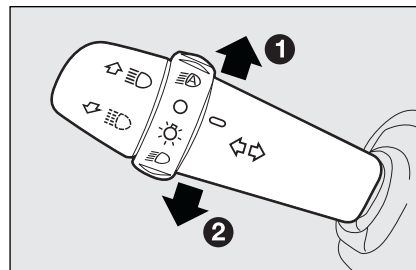

fig. 46



F0Q0650m

### DIRECTION INDICATORS

#### fig. 46

Push the stalk to (stable) position:

- up (position 1): right-hand direction indicator on
- down (position 2): left-hand direction indicator on

Warning light  or  will come on flashing on the instrument cluster at the same time.

Indicators are switched off automatically when the steering wheel is straightened.

#### “Lane change” function

If you want the indicator to flash briefly to show that you are about to change lane, move the left stalk to unstable position for less than one second. The direction indicator of the side selected will flash 3 times and then it will turn off automatically.



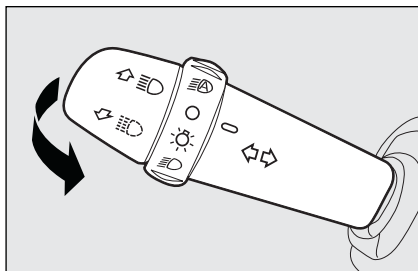

fig. 47

F0Q0651m

### “Cornering lights”

With low beams on at a speed of less than 40 km/h, when the steering wheel is turned through a large angle or upon activation of the direction indicator, a light (incorporated in the fog lamp) will come on to expand the angle of night-time visibility on the side to which the vehicle is turned.

### “FOLLOW ME HOME” DEVICE fig. 47

This function allows the illumination of the space in front of the car for a preset period of time.

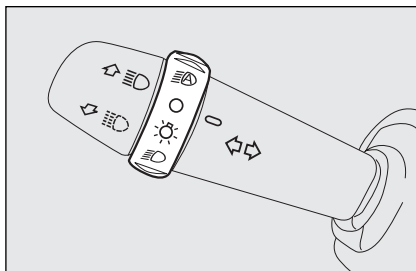

fig. 48

F0Q0652m

### Activation

With the ignition key at **STOP** or removed, pull the stalk towards the steering wheel and operate it within 2 minutes from when the engine is turned off.

At each single movement of the stalk, the staying on of the lights is extended by 30 seconds up to a maximum of 210 seconds; then the lights are switched off automatically.

Each time the lever is operated, the instrument panel warning light  $\text{☞} \text{☞}$  turns on (together with the message on the display) (see section “Warning lights and messages”).

### Deactivation

Keep the stalk pulled towards the steering wheel for more than 2 seconds.

## AUTOMATIC HEADLIGHTS SENSOR (daylight sensor) fig. 48 (where provided)

It detects the changes of the external light intensity of the car according to the light sensitivity set: greater is the sensitivity, smaller is the amount of external light necessary to control the switching-on of the exterior headlights. The daylight sensor sensitivity can be adjusted with the “Set-up Menu” of the instrument panel.

### Activation

Turn the knurled ring to  $\text{☞} \text{☞}$ : in this way, the automatic activation of the side/tail-lights and dipped beam headlights are simultaneously enabled according to the external luminosity.

During the sensor operation lights can only be made flashing.

### Deactivation

As a result of the sensor deactivation, the main beam headlights will switch off and, after about 10 seconds, sidelights will switch off too.

The light sensor is not able to detect the fog presence, lights shall therefore be switched on manually.

# WINDOW WASHING

## WINDSCREEN WASHER/ WIPER fig. 49

The device can only work when the ignition key is at **MAR**.

The stalk can be moved to five different positions:

**A:** windscreen wiper off.

**B:** flick wipe.

With the stalk in position **B**, turning the knurled ring **F** four possible intermittent speeds are obtained:

 = very slow intermittent

 = slow intermittent.

 = intermittent medium.

 = fast intermittent.

**C:** continuous slow;

**D:** continuous fast;

**E:** fast temporary (unstable position).

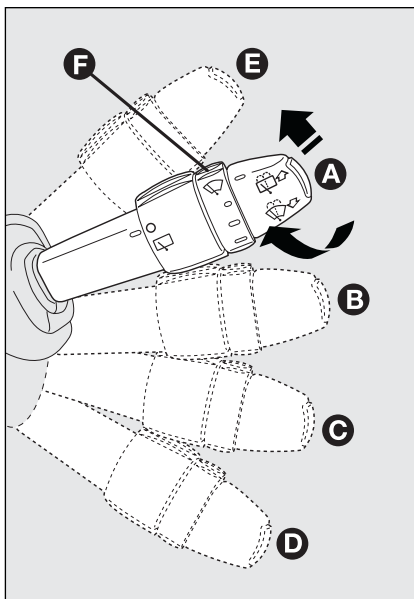

fig. 49

F0Q0645m

Operation in position **E** is limited to the time the lever is held in this position. When the lever is released, it returns to position **A** automatically stopping the wiper.

**IMPORTANT** When the wiper is on, engaging reverse gear automatically turns on the rear window wiper.



**Never use the window wiper to remove ice or snow from the windscreen. In these conditions, the wiper is submitted to excessive effort that results in motor protection cutting in and wiper operation inhibition for few seconds as a consequence. If operation is not restored contact Fiat Dealership.**

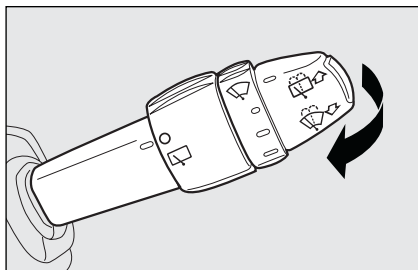

fig. 50

F0Q0646m

### “Smart washing” function fig. 50

Pulling the lever towards the steering wheel (unstable position) operates the windscreen washer.

Keeping the stalk pulled, with just one movement it is possible to operate the washer jet and the wiper at the same time; indeed, the latter comes into action automatically if the stalk is pulled for more than half a second.

The wiper stops working a few strokes after releasing the stalk; a further “cleaning stroke”, after a few seconds, completes the wiping operation.

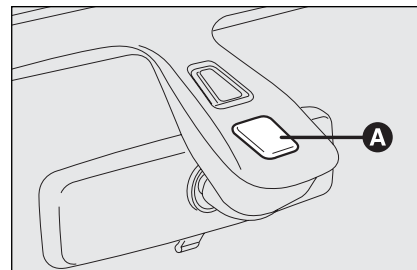

fig. 51

F0Q0014m

### RAIN SENSOR (where provided)

The rain sensor **A-fig. 51** is behind the driving mirror in contact with the windscreen and has the purpose of automatically adjust, during the intermittent operation, the frequency of the windscreen wiper strokes as to the rain intensity.

The sensor has a range of adjustment that gradually varies between wiper stationary (no wiping) when the windscreen is dry, to wiper at first continuous speed (continuous slow) with heavy rain.

## Activation

Move the right-hand stalk downwards by one position.

The activation of the rain sensor is signalled by a control acquisition “stroke”.

**IMPORTANT** Keep clean the glass in the sensor area.

Turning the knurled ring **F-fig. 49** it is possible to increase the sensitivity of the rain sensor, obtaining a quicker change from stationary (no wiping) when the windscreen is dry, to first continuous speed (continuous slow).

The increase of the sensitivity of the rain sensor is signalled by a control and acquisition “stroke”.

Operating the windscreen washer with the rain sensor activated the normal washing cycle is performed at the end of which the rain sensor resumes its normal automatic function.

## Deactivation

Turn the ignition key to **STOP**.

At next engine starting (key at **MAR**), the sensor will not be reactivated even if the stalk is on **B-fig. 49**. In this event, to activate the rain sensor, you have to move the stalk to **A** or **C** and then again to **B**.

When the rain sensor is again activated in this way, at least one windscreen wiper stroke occurs, even if the windscreen is dry.



**Do not activate the rain sensor when washing the car in an automatic washing station.**



**In the event of ice on the windscreen, make sure to have disconnected the device.**



### **WARNING**

**Make sure to have disconnected the device when cleaning the windscreen.**

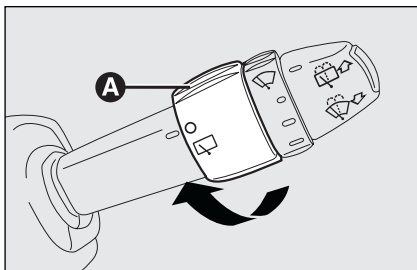



fig. 52

FOQ0653m

### REAR SCREEN WIPER/ REAR SCREEN WASHER fig. 52

This operates only with the ignition turned to **MAR**. Operation ceases when the lever is released.

When the wheel on the lever is turned from position **O** to position , the rear wiper operates as follows:

- in intermittent mode when the rear wiper is not in operation;
- in synchronous mode (at half the rate of the windscreen wiper) when the windscreen wiper is working;
- in continuous mode, with reverse engaged and the control active.

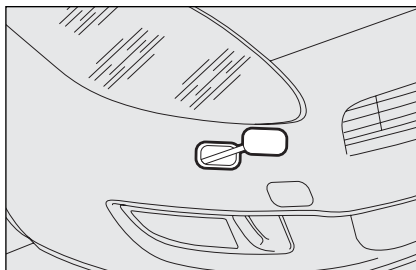

fig. 53

FOQ0018m

### HEADLIGHT WASHER fig. 53

Car headlight washers are “retractable”, i.e.: they are located inside the front bumpers and they are activated (with dipped beam headlights and/or main beam headlights on) when the windscreen washer is operated.

**IMPORTANT** Check at regular intervals correct operation and cleanness of nozzles.

With the windscreen wiper in operation and reverse engaged, continuous operation of the rear screen wiper is also activated. When the lever is pushed toward the dashboard (unstable position), the rear washer jet is also activated. When the lever is held in this position for longer than half a second, the rear wiper is also operated. When the lever is released, smart washing is activated, as for the windscreen wiper.



**Never use the rear window wiper to remove ice or snow from the rear window. In these conditions, the wiper is submitted to excessive effort that results in motor protection cutting in and wiper operation inhibition for few seconds as a consequence. If operation is not restored contact Fiat Dealership.**

## CRUISE CONTROL (constant speed regulator) (where provided)

It is a device able to support the driver, with electronic control, which allows driving at speed over 30 km/h on long and straight dry roads (e.g.: motorways), at a desired speed, without pressing the accelerator pedal.

Therefore it is not suggested to use this device on extra-urban roads with traffic. Do not use it in town.

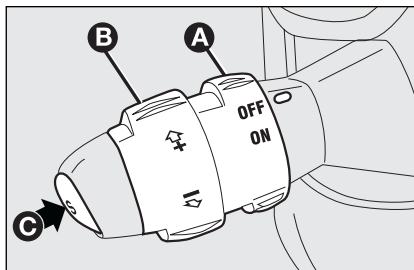



fig. 54

F0Q0648m

### DEVICE ENGAGEMENT

Turn knurled ring **A**-fig. 54 to **ON**.

The device may only be engaged in the 4<sup>th</sup> or 5<sup>th</sup> gear. Travelling downhill with the device engaged, the car speed may increase more than the memorised one.

When the device is activated, the warning light  on the instrument panel turns on (together with the message on the display) (see section “Warning lights and messages”).

### TO MEMORISE SPEED

Proceed as follows:

- turn the knurled ring **A**-fig. 54 to **ON** and press the accelerator pedal to the required speed;
- turn the knurled ring **B** to (+) for at least three seconds, then release it. The car speed is memorised and it is therefore possible to release the accelerator pedal.

In the case of need (when overtaking for instance) acceleration is possible simply pressing the accelerator pedal: releasing the accelerator pedal, the car will return to the speed memorised previously.

## TO RESET THE MEMORISED SPEED

If the device has been disengaged for example pressing the brake or clutch pedal, the memorised speed can be reset as follows:

- accelerate gradually until reaching a speed approaching the one memorised;
- engage the gear selected at the time of speed memorising (4<sup>th</sup> or 5<sup>th</sup> gear);
- press button **C-fig. 54**.

## TO INCREASE THE MEMORISED SPEED

The speed memorised can be increased in two ways:

- pressing the accelerator and then memorising the new speed reached;
- or
- turning the knurled ring **B-fig. 54** temporarily to (+).

Each turn of the knurled ring will correspond to a slight increase in speed (about 1 km/h), while keeping the knurled ring turned will correspond to a continuous speed increase.

## TO REDUCE MEMORISED SPEED

The speed memorised can be increased in two ways:

- disengaging the device and then memorising the new speed;
- or
- keeping the knurled ring **B-fig. 54** to (–) until reaching the new speed which will be memorised automatically.

Each turn of the knurled ring will correspond to a slight reduction in speed (about 1 km/h), while keeping the knurled ring turned will correspond to a continuous speed reduction.

## DEVICE DISENGAGEMENT

Turn the knurled ring **A-fig. 54** to **OFF** or the ignition key to **STOP**. The device is automatically deactivated also in one of the following cases:

- pressing the brake or clutch pedal;
- ASR or ESP cut-in (where provided);



### WARNING

*When travelling with the device on, never set the gearshift lever to neutral.*



### WARNING

*In the event of device malfunction or failure, turn the knurled ring A-fig. 54 to OFF and contact a Fiat Dealership after checking the protection fuse integrity.*

# CEILING LIGHTS

## FRONT CEILING LIGHT WITH SPOT LIGHTS fig. 55

Switch **A** turns on/off the ceiling lights.

With switch **A** in central position, lights **C** and **D** turn on/off when opening/closing the front doors.

With switch **A** pressed on the left side, lights **C** and **D** will always stay off. With switch **A** pressed on the right side, lights **C** and **D** will always stay on.

Light turning on/off is gradual.

Switch **B** performs the spot function; with ceiling light off, it will turn on:

- light **C** if pressed on the left side;
- light **D** if pressed on the right side.

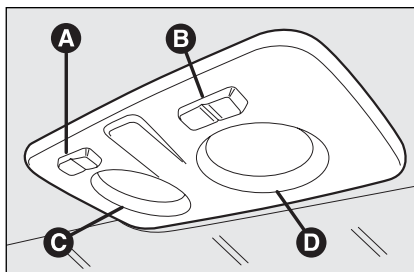

fig. 55

F0Q0669m

**IMPORTANT** Before getting out of the car, make sure the switch is at central position: lights off with doors closed in order to avoid draining the battery. In any case, if the switch is left inadvertently to the On position, the lights will turn off automatically 15 minutes after turning the engine off.

## Ceiling light timing

To facilitate getting in/out of the car at night or with poor lighting, 2 different timed switching on modes have been provided.

### Light timing when getting into the car

Lights will turn on as follows:

- for about 10 seconds when opening front doors;
- for about 3 minutes when opening one of the side doors;
- for about 10 seconds when closing the doors.

Timing will stop when turning the ignition key to **MAR**.



### Light timing when getting out of the car

After removing the key from the ignition switch, the ceiling lights will turn on as follows:

- within 2 minutes from turning the engine off for about 10 seconds;
- when opening one of the side doors for about 3 minutes;
- when closing one of the doors for about 10 seconds.
- when fuel cut-off switch is activated, they stay on for about 15 minutes, and then go off automatically.

Timing will stop automatically when locking the doors (unless the fuel cut-off switch has been activated).

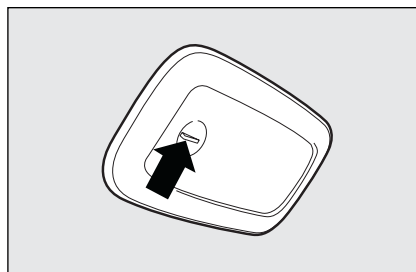

fig. 56

F0Q0670m

## REAR CEILING LIGHT

### Versions without sunroof fig. 56

These versions are equipped with two rear ceiling lights.

To turn these lights on/off press at the point shown by the arrow (mark + on the ceiling light lens).

When the front ceiling light is on, also the rear ceiling lights will come on.

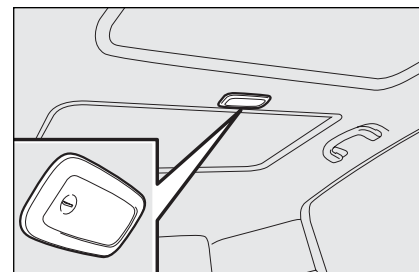

fig. 57

F0Q0740m

### Versions with sunroof fig. 57

These versions are equipped with only one ceiling light.



To turn this light on/off press at the point shown by the arrow (mark + on the ceiling light lens).

When the front ceiling light is on, also the rear ceiling light will come on.

# CONTROLS

## HAZARD LIGHTS

They turn on by pressing switch **A**-fig. 58, regardless of the position of the ignition key.

When the device is on, the switch is flashing and warning lights  and  on the cluster come on.

Press switch **A** again to turn the lights off.

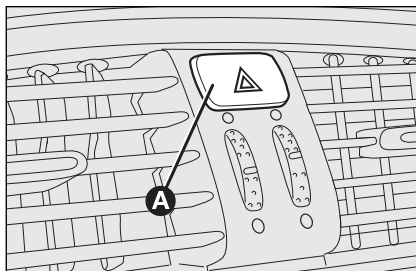

fig. 58

F0Q0637m

## FRONT FOG LIGHTS (where provided)

To turn front fog lights on, press button **B**-fig. 59 to activate these lights it is necessary to have the side/taillights switched on.

Press the button again to turn the lights off.

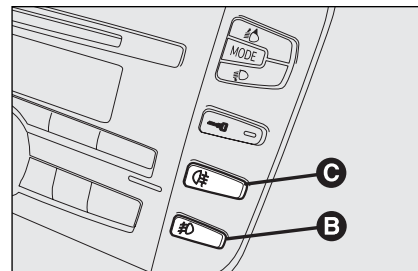

fig. 59

F0Q0636m

## REAR FOG LIGHTS

To turn rear fog lights on, press button **C**-fig. 59, to activate these lights it is necessary to have the dipped beams or front fog lights switched on.

Press the button again to turn the lights off.



### WARNING

*The use of hazard lights is governed by the Highway Code of the country you are in. Keep to the rules.*

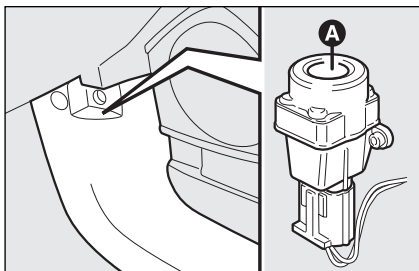



fig. 60

F0Q0638m

### FUEL CUT-OFF SWITCH fig. 60

It is located next to the passenger's door post, at the bottom, and comes into operation in the case of a crash:

- cutting off fuel and switching off the engine;
- automatically unlocking the doors;
- switching on interior lights (for about 15 minutes).

When the switch comes into operation, the instrument panel warning light  or symbol  will turn on (together with the message on the display) (see section "Warning lights and messages").

Carefully inspect the car to find fuel leaks, e.g. in the engine compartment, under the car or near the tank.

If no fuel leaks are found and the car can be started again, press button **A** to reset the fuel system and the lights.

After a crash, remember to turn the ignition key to **STOP** to prevent battery run-down.



### WARNING

*If, after a crash, you smell fuel or see leaks from the fuel system, do not reset the switch to avoid fire risk.*

# INTERIOR FITTINGS

## FRONT ARMREST WITH ODDMENT COMPARTMENT (where provided)

It is located between the front seats. An oddment compartment and a conditioned food box (where provided) are fitted inside the armrest (see next paragraphs).

The armrest can be adjusted longitudinally by operating the cover **A**-fig. 61.

### Oddment compartment

Lift cover **A**-fig. 61 to reach the oddment compartment **B**-fig. 62.



*Pay attention not to spill the drinks: the food box bottom however is provided with a hole to drain spilled liquids, if any.*

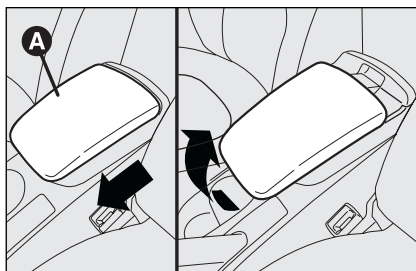

fig. 61

F0Q0631m

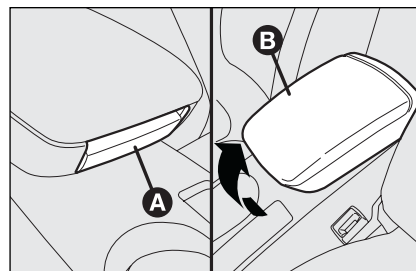

fig. 63

F0Q0634m

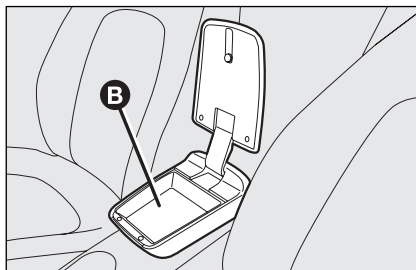

fig. 62

F0Q0632m

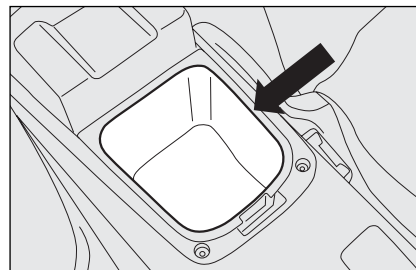

fig. 64

F0Q0633m

### Conditioned food box

Press button **A**-fig. 63 and raise the armrest **B** to reach the conditioned food box fig. 64.

**IMPORTANT** The food box function is to keep the temperature of drinks, that must be warmed or cooled before being fitted inside the food box

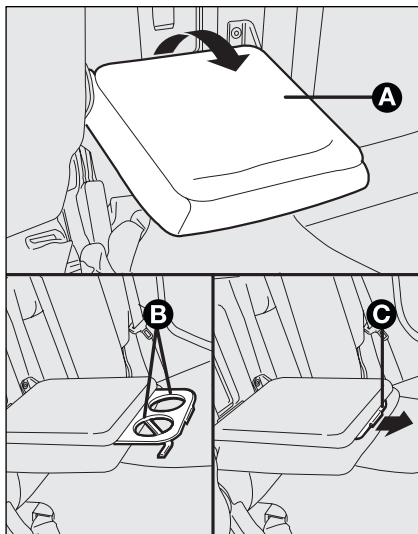

fig. 65

FOQ0010m

## REAR ARMREST (where provided)

To use the rear armrest **A**-fig. 65, lower it as shown in the figure.

The armrest houses two recesses **B** for holding glasses and/or cans. To use them pull the tab **C** in arrow direction.

Inside the armrest, after lifting the cover, there is an oddment compartment.

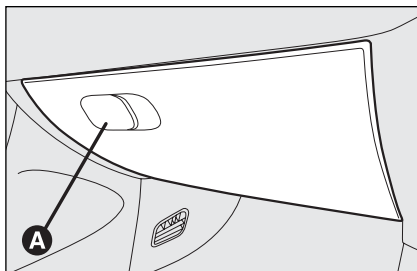

fig. 66

FOQ0635m

## ODDMENT COMPARTMENTS

### Oddment compartment on passenger's side

Open the oddment compartment moving the handle **A**-fig. 66 as shown by the arrow.

When the oddment compartment is opened, an interior courtesy light comes on. Such light stays on for about 15 minutes after having turned the key to **STOP**.

If during this time a door or the boot are opened, the light will come on again for about 15 minutes.



### WARNING

**Never travel with the oddment compartments open to prevent risk of injuries in the event of a crash.**

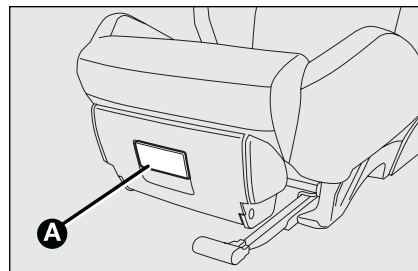

fig. 67

FOQ0012m

### Oddment compartment under driver's seat (where provided) fig. 67

Certain versions are fitted with an oddment compartment under the passenger's seat: only stow objects weighing less than 1.5 kg.

Operate handle **A**-fig. 67 to open the compartment.

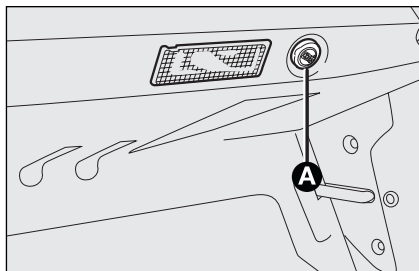

fig. 68

F0Q0016m

### CURRENT OUTLET (12V)

The current outlet is located on the central console and it only works with ignition key at **MAR**. If the smokers' kit is requested, the current outlet will be replaced by the cigar lighter (see next paragraph).

Some versions may also be fitted with a power point **A-fig. 68** located in the luggage compartment.

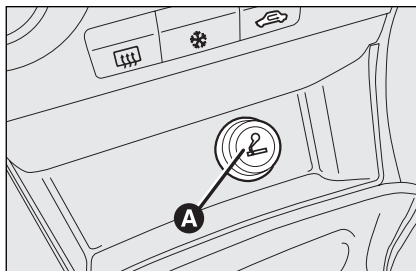

fig. 68/a

F0Q0629m

### CIGAR LIGHTER (where provided)

It is located on the central console, near the handbrake lever.

Press button **A-fig. 68/a** to switch on the cigar lighter with ignition key at **MAR**.

After few seconds the button will return to its initial position and is ready for use.

**IMPORTANT** Always check that the cigar lighter has turned off.

**IMPORTANT** The cigar lighter gets very hot. Handle it with care and make sure that it is not used by children: danger of fire and/or burns.

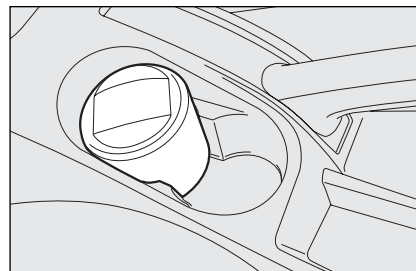

fig. 69

F0Q0630m

### ASHTRAY (where provided)

It consists of a spring-release removable plastic container **fig. 69**, that can be located in the glass/can holder recesses on the central console.

**IMPORTANT** Do not use the ashtray as waste paper basket: it might set on fire in contact with cigarette stubs.

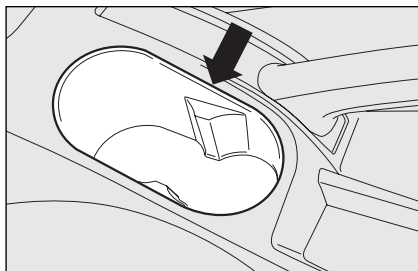

fig. 70

FOQ0671m

### GLASS HOLDERS fig. 70

The central console houses two recesses for glasses, cups or cans.

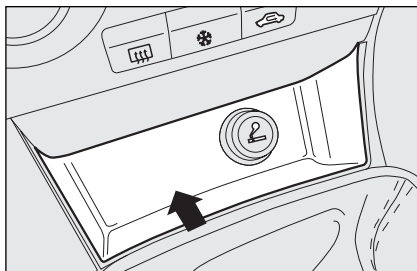

fig. 71

FOQ0672m

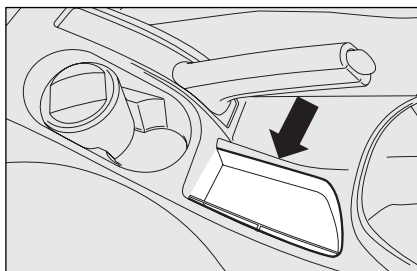

fig. 72

FOQ0673m

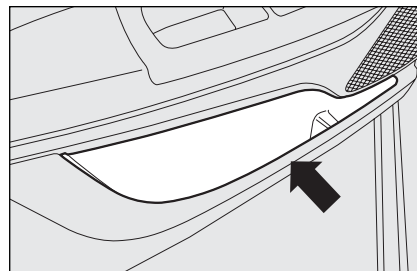

fig. 73

FOQ0674m

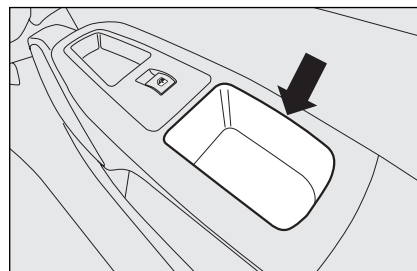

fig. 74

FOQ0676m

### ODDMENT COMPARTMENTS

They are set near the cigar lighter **fig. 71**, near the handbrake **fig. 72**, and front and rear doors **fig. 73** and **fig. 74**.

## SUN VISORS fig. 75

### Driver's side

On certain versions, the driver's sun visor is fitted with a courtesy mirror and a light.

### Passenger's side

The passenger's sun visor is fitted with a courtesy mirror (on certain versions the mirror is fitted with a light).

Driver and passenger's sun visors can be adjusted forwards and sideways.

On certain versions, the passenger's sun visor is fitted, on the back, with a courtesy mirror with a light that enables to use the mirror also with poor sunlight.

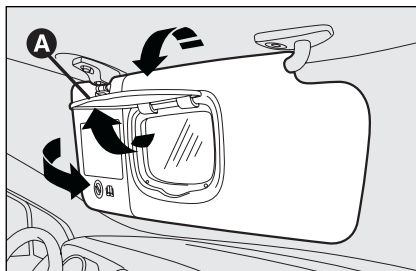

fig. 75

F0Q0675m

Lift the lid **A** to use the mirror.

When the ignition key is at **STOP**, the light stays on for about 15 minutes: if in this period a door or the tailgate is opened, the light will stay on for another 15 minutes.

The passenger's sun visor also carries the symbols and the message concerning the correct use of the child restraint system with passenger's air bag (for further information see paragraph "Passenger's front Air bag" in section "Safety devices").



## SUNROOF (where provided)

The sunroof consists of two wide panes (a fixed one and a moving one), fitted with two manually-operated sun curtains (front and rear).

Sun curtains can be used in “wide close” and “wide open” positions (no fix intermediate positions).

To open sun curtains: take handgrip **A-fig. 76**, release it and guide it in the direction of the arrow to the “wide open” position.

To close them reverse the above procedure. Sunroof only works with ignition key at **MAR**. Controls **A** and **B-fig. 77** set on the special panel near the ceiling light shall be used to open/close the sunroof.

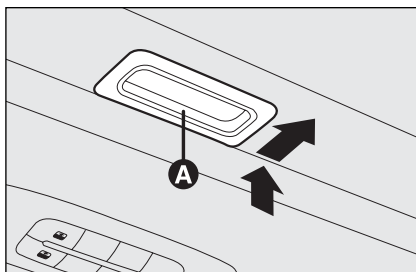

fig. 76

F0Q0737m

### To open

Press button **B-fig. 77** and hold down to move the front glass panel to spoiler position. Press button **B** again and hold down the control for longer than half a second to start the movement of the sun-roof glass, which will continue automatically to an intermediate position (“Comfort” position).

Press the opening control again for longer than half a second and the sun-roof will automatically to the end of its travel. The sun-roof glass may be halted in an intermediate position by operating the button again.

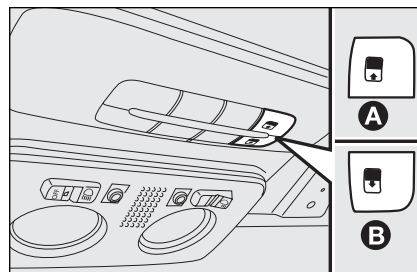

fig. 77

F0Q0678m

### To close

When in fully opened position, press button **A-fig. 77** and if the button is operated for longer than half a second, the roof front glass will automatically move to intermediate position (“Comfort” position).

Operate the button again for longer than half a second and the roof will move to spoiler position. When the closure button is closed again, the sun-roof will move to fully closed position.



Use the sunroof only in “spoiler” position if cross roof rack is fitted.



Do not open the sunroof if there is snow or ice on it: it could be damaged.



### WARNING

When leaving the car, the ignition key should be removed to prevent the sunroof from being operated inadvertently and harming anyone remaining in the car. Improper use of the sunroof can be dangerous. Before and during its operation ensure that any passengers are not at risk from the moving roof either by personal objects getting caught in the mechanism or by being injured by it directly.

## ANTI-CRUSHING SAFETY SYSTEM

Sunroof is fitted with anti-crushing safety system that detects the presence of an obstacle during sunroof closing stroke and that cuts in by stopping and reversing the sunroof stroke.

## INITIALISATION PROCEDURE

Sunroof shall be re-initialised after disconnecting the battery or if the relevant protection fuse is blown.

Proceed as follows:

- Press button **A**-fig. 77 until the roof is fully closed. Release the button;
- press button **A** and hold down for at least 10 seconds and/or until the glass panel is heard to click forward. Now release the button;
- within 5 seconds of carrying out the previous operation, press button **A** and hold down: the glass panel will perform a full opening and closure cycle. Do not release the button until the end of this cycle.

## EMERGENCY OPERATION

If the switch does not work, the sunroof can be operated manually as follows:

- remove the protection cap **A**-fig. 78 set on the rear part of the internal covering;
- take the setscrew wrench provided in the container of the car documents or in the boot (versions with Fix&Go automatic);

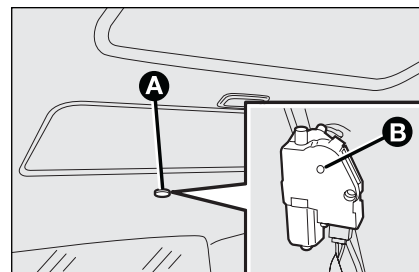

fig. 78

F0Q0738m

- fit the wrench into slot **B** and turn it:
  - clockwise to open the sunroof;
  - counterclockwise to close the sunroof.

# DOORS

## CENTRAL DOOR LOCKING SYSTEM

### From outside

With the doors closed, fit and turn the key in one of the front door locks.

### From inside

From inside the car (with doors closed) press the door lock/unlock button **fig. 79** set on the dashboard.

Doors can however be closed manually if the electric system is failing.

**IMPORTANT** The rear doors cannot be opened from inside when the child lock is engaged.

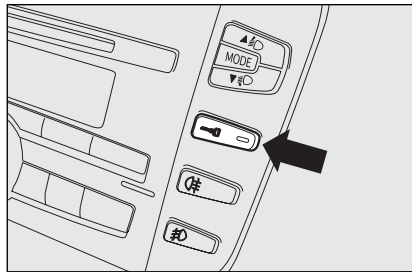

fig. 79

F0Q0641m

### CHILD LOCK **fig. 80**

To prevent opening the rear doors from the inside.

This device can be engaged only with doors open:

- position **1** - engaged (door locked);
- position **2** - disengaged (door can be opened from the passenger's compartment).

The device stays on even if the doors are unlocked by the centralised system.

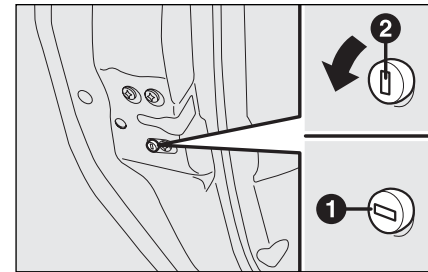

fig. 80

F0Q0677m



**Always use this device when transporting children.**



### **WARNING**

**After engaging the lock on both rear doors, check by trying to open a rear door with the internal handle.**

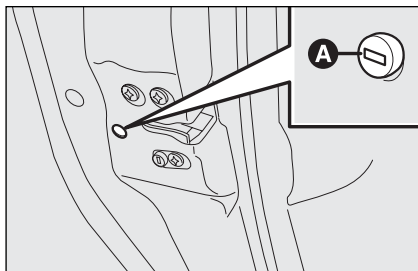

fig. 81

F0Q0679m



## REAR DOORS EMERGENCY LOCK DEVICE fig. 81

Rear doors are fitted with a device enabling to close them also when current is lacking.

In this event proceed as follows:





- fit the metal insert of the ignition key into slot **A**;
- turn the key clockwise and then remove it from slot **A**.

To realign the lock knobs (only if battery charge is restored) proceed as follows:

- press the key button ;
- press door lock/unlock button  on the instrument panel;
- opening with the key in front door revolving plug;
- pulling internal door handle.

**IMPORTANT** If the child lock and the rear door emergency lock are active, operating the internal door handle will not open the door but only realign the lock knobs; to open the door: pull the external handle. Door central locking/unlocking button  will not be disabled when activating the emergency lock.

**IMPORTANT** Door locking/unlocking system shall be re-initialised after disconnecting the battery or if the relevant protection fuse is blown:

- close all the doors;
- press the key button  or door lock/unlock button  on the instrument panel;
- press the key button  or door lock/unlock button  on the instrument panel.



### WARNING

**Do not activate the child lock device and the rear doors emergency lock device at the same time. If both devices are on, to open the door: operate the internal handle to deactivate the rear doors emergency lock device and then open the door using the external handle.**

# POWER WINDOWS

A safety system is provided that is able to detect the present of an obstacle when the window is closing. When this event occurs, the system interrupts and immediately reverses the window travel.

**IMPORTANT** In the event that the anti-crushing function is activated 5 times in only 1 minute, the system will automatically enter the “recovery” mode (self-protection). This conditions is pointed out by the fact that, in the closing phase, the window goes up in jerks.

So, it is necessary to carry out the system restore procedure, acting as follows:

open the windows;

or

turn the ignition key to **STOP** and then to **MAR**.



If no malfunction is present, the window returns to its normal operation automatically.

**IMPORTANT** With ignition key at **STOP** or removed, the power windows remain activated for about 2 minutes and are deactivated immediately the moment a door is opened.



## WARNING

*The system conforms to the forthcoming standard 2000/4/EC concerning the safety of passengers leaning out of the passenger compartment.*

**IMPORTANT** On some versions, when button  on the key with remote control is pressed for longer than 2 seconds, the windows open, while when button  is pressed for longer than 2 seconds, the windows are closed.

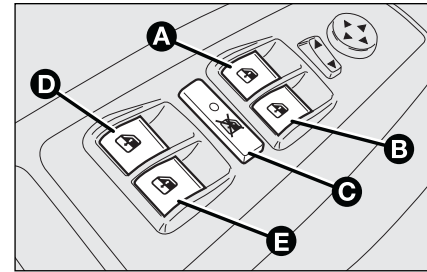

fig. 82

F0Q0622m

## CONTROLS

### Front driver side door fig. 82

On the driver's door panel are set the buttons for controlling, with ignition key at **MAR**:

- A:** front left window opening/closing; window opening or closing in “automatic continuous” mode;
- B:** front right window opening/closing; window opening or closing in “automatic continuous” mode;
- C:** rear power window enabling/disabling controls;

**D:** opening/closure of left front door (where fitted). Continuous automatic operation during window open and closure;

**E:** opening/closure of right front door (where fitted). Continuous automatic operation during window open and closure;

Press buttons **A** or **B** to open/close the required window.

Pressing briefly one of the buttons the window “jerks” whereas a prolonged pressing makes the window opening or closing in “automatic continuous” mode.

Pressing button **A** or **B** again will stop the window in the required position.



## WARNING

*Improper use of the power windows can be dangerous. Before and during its operation ensure that any passengers are not at risk from the moving glass either by personal objects getting caught in the mechanism or by being injured by it directly. Always remove the ignition key when getting out of the car to prevent the power windows being operated accidentally and constituting a danger to the passengers in the car.*

### Passenger side front door/ rear doors

On the passenger side front door panel and on some versions of the rear door, buttons **A**-**fig. 83** are present to control the window.

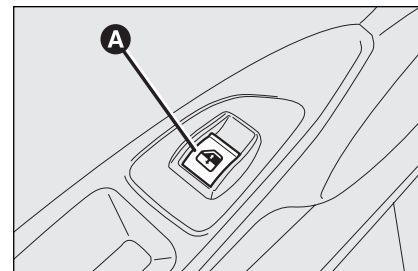

fig. 83

F0Q0743m

### MANUAL REAR WINDOWS (where provided)

Operate the handle to open and close the window.

### Window safety system initialisation

Safety system shall be re-initialised after disconnecting the battery or if the relevant protection fuse is blown.

Initialisation procedure:

- fully close manually the window to initialise;
- after window stopping, keep on pressing the closing control for at least 1 second.

# BOOT

## OPENING THE TAILGATE



### From the vehicle interior (where provided)

On some versions, to open the luggage compartment from inside the vehicle, press the button  **fig. 84**.

### From outside the vehicle

When release, the luggage compartment may be opened from outside the car by operating the electric logo **fig. 85**.

To open the tailgate use the key with remote control.

If the boot is not shut properly the instrument panel warning light  or symbol  will turn on together with the message on the display (see section “Warning lights and messages”).

Opening the boot tailgate, the interior boot ceiling light will come on: the bulb will automatically switch off when closing the boot tailgate.

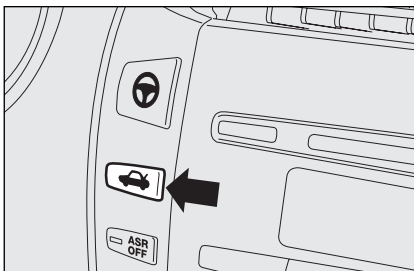

fig. 84

F0Q0036m

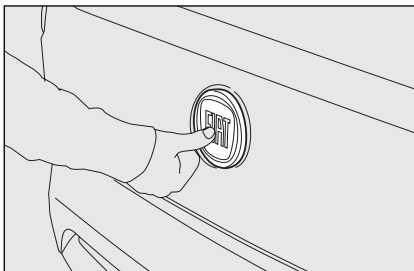



fig. 85

F0Q0680m

Such light will stay on for about 15 minutes after turning the key to **STOP**: if during this time a door or the boot are opened, the light will turn on again for other 15 minutes.

### Opening with the key with remote control

Press button , even when the electronic alarm (where provided) is activated.

Tailgate opening is indicated by double flashing of direction indicators; closing is indicated by one flashing (only if alarm is on).

Opening the tailgate with the alarm on will obtain:

- volumetric protection deactivation;
- anti-raising protection deactivation;
- tailgate monitoring sensor deactivation.

Such control functions are reset when closing the tailgate.

## CLOSING THE TAILGATE

To close, lower the tailgate until the lock clicks.



**The addition of objects (speakers, spoilers, etc.) on the rear shelf or boot lid, except those envisaged by the manufacturer, may prevent the gas filled struts at the sides of the boot from working properly.**



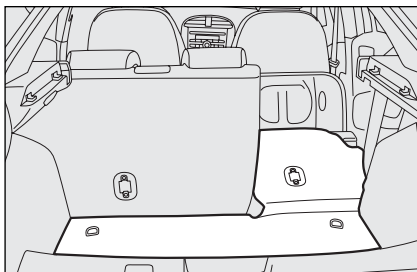

fig. 86

F0Q0681m

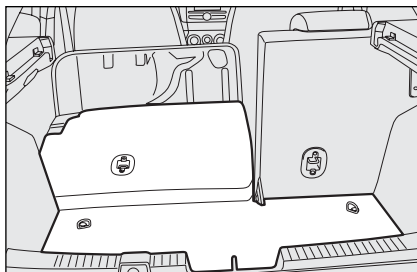

fig. 87

F0Q0682m

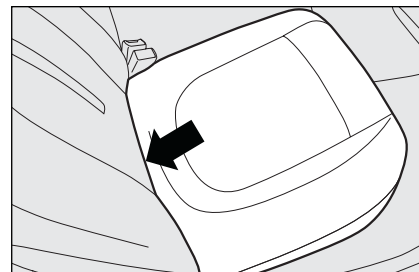

fig. 88

F0Q0684m

**WARNING**

*When using the boot, make sure the loads you are carrying do not exceed the permitted weight (see section “Technical specifications”). Also make sure the items in the boot are arranged properly to prevent them being thrown forwards and injuring passengers should you brake sharply.*

**WARNING**

*Never travel with objects on the rear shelf to prevent them being thrown forwards and injuring passengers in case of accident or sharp braking.*

**EXTENDING THE BOOT**

The boot can be partially (1/3 or 2/3) or totally extended splitting the rear seat.

**Partial extension  
(1/3 or 2/3) fig. 86-87**

The boot extension to the right makes it possible to carry two passengers on the rear seat left-hand side.

The boot extension to the left makes it possible to carry one passenger on the rear seat right-hand side.

Proceed as follows:

- lower completely the rear seat head restraints;
- move the seat belt sideways and check that the belt is not twisted;

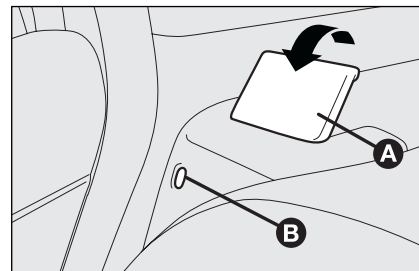

fig. 89

F0Q0683m

- fold the required cushion **fig. 88** forward as shown by the arrow;
- lift seat back retaining lever **A-fig. 89** and tilt the seat back forward. Lever lifting is shown by a “red band” **B**.

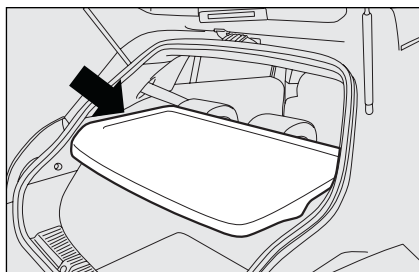

fig. 90

F0Q0686m

### Total extension

Tilt the rear seat completely to obtain maximum boot extension.

Proceed as follows:

- lower completely the rear seat head restraints;
- move the seat belt sideways and check that the belt is not twisted;
- fold cushions forward as described previously;
- remove the rear parcel shelf **fig. 90** and release the upper ends **A-fig. 91** of the two tie rods by removing eyelets from the pins and pushing them in arrow direction;
- after tilting the cushion, fold completely rear seat backs (as described previously) to have one single surface.

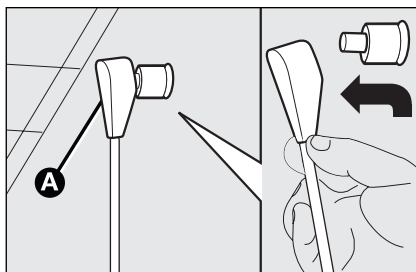

fig. 91

F0Q0687m

### TO RETURN THE REAR SEAT BACK TO ITS ORIGINAL POSITION

Move aside the seat belts, check that they are not twisted.

Lift the seat backs and push them backward until both coupling mechanisms click in place, check that the “red band” **B-fig. 92** at the side of levers **A** is no longer visible.

The “red band” **B** indicates missing seat back coupling.

Reposition the cushions in horizontal position keeping the centre seat belt tongue raised.

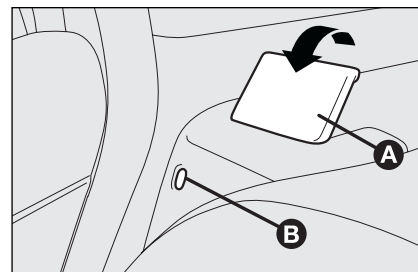

fig. 92

F0Q0683m



### WARNING

*Make sure the seat back is correctly hooked on both sides (“red bands” **B-fig. 92** not visible) to prevent seat back being thrown forwards and injuring passengers should you brake sharply.*

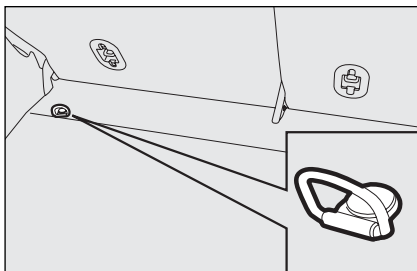

fig. 93

F0Q0688m

## ANCHORING THE LOAD

Two attachments **fig. 93** located inside the luggage compartment are used to anchor cables that insure transported loads are firmly secured and two attachments on the rear crossmember **fig. 94**.

**IMPORTANT** Never anchor to single hooks a load exceeding 100 kg.

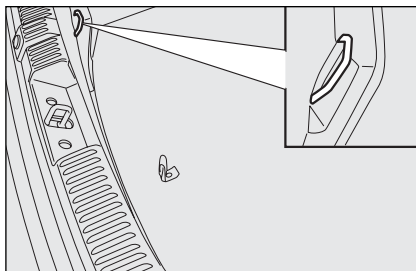

fig. 94

F0Q0688m



### WARNING

***A heavy load that has not been secured may cause serious harm to passengers.***



### WARNING

***If you want to carry reserve fuel in a can, follow law regulations, only using a certified can, suitably fastened to the load securing eyelets. Even in this way the risk of fire is increased in the case of an accident.***

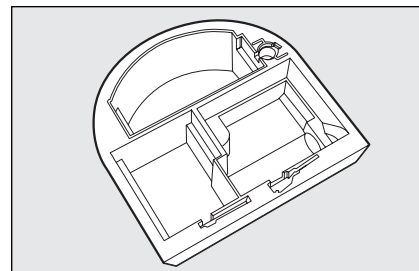

fig. 95

F0Q0002m

## CARGO BOX

This consists of a moulded part **fig. 95**, located in the luggage compartment that may be used to support objects and provide a uniform load compartment level.

# BONNET

## TO OPEN THE BONNET

Proceed as follows:

- pull lever **A-fig. 96** in the direction of the arrow;
- pull lever **B-fig. 97** and raise the bonnet.
- lift the bonnet and at the same time release the rod **C-fig. 98** from the catch, then fit the rod end into the bonnet recess **D**.

**IMPORTANT** Before opening the bonnet, check that windscreen wiper arms are not lifted from the windscreen.

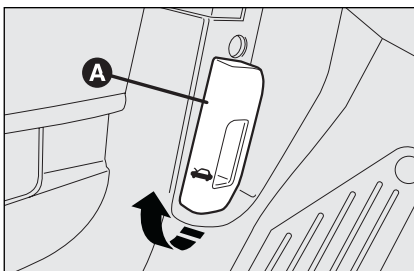

fig. 96

F0Q0689m

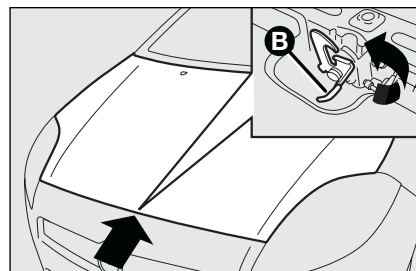



fig. 97

F0Q0690m

## TO CLOSE THE BONNET

Proceed as follows:

- hold the bonnet up with one hand and with the other remove rod **C-fig. 98** from recess **D** and fit it back into its catch;
- lower the bonnet at approx. 20 centimetres from the engine compartment and then let it drop, ensuring that it is fully closed and not just held in position by the safety catch. If the bonnet does not close properly, do not push it down but open it again and repeat the above procedure. If the bonnet is not shut properly, the instrument panel warning light  or symbol  will turn on together with the message on the display (see section “Warning lights and messages”).

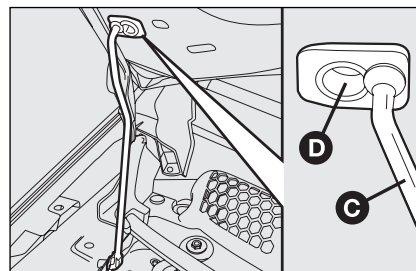

fig. 98

F0Q0748m

**WARNING**

For safety reasons the bonnet must be closed properly to avoid its opening while the car is travelling. Therefore, always check it is properly closed and the catch engaged. Should you notice that the catch is not perfectly engaged when travelling, stop the car immediately and close the bonnet.

**WARNING**

Carry out operations only when the car is stationary.

**WARNING**

If the supporting rod is not positioned correctly the bonnet may fall violently.

**ROOF RACK/SKI RACK**

Front couplings are set at points **A**-fig. 99.

The rear attachments provided are located on points **B**.

A roof rack/ski rack specially designed for the car is available at Lineaccessori Fiat.

**WARNING**

After few kilometres, check that the fastening screws are firmly tightened.



Strictly comply with current law regulations concerning max. overall dimensions.

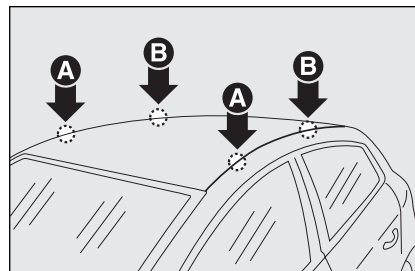

fig. 99

F0Q0692m

**WARNING**

Distribute the load evenly and when driving, bear in mind the increased sensitivity of the car to side wind.



Never exceed the max. permissible loads (see section "Technical specifications").

# HEADLIGHTS

## ADJUSTING THE HEADLIGHT BEAM

Proper adjustment of the headlight beams is of vital importance for your safety and comfort and also for the other road users. To ensure you and other drivers have the best visibility conditions when travelling with the headlights on, the headlights must be set properly. Contact Fiat Dealership to have the headlights properly adjusted.

**IMPORTANT** When turning on gas discharge headlight lamps (where provided), it is normal that there should be a vertical movement of lenses, and consequently the same will also happen to the light beam, for the time required to achieve the correct headlight trim stabilisation, equal to approx. 2 seconds.

## HEADLIGHT AIMING DEVICE

This device can be operated with the ignition key at **MAR** and dipped beams on. When the car is loaded, it slopes backwards. This means that the headlight beam rises. In this case, it is necessary to return it to the correct position.

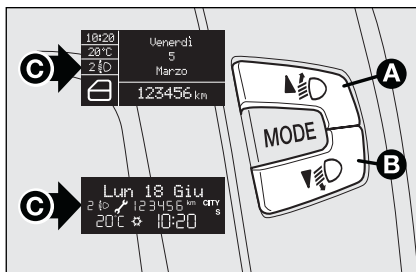

fig. 100

F0Q0644m

## To adjust the headlight slant

Press buttons **A** and **B**-fig. 100 set on the central panel; if the car is fitted with (Xenon) gas discharge headlights, slant adjustment is electronic and therefore buttons **A** and **B** are not present.

Press button **A** this will increase headlight aiming by one position. Press button **B** to decrease headlight aiming by one position.

Displays **C**, located on the instrument panel, provides the visual indication of the positions during the adjustment operation.

## Correct positions as a function of the load

Position **0** - one or two passengers on front seats.

Position **1** - five passengers.

Position **2** - five passengers + load in the boot.

Position **3** - driver + maximum admitted load in the boot.

**IMPORTANT** Check beam aiming every time the load carried changes.

## FOG LIGHT ADJUSTMENT

Contact Fiat Dealership to have the headlights properly adjusted.

## HEADLIGHT BEAM ADJUSTMENT ABROAD

The dipped beam headlights are adjusted for circulation in the country in which the car is marketed. In countries with opposite circulation, to avoid glaring oncoming vehicles, it is necessary to cover the areas of the headlight using a special stick-tape provided for the purpose and available at Lineaccessori Fiat. Contact Fiat Dealership.

## ABS SYSTEM

The car is fitted with ABS braking system, which prevents the wheels from locking when braking, makes the most of road grip and gives the best control when emergency braking under difficult road conditions.

System is completed by EBD (Electronic Braking Force Distribution), which distributes the braking action between front and rear wheels.

**IMPORTANT** To have the maximum efficiency of the braking system, it is necessary a setting period of about 500 km: during this period, it is better to avoid sharp, repeated and prolonged brakes.

## ABS SYSTEM INTERVENTION

The driver can tell the ABS system has come into action because the brake pedal pulsates slightly and the system gets noisier: it means that the car speed should be altered to fit the type of road surface.



### WARNING

*If the ABS system cuts in it is a sign that the grip between the tyre and the road surface has reached the limit you must slow down to match the speed to the road grip available.*



### WARNING

*The ABS exploits the tyre-road grip at the best, but it cannot improve it; you should therefore take every care when driving on slippery surfaces without taking unnecessary risks.*



### WARNING

*When the ABS cuts in, and you feel the brake pedal pulsating, do not remove your foot, but keep it pressed; in doing so you will stop in the shortest amount of space possible under the current road conditions.*

## FAILURE INDICATIONS

### ABS failure



ABS failure is indicated by the turning on of warning light  on the instrument panel (together with the dedicated message on the display) (see section “Warning lights and messages”). In this case the braking system is still efficient, though without the aid of the ABS system. Drive carefully to the closest Fiat Dealership to have the system checked.



#### WARNING

*If the instrument panel warning light  turns on (together with the message on the display), stop the car immediately and contact the nearest Fiat Dealership. Fluid leaks from the hydraulic system, in fact, can compromise the braking system, both traditional systems and systems with ABS.*

### EBD failure

EBD failure is indicated by the turning on of warning lights  and  on the instrument panel (together with the message on the display) (see section “Warning lights and messages”).

In this case with sharp braking the rear wheels might lock too early, with the possibility of skidding. Drive extremely carefully to the nearest Fiat Dealership to have the system checked.

### BRAKE ASSIST (emergency braking assistance) (where provided)

The system, which cannot be cut out, recognizes emergency braking (on the ground of the brake pedal operation speed) and considerably increases the pressure in the braking circuit.

Brake Assist is deactivated on versions equipped with ESP, in the event of ESP system failure (indicated by warning light ) turning on together with the message on the display).



## ESP SYSTEM (Electronic Stability Program) (where provided)

The ESP system is an electronic system controlling the car stability in the event of tyre grip loss.

The ESP system is therefore particularly useful when grip conditions of the road surfaces changes.

With ESP, ASR and Hill Holder systems is also installed (where provided) the MSR system (engine brake torque control system).

### ESP SYSTEM INTERVENTION

It is signalled by the blinking of the warning light  on the instrument panel, to inform the driver that the car is in critical stability and grip conditions.

### ESP SYSTEM ACTIVATION

The ESP system is automatically activated when the car is started and cannot be de-activated.



#### WARNING

**Performance of the ESP system, in terms of active safety should not induce the driver to take pointless and unnecessary risks. The style of driving must in any case always be adapted to the conditions of the road surface, visibility and traffic. Road safety is always the driver's responsibility.**

### FAILURE INDICATIONS

In the event of failure, the ESP system is automatically disconnected and the warning light  comes on with fixed light on the instrument panel (on certain versions together with the message on the display) (see section "Warning lights and messages"). In this case contact a Fiat Dealer as soon as possible.

### HILL HOLDER SYSTEM

This system is an integral part of the ESP system and it is provided to facilitate starting on slopes.

It will activate automatically with the following conditions:

- Uphill: car at a standstill on a road with a gradient higher than 5%, engine running, clutch and brake pedal pressed, gearbox to neutral or engaged gear other than reverse.
- Downhill: car at a standstill on a road with a gradient higher than 5%, engine running, clutch and brake pedal pressed and reverse gear engaged.

At pickup the ESP system control unit will keep brake force on wheels until reaching the torque suitable for starting, or in any case for max. 2 seconds in order to pass easily from the brake pedal to the accelerator pedal.

After two seconds without starting, the system will deactivate automatically by releasing gradually the brake force.

At releasing, the typical brake disengagement noise indicating that the car is going to move will be heard.

## FAILURE INDICATIONS

System failure is indicated by the turning on of warning light  on the instrument panel (together with the message on the display) (see section “Warning lights and messages”).

**IMPORTANT** The Hill Holder system is not a parking brake. Never get out of the car without engaging the handbrake, switching the engine off and engaging the first gear.



### WARNING

*For correct operation of the ESP and ASR systems, the tyres must absolutely be of the same brand and type on all wheels, in perfect conditions and, above all, of type, brand and size specified.*



### WARNING

*During the use of the space-saver spare wheel, the ESP system carries on working. However, you must remind that the space-saver spare wheel has dimensions smaller than the standard tyre and therefore its grip is reduced as to the other car tyres.*

## ASR SYSTEM (Antislip Regulation)

It is an integral part of the ESP system, it controls car drive and cuts in automatically every time one or both driving wheels slip.

According to slipping conditions, two different control systems are activated:

- if the slipping involves both the driving wheels, the ASR function intervenes reducing the power transmitted by the engine;
- if the slipping involves only one driving wheel, the ASR system cuts in automatically braking the wheel that is slipping.

The action of the ASR is particularly helpful in the following circumstances:

- slipping of the inner wheel due to the effect of dynamic load changes or excessive acceleration;
- too much power transmitted to the wheels also in relation to the conditions of the road surface;
- acceleration on slippery, snowy or frozen surfaces;
- in the case of loss of grip on a wet surface (aquaplaning).

## Switching the ASR system on/off

The ASR system switches on automatically each time the engine is started.

Switching on/off is indicated by the relevant message on the display (see section “Warning lights and messages”).



### WARNING

*The performance of the system, in terms of active safety should not induce the driver to take pointless and unnecessary risks. The style of driving must in any case always be adapted to the conditions of the road surface, visibility and traffic. Road safety is always the driver's responsibility.*

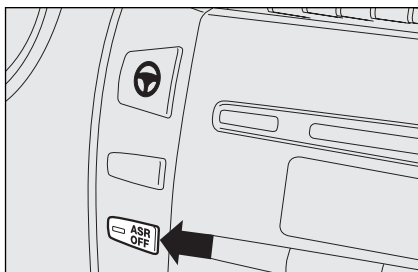

fig. 101

F0Q0694m

When travelling ASR can be switched off and on again by pressing switch ASR OFF set on the dashboard next to the steering wheel **fig. 101**.

When the ASR is switched off this is shown by the lighting up of the led on the switch (and by the relevant message on the display) (see section “Warning lights and messages”).

If the ASR is switched off when travelling, it will turn on again automatically the next time the engine is started.

When travelling on snowy roads with snow chains, it may be helpful to turn the ASR off: in fact, in these conditions, slipping of the driving wheels when moving off makes it possible to obtain better drive.

## FAILURE INDICATIONS

In the event of malfunctioning, the ASR system is automatically disconnected and the warning light  will turn on with fixed light on the instrument panel (together with the message on the display) (see section “Warning lights and messages”). In this case contact Fiat Dealership as soon as possible.



### WARNING

**When using the spare wheel, the ASR system is excluded and the warning light  on the instrument panel turns on glowing steadily (together with the message on the display) (see section “Warning lights and messages”).**



### WARNING

**For correct operation of the ESP and ASR systems, the tyres must absolutely be of the same brand and type on all wheels, in perfect conditions and, above all, of type, brand and size specified.**

### MSR system (engine braking torque control)

The car is fitted with a special system, integral with the ASR system, that in case of sudden gear shifting, cuts in providing torque to the engine thus preventing excessive driving wheel drive that, specially in poor grip conditions, can lead to loss of stability.

## EOBD SYSTEM

The European On Board Diagnostic system (EOBD), fitted to engine electronic control units, allows monitoring and warning of any malfunction to the electronic systems that could increase exhaust emissions.

The objective is:

- To keep system efficiency under control;
- Warn when a fault causes emission levels to increase;
- Warn of the need to replace deteriorated components.

This diagnostic system indicates the presence of deteriorated components or system malfunctioning (see section “Warning lights and messages”) by the turning on of the instrument panel warning light  (together with the message on the display).

**NOTE** The car is provided with a diagnostic connector that can be interfaced with appropriate tools, which makes it possible to read the error codes stored in the control units, together with a series of specific parameters for engine operation and diagnosis. This test can also be performed by traffic controller agents.

**IMPORTANT:** After a servicing operation at Fiat Dealership aimed to eliminate malfunctioning connected to the EOBD system, in order to check the system thoroughly it could be required to run a bench test and, if necessary, road tests which may also call for a long journey.

## SOUND SYSTEM (where provided)

For the operation of the radio with CD/MP3 CD player (where provided), read the instructions for use given in the Supplement attached to this Owner Handbook.

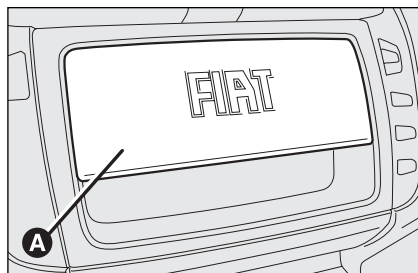

fig. 102

### Sound system installation

The sound system shall be installed in the proper space occupied by the central oddment compartment **A-fig. 102**, here you will find the preset cables.

To remove the oddment compartment press the retaining devices in the points shown in the figure.



### WARNING

*For connection to existing car presetting system, contact Fiat Dealership to prevent any trouble that could impair car safety.*

## INSTALLATION OF ELECTRIC/ELECTRONIC DEVICES

Electric/electronic devices installed after buying the car and in after-market shall bear the following marking:

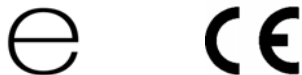

Fiat Auto S.p.A. authorizes the installation of transceivers, provided that installation is workmanlike performed in compliance with Manufacturer's specifications at a specialised service centre.

**IMPORTANT** The installation of devices involving modifications of car characteristics may determine the withdrawal of the driving licence by the appointed public authorities and the forfeiture of the warranty as concerns defects/failures due to said modification or leading directly or indirectly to it.

Fiat Auto S.p.A. declines all responsibility due to damages connected with the installation of accessories/devices not supplied by or recommended by Fiat Auto S.p.A. and installed not in compliance with the specified prescriptions.

## RADIO TRANSMITTERS AND CELLULAR TELEPHONES

Radio transceiver equipment (e.g.: e-tacs mobile phones, HAM radio systems and the like) shall not be used inside the car unless a separate aerial is mounted on the roof.

**IMPORTANT** The use of similar devices inside the passenger compartment (without separated aerial) produces radio-frequency electromagnetic fields which, amplified by the resonance effects inside the passenger compartment, may cause electrical systems equipping the car to malfunction. This could compromise safety in addition to constituting a potential hazard for the passengers.

In addition, transmission and reception of these devices may be affected by the shielding effect of the car body.

As concerns **CE**-approved mobile phones (GSM, GPRS, UMTS), strictly comply with the instructions for use provided by the mobile phone's manufacturer.

## “DUALDRIVE” ELECTRIC POWER STEERING SYSTEM

The car is provided with the electrically controlled power steering system called “Dualdrive” working only with ignition key at **MAR** and engine running, that can be customised by the driver according to the driving conditions.

**IMPORTANT** When turning quickly the ignition key, power steering full operation is obtained after 1-2 seconds.

### ACTIVATION/DEACTIVATION (CITY function) (where provided)

To connect/disconnect the CITY function, press button **A-fig. 103** set on the dashboard next to the steering wheel.

Activation of this function is indicated by the word CITY on the instrument panel display (on certain versions it is also indicated by the turning on of the CITY warning light).

When the CITY function is on the steering wheel effort is lighter and thus parking operations are easier: therefore this function is particularly useful for driving in city centres.

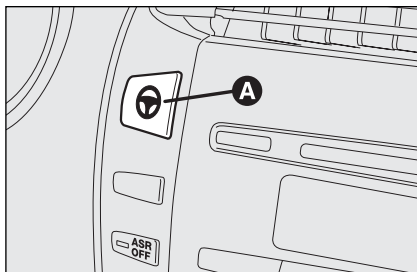

fig. 103

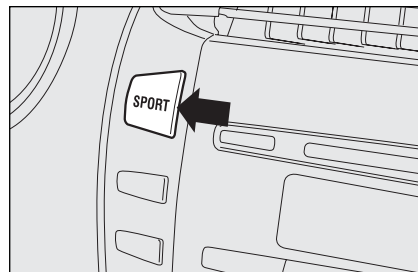



fig. 104

### FAILURE INDICATIONS

Any failure is indicated by the turning on of warning light , together with the message on the display (on certain versions a symbol is displayed) (see section “Warning lights and messages”).

In the event of electric power steering system failure, the car can be driven with mechanical steering.

### SPORT FUNCTION (where provided)

The vehicle may be equipped with a system that allows a choice between two driving modes: normal and sports.

Press the SPORT button **fig. 104** to set the system for a sporty drive with prompter acceleration response and stiffer steering wheel movements for a sportier feel.

Pressing SPORT button enables the over-boost function.

This function enables the engine control unit to reach maximum pressure levels inside the turbocharger, depending on the position of the accelerator pedal and for a limited time. This enables to achieve an increased engine torque.

This function is quite useful if maximum performance is required for a short time (e.g. overcoming other vehicles).

When the function is on, the S symbol is lit on the instrument panel. Press the button again to turn off the function and restore normal steering settings.

**IMPORTANT** when the SPORT button is pressed, the function activates after about 5 seconds.

**IMPORTANT** during acceleration, when the SPORT function is in use, it is possible to feel steering judder, which is typical of this sporty setting.

**IMPORTANT** The steering may become slightly stiff following parking manoeuvres including a great deal of steering. This is normal and caused by a system to prevent motor overheating. No servicing is required. The electric power steering system will return to normal operation the next time the car is used.

## Acceleration

Accelerating violently increasing the revs will greatly affect consumption and emissions: to contain fuel consumption acceleration should be gradual.

Using the SPORT function, fuel consumption will be slightly higher than the values stated in paragraph “Fuel consumption” in this Supplement.



### WARNING

*It is absolutely forbidden to carry out whatever after-market operation involving steering system or steering column modifications (e.g.: installation of anti-theft device) that could badly affect performance and safety, cause the lapse of warranty and also result in non-compliance of the car with homologation requirements.*



### WARNING

*Always switch the engine off, remove the key from the starting device and actuate the steering lock before carrying out any maintenance operation, especially when the wheels are raised from the ground. In case this is not possible (e.g. when the key must be in MAR position or the engine running), remove the electric power steering main fuse before carrying out any maintenance operation.*



## TYRE PRESSURE MONITORING SYSTEM T.P.M.S. (where provided)

The car can be equipped with the T.P.M.S. (Tyre Pressure Monitoring System). This system consists of a radio-frequency sensor, installed on each wheel (on the rim inside the tyre) that sends pressure information to the control unit.



### WARNING

*Pay the utmost attention when checking or inflating tyres. Excessive pressure impairs road holding, increases suspension and wheel stress and causes abnormal tyre wear.*



### WARNING

*Tyre pressure should be checked with tyres rested and cold. Should it become necessary for whatever reason to check pressure with hot tyres, do not reduce pressure although it is higher than the prescribed value but repeat the check when tyres are cold.*



### WARNING

*The T.P.M.S. system does not exempt the driver to check tyre and spare wheel pressure at regular intervals (see paragraph "Wheels" in section "Car maintenance").*

## IMPORTANT NOTES ABOUT THE T.P.M.S. SYSTEM

Failure indications will not be stored and therefore will not be displayed when turning the engine off and on again. If failure persists, the control unit will send warning indications to the instrument panel only after a few seconds when the car is moving.



### WARNING

*T.P.M.S. system cannot indicate sudden tyre pressure drops (e.g.: tyre burst). In this event, brake the car cautiously and avoid sudden steering.*



### WARNING

Replacing standard tyres with winter tyres and vice versa involves T.P.M.S. system set-up that shall be performed at Fiat Dealerships only.



### WARNING

The T.P.M.S. system requires special equipment. Consult Fiat Dealership to know what type of accessories are compatible with the system (wheels, wheel caps, etc.). Using other accessories could cause system malfunctioning.



### WARNING

Tyre pressure could change according to outside temperature. For this reason the T.P.M.S. system could temporarily indicate low tyre pressure. In this event check pressure with cold tyres and restore proper inflation values if required.



### WARNING

If the car is fitted with T.P.M.S. system, when changing a tyre, change also the rubber seal of the valve. Contact a Fiat Dealership.



### WARNING

If the car is fitted with T.P.M.S. system, tyre and/or rim removal and refitting operations involve special precautions; to prevent damages or wrong sensor refitting, contact Fiat Dealership to have tyre and/or rim changed.



### WARNING

Strong radio-frequency noises could inhibit the regular operation of the T.P.M.S. system. This condition will be indicated by the turning on of warning light (⚠) or symbol on the instrument panel, together with the message on the display. Such indication will disappear automatically as soon as radio-frequency noises will stop to disturb the system.

In order to use the system properly, refer to the following table when you have to change wheels/tyres:

Operation	Sensor presence	Failure indication	Fiat Dealership service operation
–	–	YES	Contact Fiat Dealership
Wheel change with spare wheel	NO	YES	Repair damaged wheel
Wheel change with snow tyres	NO	YES	Contact Fiat Dealership
Wheel change with snow tyres	YES	NO	–
Wheel change with others of different size (*)	YES	NO	Contact Fiat Dealership
Wheel cross switching (front/rear) (**)	YES	NO	–

(\*) Given as an alternative on the Owner Handbook and available at Lineaccessori Fiat.

(\*\*) Not cross switched (tyres shall stay on the same side).

## PARKING SENSORS (where provided)

Parking sensors inform the driver about the presence of obstacles behind the car (versions fitted with 4 rear sensors) or behind and in front of the car (versions fitted with 4 rear sensors and 4 front sensors).

This system is therefore an aid for the driver when parking the car since it detects obstacles out of the driver's sight range.

The driver is warned of the presence and distance from the obstacle by an intermittent buzzer (the sound of the buzzer becomes more frequent as the reduction of distance between the car and the obstacle decreases).

### SENSORS

To detect obstacles the system used 4 sensors located on the front bumper (where provided) **fig. 105** and 4 sensors located on the rear bumper **fig. 106**.

### ACTIVATION

#### Version with 4 sensors

In the version with 4 rear sensors, the system turns on automatically when reverse is engaged.

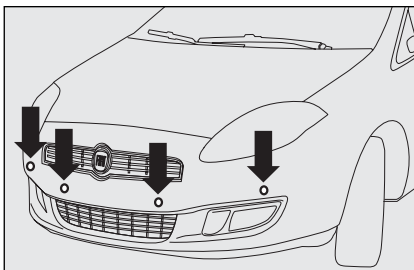

fig. 105

FOQ0745m

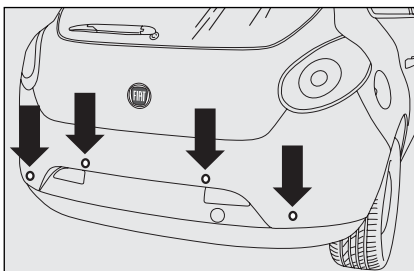



fig. 106

FOQ0603m

#### Version with 8 sensors

In the version with 4 rear sensors and 4 front sensors, the system activates when reverse is engaged or when the button is pressed **P**  **fig. 107**.

When reverse is released, the rear sensors and front sensors remain active until a speed of approximately 15 km/h is exceeded to allow the parking manoeuvre to be completed.

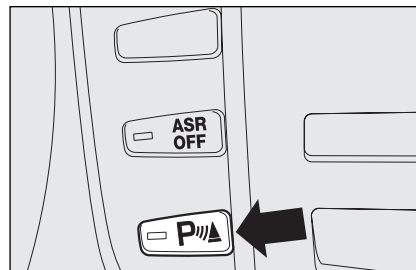



fig. 107

FOQ0035m

The system may be activated by pressing the button **P**  **fig. 107** located on the centre panel: a warning light on the button comes on when the system is active.

The sensors are deactivated by pressing the **P**  **fig. 107** again or exceeding a speed of 15 km/h: the warning light on the button is off when the system is inactive.

When the sensors are activated, the system begins to emit acoustic signals from the front or rear indicators as soon as an obstacle is detected. The frequency arises as soon as the car approaches the obstacle.

When the obstacle is located at a distance of less than 30 cm, the device emits a continuous sound. Depending on the position of the obstacle (in front or behind) the sound is emitted by the corresponding acoustic indicators (front or rear). The obstacle closest to the vehicle is indicated in all cases.

The beep will stop immediately if the distance raises. Beep tone is constant if the distance detected by central sensors is unvaried. If this situation takes place for side sensors, the signal is stopped after about 3 seconds to prevent sound indications when performing manoeuvres near walls.



### WARNING

*Parking manoeuvres however are always under the driver's responsibility that shall always check the absence of people (especially children) or animals in the manoeuvre space. This system is just a help for the driver but she/he shall never reduce attention during dangerous manoeuvres even if performed at low speed.*

## BUZZER WARNINGS

The driver is warned of the presence and distance from the obstacle by the buzzers installed in the passenger compartment:

- in versions with 4 rear sensors, a buzzer located in the front dashboard area warns of the presence of rear obstacles;
- In versions with 8 rear sensors (4 front and 4 rear) a front buzzer warns of the presence of front obstacles and a buzzer at the rear warns of the presence of rear obstacles. This feature gives the driver a sense of directionality (front/rear) about the presence of obstacles.

When the reverse gear is engaged an intermittent acoustic signal is automatically activated.

The acoustic signal:

- becomes louder as the reduction of distance between the car and the obstacle decreases;
- becomes continuous when the distance between the car and the obstacle is less than 30 cm and stops immediately if the distance raises;
- is constant if the distance is unvaried. If this situation takes place for side sensors, the signal is stopped after about 3 seconds to prevent sound indications when performing manoeuvres near walls.



*For proper operation, the parking sensors set on the bumpers shall be clean from mud, dirt, snow or ice. When cleaning the sensors, take the utmost care to prevent their damaging; do not use therefore dry or rough clothes. Sensors shall be washed with clean water and car detergent, if required. In washing stations, clean sensors quickly keeping the vapour jet/high pressure washing nozzles at 10 cm at least from the sensors.*



*Any repainting of bumpers or touch/up in sensor areas shall be carried out at Fiat Dealership only. Improper painting could impair the regular operation of parking sensors.*

## SENSOR DETECTION RANGE

Sensors enable the system to monitor the front part (versions with 8 sensors) and the rear part of the car.

Actually their position covers the central and side areas of the front and rear part of the car.

An obstacle positioned at central area is detected at a distance less than 0.9 m (front) and 1.40 m (rear).

An obstacle positioned at side area is detected at a distance less than 0.6 m.



## OPERATION WITH TRAILER

Parking sensor operation is deactivated automatically when the trailer electric cable plug is fitted into the car tow hook socket.

Sensors are reactivated when removing the trailer cable plug.

**IMPORTANT** If you wish to leave the tow-hook fitted without a trailer attached, contact your Fiat Dealership to update the system because the tow-hook will be detected as an obstacle by the central sensors.

## FAILURE INDICATIONS

In the event of sensor failures, when engaging the reverse gear the driver is warned by the turning on of warning light  on the instrument panel or by symbol , together with the message on the display (see section “Warning lights and messages”).

## GENERAL WARNINGS

When parking, take the utmost care to obstacles set above or under the sensors.

Objects set close to the car front or rear part, under certain circumstances are not detected and could therefore cause damages to the car.

Parking sensors regular operation could be affected by the following conditions:

- Indications sent by the sensors can be altered by dirt, snow or ice deposited on the sensors or by multiple painting.
- Sensors detect non-existing objects, “echo disturbances” due to: car washing, rain (with very strong wind), hail, etc.
- Indications sent by the sensors can also be altered by ultrasound systems (e.g.: truck pneumatic brakes or pneumatic hammers) set nearby the car.

- Parking sensors performance can also be affected by sensor position; for example changes to the car set-up due to shock-absorber wear, suspensions, changing tyres, loading the car too much, implementing special tuning to lower the car.
- Presence of obstacles at the upper side of the car not be detected since the system detects obstacles that could knock into the lower side of the car.

## AT THE FILLING STATION

### PETROL ENGINES

Use only unleaded petrol.

To prevent errors, the diameter of the fuel tank filler is too small to introduce a lead petrol pump filler.

Use petrol with a rated octane number (R.O.N.) not lower than 95.

**IMPORTANT** An inefficient catalyst leads to harmful exhaust emissions, thus contributing to air pollution.

**IMPORTANT** Never use leaded petrol, even in small amount or in an emergency, as this would damage the catalyst beyond repair.

### DIESEL ENGINES

If the outside temperature is very low, the diesel thickens due to the formation of paraffins and could clog the diesel fuel filter.

In order to avoid these problems, different types of diesel are distributed according to the season: summer type, winter type arctic type (mountains/cold areas).

If refuelling with diesel fuel not suitable for the current temperature, mix diesel fuel with TUTELA DIESEL ART additive in the proportions stated on the can, putting first the antifreeze in the tank and then the diesel fuel.

Refuel with local diesel fuel if the car is used/parked in the mountains or in cold areas for a long period. In this event you are recommended to keep an amount of fuel higher than 50% in the tank.



**The car must only be filled with diesel fuel for motor vehicles, in compliance with European Specification EN590.**

***The use of other products or mixtures may irreparably damage the engine with invalidation of the warranty due to the damage caused. In the event of accidentally filling with another type of fuel, do not start the engine and empty the tank. If the engine has been run even for only a very short time, in addition to the tank, it is also necessary to drain out the whole fuel circuit.***

### REFUELLING

To ensure full tank refuelling, carry out two top-up operations once the delivery gun has turned off twice. Avoid further top-up operations which could cause faults in the fuel system.

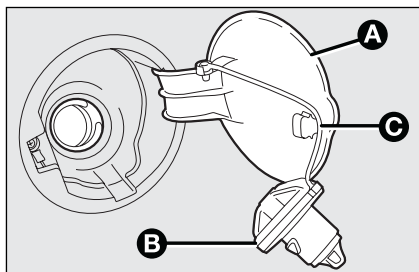

fig. 108

F0Q0695m

### FUEL FILLER CAP fig. 108

To carry out fuelling, open flap **A** and unscrew cap **B**: the cap is fitted with an anti-loss device **C** which fastens it to the flap so it cannot be mislaid.

The cap **B** is fitted with key-lock: open the lid **A**, then, turn the ignition key in the lock and open the cap.

When refuelling, secure the cap to the device inside the lid as shown in the figure.

**IMPORTANT** The sealing of the tank may cause light pressurising in the tank. A little breathing off, while slackening the cap, is absolutely normal.

After refuelling, turn the cap clockwise until it clicks, then turn the key clockwise, remove it and close the flap.



### WARNING

**Keep naked flames or lighted cigarettes away from the fuel filler hole as there is a danger of fire. Do not bend too close to the hole either so as not to breathe in harmful vapours.**

## PROTECTING THE ENVIRONMENT

The devices for curtailing petrol engine emissions are the following:

- three-way catalytic converter;
- Lambda sensor;
- fuel evaporation system.

In addition, do not let the engine run, even for a test, with one or more spark plugs disconnected.

The devices for curtailing diesel fuel engine emissions are the following:

- oxidising catalytic converter;
- exhaust gas recirculation system (E.G.R.);
- Lambda sensors;
- diesel particulate filter (DPF) (where provided it is fitted instead of the Lambda sensor).



## DIESEL PARTICULATE FILTER (DPF) (where provided)

The Diesel Particulate Filter is a mechanical filter, integral with the exhaust system, that physically traps particulate present in the exhaust gases of Diesel engines.

The diesel particular filter has been adopted to eliminate almost totally particulates in compliance with current / future law regulations.

During normal use of the car, the engine control unit records a set of data (e.g.: travel time, type of route, temperatures, etc.) and it will then calculate how much particulates has been trapped by the filter.

Since this filter physically traps particulates, it shall be cleaned (reclaimed) at regular intervals by burning carbon particles. Reclaiming procedure is controlled automatically by the engine control unit according to the filter conditions and the conditions of use of the car.

During reclaiming the following phenomena could take place: idling slight increase, fan activation, slight smoke increase, high exhaust temperatures. These situations shall not be considered as faults and they do not affect car performance and environment.

## Diesel Particulate Filter clogged

If the warning light  on the instrument panel turns on (together with the message on the display) refer to section "Warning lights and messages".



### WARNING

*During normal service the catalyst and the diesel particulate filter (DPF) reach high temperatures. Do not therefore park the car over inflammable materials (grass, dry leaves, pine needles, etc.): fire hazard.*

# SAFETY DEVICES

SEAT BELTS .....	106
S.B.R. SYSTEM .....	108
PRETENSIONERS.....	109
CARRYING CHILDREN SAFELY.....	112
PRESETTING FOR MOUNTING THE ISOFIX CHILD RESTRAINT SYSTEM.....	117
FRONT AIR BAGS .....	120
SIDE AIR BAGS (Side bag - Window bag) .....	123

DASHBOARD  
AND CONTROLS

SAFETY  
DEVICES

CORRECT USE  
OF THE CAR

WARNING  
LIGHTS AND  
MESSAGES

IN AN  
EMERGENCY

CAR  
MAINTENANCE

TECHNICAL  
SPECIFICATIONS

INDEX

## SEAT BELTS

### USING THE SEAT BELTS

The belt should be worn keeping the chest straight and rested against the seat back.

To fasten seat belts, take the tongue **A**-fig. 1 and insert it into the buckle **B**, until hearing the locking click.

At removal, if it jams, let it rewind for a short stretch, then pull it out again without jerking.

To unfasten the seat belts, press button **C**. Guide the seat belt with your hand while it is rewinding, to prevent it from twisting.

Through the reel, the belt automatically adapts to the body of the passenger wearing it, allowing freedom of movement.

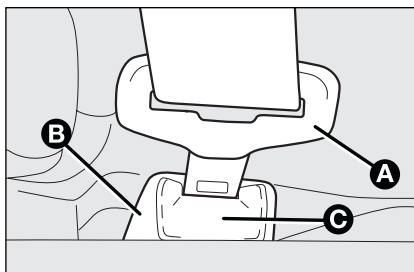

fig. 1

F0Q0696m

When the car is parked on a steep slope the reel mechanism may block; this is normal. The reel mechanism prevents the webbing coming out when it is jerked or if the car brakes sharply, in a collision or when cornering at high speed.

The rear seat is fitted with inertial seat belts with three anchor points and reel for side and central seats.

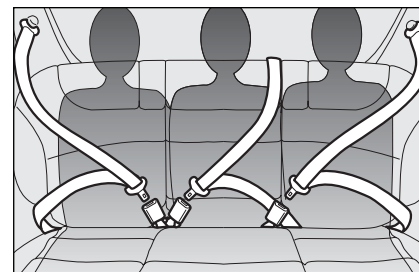

fig. 2

F0Q0267m

Rear seat belts shall be worn as shown in **fig. 2**.



### WARNING

**Never press button C-fig. 1 when travelling.**

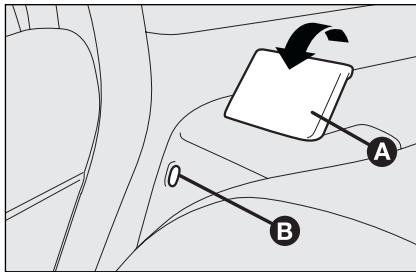

fig. 3

F0Q0683m

**IMPORTANT** When the seat back is coupled properly, the “red band” **B**-fig. 3 present aside lever **A** disappears. The “red band” actually indicates improper seat back coupling.

**IMPORTANT** Remember that in the event of a violent collision, back seat passengers not wearing seat belts also represent a serious danger for the front seat passengers.

**IMPORTANT** After putting the seats back to their travelling position, restore the seat belt position to make them ready for use.



**WARNING**

*Make sure the seat back is correctly hooked on both sides (“red bands” B-fig. 3 not visible) to prevent seat back being thrown forwards and injuring passengers should you brake sharply.*

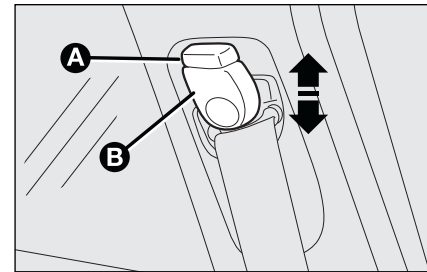

fig. 4

F0Q0697m

**ADJUSTING THE FRONT SEAT BELT HEIGHT**

Four different adjustments in height are provided.

To adjust, press button **A**-fig. 4 and lower or raise the grip **B**.

Always adjust the height of the seat belt to fit the person wearing it. This precaution could greatly reduce the risk of injury in case of collision.

Correct adjustment is obtained when the belt passes half way between the end of the shoulder and the neck.

**WARNING**

*Make the height adjustment when the car is stationary.*

**WARNING**

*After adjustment, always check that the slider is anchored in one of the positions provided. To do this, with the button A-fig. 4 released, exert a further pressure to allow the anchor device to catch if release did not take place at one of the preset position.*

## S.B.R. SYSTEM

The car is fitted with the S.B.R. system (Seat Belt Reminder), consisting of a buzzer which, together with the turning on of warning light  on the instrument panel, warns the driver to fasten the seat belt.

For permanent deactivation, contact Fiat Dealership.

With multifunction display, the S.B.R. system can only be reset at Fiat Dealership.

With reconfigurable multifunction display, the S.B.R. system can also be reset through the set-up menu.

## PRETENSIONERS

To increase the efficiency of the front and rear (where provided) seat belts, the car is fitted with pretensioners. These devices, in the event of violent front and side crash, rewind the seat belts a few centimetres. In this way they ensure that the seat belt adheres perfectly to the wearer before the restraining action begins. The seat belt locks to indicate that the device has intervened; the seat belt cannot be drawn back up even when guiding it manually.

**IMPORTANT** To obtain the highest degree of protection from the action of the pretensioning device, wear the seat belt keeping it firmly close to the chest and pelvis.

Pretensioner activation may produce a small amount of smoke. This smoke is in no way toxic and presents no fire hazard.

The pretensioner does not require any maintenance or greasing. Anything that modifies its original conditions invalidates its efficiency. If due to unusual natural events (floods, seas storm, etc.) the device has been affected by water and mud, it must necessarily be replaced.



### WARNING

***The pretensioner can only be used once. After a collision that has triggered it, have it replaced at a Fiat Dealership. Pretensioner validity is written on the label located inside the lower oddment compartment. Pretensioners should be replaced at Fiat Dealership as this date approaches.***



***Operations which lead to knocks, vibrations or localised heating (over 100°C for a maximum of 6 hours) in the area around the pretensioners may cause damage or trigger them. These devices are not affected by vibrations caused by irregularities of the road surface or low obstacles such as kerbs, etc. Contact a Fiat Dealership for any assistance.***

## LOAD LIMITERS

To increase passenger's safety, the front and rear (where provided) seat belt reels contain a load limiter which allows controlled sag in such a way as to dose the force acting on the shoulders during the belt restraining action in case of front crash.

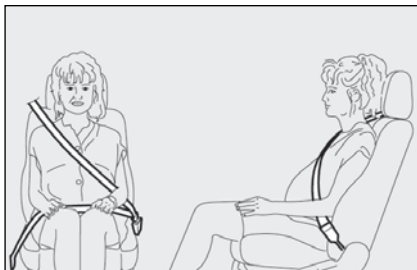

fig. 5

F0Q0015m

## GENERAL INSTRUCTIONS FOR USING THE SEAT BELTS

The driver must comply with (and have the car occupants follow) all the local legal regulations concerning the use of seat belts. Always fasten the seat belts before starting.

Seat belts are also to be worn by expectant mothers: the risk of injury in the case of accident is greatly reduced for them and the unborn child if they are wearing a seat belt. Of course they must position the lower part of the belt very low down so that it passes under the abdomen (as illustrated in **fig. 5**).



fig. 6

F0Q0038m

**IMPORTANT** The belt should not be twisted. The upper part should pass over the shoulder and cross the chest diagonally. The lower part should adhere to the pelvis (as shown in **fig. 6**) and not the abdomen of the passenger. Do not use any objects (pegs, stoppers, etc.) to keep the belts away from the body.



fig. 7

F0Q0039m

**IMPORTANT** Never travel with a child sitting on the passenger's lap with a single belt to protect them both **fig. 7**. Do not fasten other objects to the body.



### WARNING

**For maximum safety, keep the back of your seat upright, lean back into it and make sure the seat belt fits closely across your chest and hips. Make sure that the seat belts of the front and rear passengers are fastened at all times! You increase the risk of serious injury or death in a collision if you travel with the belts unfastened.**



## WARNING

*Under no circumstances should the components of the seat belts and pretensioners be tampered with or removed. Any operation should be carried out by qualified and authorised personnel. Always contact a Fiat Dealership.*



## WARNING

*If the belt has been subjected to heavy stress, for example after an accident, it should be changed completely together with the anchors, anchor fastening screws and the pretensioners. In fact, even if the belt has no visible defects, it could have lost its resilience.*

## HOW TO KEEP THE SEAT BELTS ALWAYS IN EFFICIENT CONDITIONS

Observe the following:

- always use the belt with the tap taut and never twisted; make sure that it is free to run without impediments;
- after a serious accident, replace the belt being worn at that time, even if it does not appear damaged. Always replace the seat belts if pretensioners have been activated;
- to clean the belts, wash by hand with neutral soap, rinse and leave to dry in the shade. Never use strong detergents, bleach or dyes or other chemical substance that might weaken the fibres;

- prevent the reels from getting wet: their correct operation is only guaranteed if water does not get inside;
- replace the seat belt when showing significant wear or cut signs.



## CARRYING CHILDREN SAFELY

For optimal protection in the event of a crash, all passengers must be seated and wearing adequate restraint systems.

This is even more important for children.

This prescription is compulsory in all EC countries according to EC Directive 2003/20/EC.

Compared with adults, their head is proportionally larger and heavier than the rest of the body, while the muscles and bone structure are not completely developed. Therefore, correct restraint systems are necessary, other than adult seat belts.

The results of research on the best child restraint systems are contained in the European Standard EEC-R44. This Standard enforces the use of restraint systems classified in five groups:

Group 0	0-10 kg in weight
Group 0+	0-13 kg in weight
Group 1	9-18 kg in weight
Group 2	15-25 kg in weight
Group 3	22-36 kg in weight

As it may be noted, the groups overlap partly and in fact, in commerce it is possible to find devices that cover more than one weight group.

All restraint devices must bear the certification data, together with the control brand, on a solidly fixed label which must absolutely never be removed.

Over 1.50 m in height, from the point of view of restraint systems, children are considered as adults and wear the seat belts normally.

Lineaccessori Fiat offers seats for each weight group, which are the recommended choice, as they have been designed and experimented specifically for Fiat cars.



### WARNING

*With front passenger's air bag active do not place cradle child's seats facing backwards on the front passenger seat since the air bag activation could cause serious injuries, even mortal regardless of the seriousness of the crash. You are advised to carry children always on the rear seat, as this is the most protected position in the case of a crash.*



### WARNING

***SERIOUS DANGER** Should it be absolutely necessary to carry a child on the front passenger's seat with the cradle seat facing backwards, passenger's air bags (front and side bags, where provided), shall be deactivated through the setup menu. Deactivation shall be checked through the instrument panel warning light . The front passenger's seat shall also be adjusted in the most backward position to prevent any contact between child's seat and dashboard.*





fig. 8

### GROUP 0 and 0+

Babies up to 13 kg must be carried facing backwards on a cradle seat, which, supporting the head, does not induce stress on the neck in the event of sharp deceleration.

The cradle is restrained by the car seat belts, as shown in **fig. 8** and in turn it must restrain the child with its own belts.



fig. 9

### GROUP I

Starting from 9 kg to 18 kg in weight, children may be carried facing forwards, with seat fitted with front cushion, through which the car seat belt restrains both child and seat **fig. 9**.



#### WARNING

*The figure is only an example for mounting. Attain to the instructions for fastening which must be enclosed with the specific child restraining system you are using.*



#### WARNING

*Seats exist which are suitable for covering weight groups 0 and 1 with a rear connection to the car belts and their own belts to restrain the child. Due to their size, they can be dangerous if installed incorrectly fastened to the car belts with a cushion. Carefully follow the instructions for installation provided with the seat.*



fig. 10

F0Q0431m

## GROUP 2

Starting from 15 kg to 25 kg in weight, children may be restrained directly by the car belts **fig. 10**. The only function of the seat is to position the child correctly in relation to the belts, so that the diagonal part adheres to the chest and not to the neck and that the horizontal part clings to the child's pelvis and not the abdomen.



fig. 11

F0Q0432m

## GROUP 3

For children from 22 kg to 36 kg the size of the child's chest no longer requires a support to space the child's back from the seat back.

**Fig. 11** shows proper child seat positioning on the rear seat.

Children taller than 1.50 m can wear seat belts like adults.



## WARNING

*The illustrations are indicative only for assembly. Assemble the seat according to the compulsory instructions provided with it.*

## PASSENGER SEAT COMPLIANCE WITH REGULATIONS ON CHILD'S SEAT USE

Your car complies with the new European Directive 2000/3/EC regulating child's seat assembling on the different car seats according to the following table:

Group	Range of weight	Front passenger	Rear passenger	Central rear passenger
Group 0, 0+	up to 13 kg	U	U	U
Group 1	9-18 kg	U	U	U
Group 2	15-25 kg	U	U	U
Gruppo 3	22-36 kg	U	U	U

### Key:

U = suitable for child restraint systems of the "Universal" category, according to European Standard EEC-R44 for the specified "Groups".

**Below is a summary of the rules of safety to be followed for carrying children:**

- 1) The recommended position for installing child's seat is on the rear seat, as it is the most protected in the case of a crash.
- 2) If the passenger airbag is deactivated, always check that it is properly deactivated by ensuring the warning light  is on with a fixed light on the instrument panel.
- 3) Attain to the instructions for fastening the specific child restraint system which you are using. These instructions must be provided by the manufacturer. Keep the child restraint system installation instructions with the car documents and this Handbook. Never use a child restraint system without installation instructions.

- 4) Always check the seat belt is well fastened by pulling the webbing.
- 5) Only one child is to be strapped to each retaining system.
- 6) Always check the seat belts do not fit around the child's throat.
- 7) While travelling, do not let the child sit incorrectly or release the belts.
- 8) Passengers should never carry children on their laps. No-one, however strong they are, can hold a child in the event of a crash.
- 9) In case of an accident, replace the child's seat with a new one.

**WARNING**

*With passenger's air bag active, never place child's seats with the cradle facing backwards since the air bag activation could cause to the child serious injuries, even mortal, regardless of the seriousness of the crash that triggered it. You are advised to carry children always with proper restraint systems on the rear seats, as this is the most protected position in the case of a crash.*

## PRESETTING FOR MOUNTING THE ISOFIX CHILD RESTRAINT SYSTEM

This car is preset for mounting the Universal Isofix child restraint system, a new European standardised system for carrying children safely.

It is possible to mount at the same time both the traditional restraint system and the Isofix one.

**Fig. 12** shows a child's seat by way of example. The Universal Isofix child's seat covers weight group: I.

Other weight groups are covered by a specific Isofix child seat that can be used only if specifically designed, tested and approved for his vehicle (see the list of vehicles accompanying the child seat).

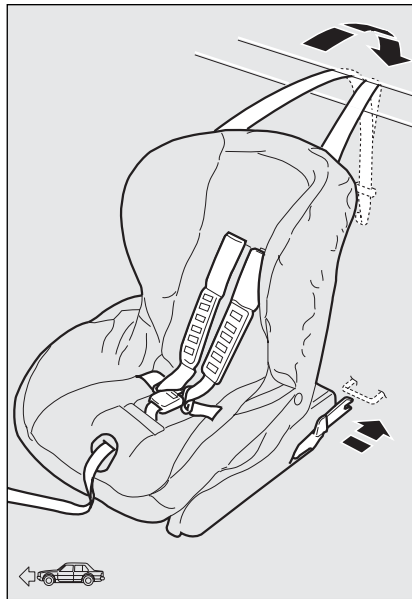

fig. 12

Due to its different anchoring system, the Universal Isofix child's seat shall be anchored to the proper lower metal rings **A**-**fig. 13**, set between rear seat back and cushion. The upper belt (provided with the child's seat) shall be then secured to ring **B**-**fig. 14** set at the back of the seat backrest at child's seat height.

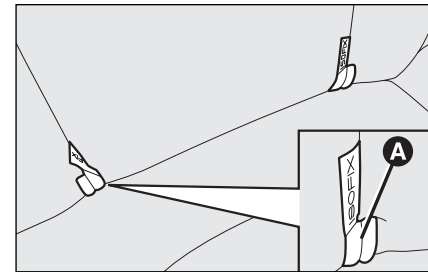

fig. 13

Remember that in case of Universal Isofix child's seat, you can only use all those seats approved with the marking ECE R44/03 Isofix.

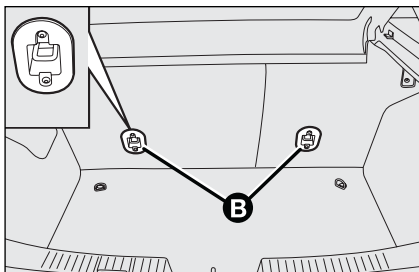

fig. 14

FOQ0699m

At Lineaccessori Fiat is available the “Duo Plus” Universal Isofix child’s seat .

For any further installation/use detail, refer to the “Instructions Manual” that must be provided by the child’s restraints system Manufacturer.

**WARNING**

*Mount the child restraint system only with the car stationary. The Isofix child restraint system is properly anchored to the mounting brackets when clicks are heard. In any case, keep to the installation instructions that must be provided by the child restraint system Manufacturer.*

## PASSENGER SEAT COMPLIANCE WITH REGULATIONS ON UNIVERSAL ISOFIX CHILD'S SEAT USE

The table below, according to ECE 16 European Directive, shows the different installation possibilities of Universal Isofix restraint systems on seats fitted with Isofix fasteners.

Range of weight	Child's seat orientation	Isofix class	Isofix position side rear
Group 0 to 10 kg	Facing backwards	E	IL
	Facing backwards	E	IL
Group 0+ to 13 kg	Facing backwards	D	IL
	Facing backwards	C	IL (*)
	Facing backwards	D	IL
	Facing backwards	C	IL (*)
	Facing forwards	B	IUF
Group I - 9 to 18 kg	Facing forwards	BI	IUF
	Facing forwards	A	IUF

IUF: suitable for Isofix child restraint systems to be set facing forwards, universal class (fitted with third upper fastener), approved for the weight group.

IL: suitable for Isofix TYPE child restraint systems, specific and approved for this type of car. The child's seat can be installed by moving forward the front seat.

(\*) The Isofix child seat can be mounted by positioning the front seat at its full height.



## FRONT AIR BAGS

The car is fitted with front air bags for the driver, for the passenger and with driver's knees air bag (where provided).

The front air bags (driver and passenger) and driver's knees air bag (where provided) have been designed to protect the occupants in the event of head-on crashes of medium-high severity, by placing the cushion between the occupant and the steering wheel or dashboard.

Front air bags are designed to protect car's occupants in front crashes and therefore non-activation in other types of collisions (side collisions, rear shunts, roll-overs, etc.) is not a system malfunction.

In case of front crash, an electronic control unit, when required, triggers the inflation of the cushion according to the severity of the collision. The cushion immediately inflates, placing itself as a protection between the body of the front occupants and the structure that could cause injuries. Immediately after, the cushion deflates.

The front driver / passenger air bags and the driver's knees air bag (where provided) are not a replacement of but complementary to the use of belts, which should always be worn, as specified by law in Europe and most non European countries.

In case of crash, a person not wearing the seat belt moves forward and may come into contact with the cushion while it is still inflating. Under this circumstance the protection offered by the air bag is reduced.

Front air bag may not be activated in the following situations:

- front collisions against highly deformable objects not affecting the car front surface (e.g. bumper collision against guard rail, etc.);
- in case of wedging under other vehicles or protective barriers (for example under a truck or guard rail);

as it offers no additional protection compared with the seat belts, consequently, it would be pointless. Therefore, failure to come into action in the above circumstances does not mean that the system is not working properly.



### WARNING

**Do not apply stickers or other objects to the steering wheel or to the air bag cover on the passenger's side or on the side roof lining. Do not put objects on the dashboard on passenger side since they could interfere with proper passenger air bag inflation and cause injuries to the car's passengers.**

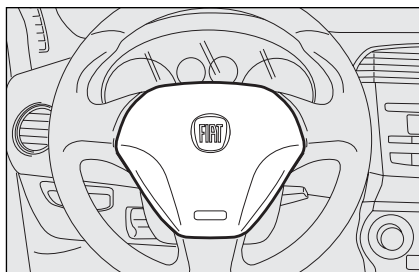

fig. 15

F0Q0624m

### DRIVER'S FRONT AIR BAG fig. 15

It consists of an instant-inflating cushion contained in a special recess in the centre of the steering wheel.



#### WARNING

***Always keep your hands on the steering wheel rim when driving, so that if the air bag is triggered, it can inflate without meeting any obstacles which could cause serious harm to you. Do not drive with the body bent forwards, keep the seat back rest in the erect position and lean your back well against it.***

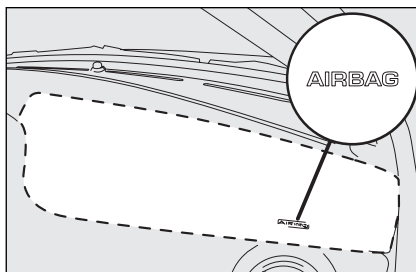

fig. 16

F0Q0700m

### PASSENGER'S FRONT AIR BAG fig. 16

It consists of an instant-inflating cushion contained into a special recess in the dashboard, this cushion has a volume bigger than that of the driver.

The driver's and passenger's front Air bags have been designed and calibrated to improve the protection of a person wearing seat belts.

At their maximum inflation, their volume fills most of the space between the dashboard and the passenger.



#### WARNING

***SERIOUS DANGER: With passenger's air bag active, never place child's seats with the cradle facing backwards since the air bag activation could cause to the child serious injuries, even mortal. In the case of need, always deactivate the passenger's air bag when a child's seat is placed on the front seat. The front passenger's seat shall be adjusted in the most backward position to prevent any contact between child's seat and dashboard. Even if not compulsory by law, you are recommended to reactivate the air bag immediately as soon as child transport is no longer necessary.***



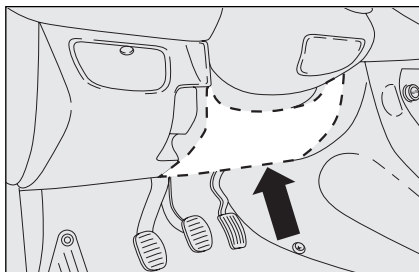

fig. 17

F0Q0702m

### DRIVER'S KNEES AIR BAG fig. 17 (where provided)

Knees air bag consists of an instant-inflating cushion housed into a special compartment provided for the purpose under the steering wheel at driver's knees level, designed to give further protection in the event of frontal crash.

### MANUAL DEACTIVATION OF PASSENGER'S FRONT AIR BAG AND SIDE BAG (where provided)

Should it be absolutely necessary to carry a child on the front seat, the passenger's front air bag and the side bag (where provided) can be deactivated.

The instrument panel warning light  will stay on glowing steadily until reactivating passenger's air bag.



#### WARNING

To deactivate the passenger's front air bag and the side bag (where provided), refer to paragraphs "Multifunction display" and "Reconfigurable multifunction display" in section "Dashboard and controls".

## SIDE AIR BAGS (Side bag - Window bag)

The car is fitted with front side bags for driver and passenger (where provided) for protecting the chest and window bags (where provided) for protecting front and rear passengers' head.

Side bags protect car occupants from side crashes of medium-high severity, by placing the cushion between the occupant and the internal parts of the side structure of the car.

Non-activation of side bags in other types of collisions (front collisions, rear shunts, roll-overs, etc...) is not a system malfunction.

In case of side crash, an electronic control unit, when required triggers the inflation of the cushion. The cushion immediately inflates, placing itself as a protection, between the occupant's body and the structure that could cause injuries. Immediately after, the cushion deflates.

Side bags are not a replacement of but complementary to the belts, which you are recommended to always wear, as specified by law in Europe and most non-European countries.

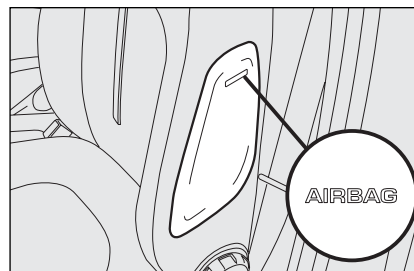

fig. 18

F0Q0701m

### SIDE BAGS (where provided)

They consist of two types of instant inflation cushions and are housed in the back rests of the front seats **fig. 18**. The task of the side air bags is to increase protection of the occupants' chest in the event of a side crash of medium-high severity.

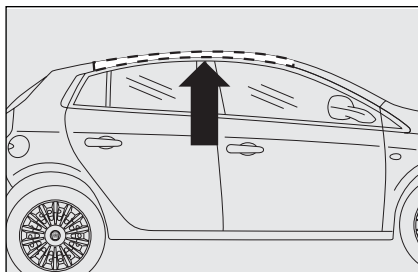

fig. 19

F0Q0703m

## WINDOW BAGS (where provided) fig. 19

They are “curtain” cushions located behind the side coverings of the roof and covered by proper finishings, studied for the head protection to offer the best protection to the front and rear occupants in the event of side crash, thanks to the wide cushion inflation surface.

In minor side crashes (for which the restraining action of the seat belts is sufficient), the air bags are not deployed.

Also in this case it is of vital importance to wear the seat belts since in case of side crash they guarantee proper positioning of the occupant and prevent the occupants to be pitched out of the car in case of violent crashes.

Therefore the front side bags (where provided) are not a replacement of but complementary to the belts, which you are recommended to always wear, as specified by law in Europe and most non-European countries.

**IMPORTANT** In the event of side crash, you can obtain the best protection by the system keeping a correct position on the seat, allowing thus a correct window bag unfolding.

**IMPORTANT** Do not wash seats with pressurised water or steam (by hand or at automatic seat washing stations).



### WARNING

*Do not hook rigid objects to the coat hooks and to the support handles.*



### WARNING

*Do not cover the backrest of front seats with trims or covers that are not suitable to be used with side bags.*



### WARNING

*Never rest head, arms and elbows on the door, on the windows and in the window bag area to prevent possible injuries during inflation phase.*



### WARNING

*Never lean head, arms and elbows out of the window.*

## GENERAL WARNINGS

1) The front air bags and/or front and front side bags (where provided) may be deployed if the car is subject to heavy knocks or accidents involving the underbody area, such as for example violent shocks, against steps, kerbs or low obstacles, falling of the car in big holes or sags in the road.

2) When the airbag inflates it emits a small amount of dusts. These dusts are harmless and is not the beginning of a fire; then the unfold cushion surface and the car interiors can be covered by a dusty remains: this dust can irritate skin and eyes. In case of contact, wash yourself using neutral soap and water.

3) Should an accident occur in which any of the safety devices is activated, take the car to a Fiat Dealership to have the devices activated replaced and to have the system checked.

Every control, repair and replacement operations concerning the air bags must only be carried out c/o Fiat Dealership.

If you are having the car scrapped, have the air bag system deactivated at a Fiat Dealership first. If the car changes ownership, the new owner must be informed of the method of use of air bags and the above warnings and also be given this "Owner Handbook".

4) The triggering of pretensioners, front air bags and front side bags is decided in a differentiated manner, depending on the type of crash. The failure to deploy one or more of them does not mean that the system is not working properly.

**WARNING**

If when turning the ignition key to **MAR**, the warning light  does not turn on or if it stays on when travelling (together with the message on the display) there could be a failure in safety systems; in this event air bags or pretensioners could not trigger in case of impact or, in a minor number of cases, they could trigger accidentally. Contact Fiat Dealership immediately to have the system checked.

**WARNING**

Life and validity of pyrotechnic charge and coil contact are indicated on the label located inside the lower oddment compartment. As this date approaches, contact Fiat Dealership to have them replaced.

**WARNING**

Never travel with objects on your lap, in front of your chest or with a pipe, pencil, etc. between your lips; injury may result in the event of the air bag being triggered.

**WARNING**

If the car has been stolen or an attempt to steal it has been made, if it has been subjected to vandals or floods, have the air bag system checked by Fiat Dealership.



### WARNING

Remember that with the key engaged and at MAR, even with the engine not running, the air bags may be triggered on a stationary car if it is bumped by another moving car. Therefore, never seat children on the front seat even when the car is stationary. On the other hand, remember that with the key at STOP no safety system (air bags or pretensioners) is triggered in the event of an impact; in this case, failure to come into action cannot be considered as a sign that the system is not working properly.



### WARNING

When the ignition key is turned to MAR, the warning light  (with passenger's front Air bag on) turns on and flashes for few seconds to remind that the passenger's air bag will be deployed in a crash, after which it should go off.



### WARNING

The front air bag is triggered for shocks greater in magnitude than the pretensioners. For impacts between these two thresholds, it is therefore normal that only the pretensioners are triggered.



**WARNING**

*The air bag does not substitute the seat belts, but only increases their effectiveness. Moreover, since the front air bags do not come into operation in the event of front impact at low speed, side collisions, bumps from behind or overturning, in these circumstances the occupants would only be protected by the seat belts which must therefore always be fastened.*

# CORRECT USE OF THE CAR

ENGINE STARTING .....	130
PARKING.....	133
USING THE GEARBOX.....	134
CONTAINING RUNNING COSTS .....	135
TOWING TRAILERS.....	137
SNOW TYRES.....	139
SNOW CHAINS.....	139
CAR INACTIVITY .....	140

DASHBOARD  
AND CONTROLS

SAFETY  
DEVICES

CORRECT USE  
OF THE CAR

WARNING  
LIGHTS AND  
MESSAGES

IN AN  
EMERGENCY

CAR  
MAINTENANCE

TECHNICAL  
SPECIFICATIONS

INDEX

## ENGINE STARTING

The car is fitted with an electronic engine lock device: if the engine fails to start, see the paragraph “The Fiat CODE system” in section “Dashboard and controls”.

The engine may be noisier than usual during the first seconds of operation, especially after it has not been used for a while. This characteristic feature of the hydraulic tappet system does not compromise functionality or reliability. This timing system for petrol engines was adopted to limit servicing.



Engine starting is guaranteed up to a minimum temperature of  $-18^{\circ}\text{C}$  (Italy and Middle Europe) and  $-20^{\circ}\text{C}$  (North Europe).

## STARTING PROCEDURE FOR PETROL VERSIONS

Proceed as follows:

- pull up the handbrake;
- set the gear lever to neutral;
- press the clutch pedal down to the floor without touching the accelerator;
- turn the ignition key to **AVV** and let it go the moment the engine starts.

If the engine does not start at the first attempt, return the ignition key to **STOP** before repeating starting.

If, when the ignition key is at **MAR**, warning light  remains (or the symbol on display) lit together with warning light , turn the key to **STOP** and then back to **MAR**; if the warning light remains on, try with the other keys provided with the car.



**We recommend that during the initial period you do not drive to full car performance (e.g.: excessive acceleration, long journeys at top speed, sharp braking, etc.).**



### WARNING

**Running the engine in confined areas is extremely dangerous. The engine consumes oxygen and produces carbon monoxide which is a highly toxic and lethal gas.**







**When the engine is switched off never leave the ignition key at MAR to prevent pointless current absorption from draining the battery.**

If you are still unable to start the engine, perform the emergency start-up procedure (see “Emergency start-up” in section “In an emergency”) and contact Fiat Dealership.

**IMPORTANT** Never leave the ignition key at **MAR** when the engine is off.

## STARTING PROCEDURE FOR DIESEL VERSIONS

Proceed as follows:

- Ensure that the handbrake is up;
- set the gear lever to neutral;
- turn the ignition key to **MAR**. The warning lights  and  (or the symbol on display) on the instrument panel will turn on;
- wait for the warning lights  (or the symbol on display) and  to turn off. The hotter the engine is, the quicker this will happen;
- press the clutch pedal down to the floor without touching the accelerator;
- turn the ignition key to **AVV** as soon as warning light  turns off. If you wait too long you will lose the benefit of the work done by the glow plugs. Release the key as soon as the engine starts.

**IMPORTANT** With cold engine, the accelerator pedal shall be completely released while turning the ignition key to **AVV**.

If the engine does not start at the first attempt, return the ignition key to **STOP** before repeating starting.

If, when the ignition key is at **MAR**, warning light  on the instrument panel (or the symbol on display) stays on, turn the key to **STOP** and then back to **MAR**; if the warning light remains on, try with the other keys provided with the car.

If you still cannot start the engine, contact Fiat Dealership.

**IMPORTANT** Never leave the ignition key at **MAR** when the engine is off.



*The warning light  will flash for 60 seconds at start-up or during prolonged cranking to signal a fault in the glow plug heating system. You can use the car as usual if the engine starts but you should contact a Fiat Dealership as soon as possible.*

## HOW TO WARM UP THE ENGINE AFTER IT HAS JUST STARTED (petrol and diesel engines)

Proceed as follows:

- Drive off slowly, letting the engine turn at medium revs. Do not accelerate abruptly;
- Do not drive at full performance for the initial kilometres. Wait until the coolant temperature gauge starts moving.

## EMERGENCY START-UP

If the instrument panel warning light  (or the symbol on display) stays on with fixed light, contact Fiat Dealership.

## STOPPING THE ENGINE

Turn the ignition to **STOP** while the engine is idling.

**IMPORTANT** After a taxing drive, you should allow the engine to “catch its breath” before turning it off by letting it idle to allow the temperature in the engine compartment to fall.



**Never bump start the engine by pushing, towing or coasting downhill as this could cause fuel to flow into the catalytic exhaust system and damage it beyond repair.**



### WARNING

**Remember that the servo-brake and power steering are not operational until the engine has been started, therefore much effort than usual is required on the brake pedal and steering wheel.**



**A quick burst on the accelerator before turning off the engine serves absolutely no practical purpose, it wastes fuel and is damaging especially to turbocharged engines.**

## PARKING

Proceed as follows:

- Stop the engine and engage the handbrake;
- Engage a gear (first if the car is faced uphill or reverse if it is faced downhill) and leave the wheels steered.

Block the wheels with a wedge or a stone if the car is parked on a steep slope. Do not leave the ignition key at **MAR** to prevent draining the battery. Always remove the key when you leave the car.

## HANDBRAKE

The handbrake lever is located between the two front seats.

Pull the handbrake lever upwards until the car cannot be moved.

Four or five clicks are generally enough when the car is on level ground while nine or ten may be required if the car is on a steep slope or laden.

**IMPORTANT** If this is not the case, contact Fiat Dealership to have the handbrake adjusted.

In cars fitted with front armrest, lift the latter so that it does not hinder the handbrake engaging procedure.

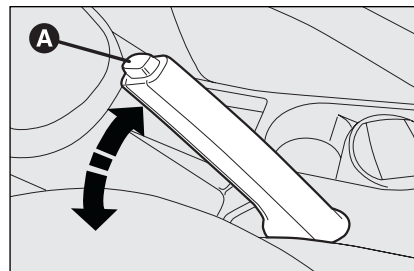

fig. 1

F0Q0628m



### WARNING

**Never leave children unattended in the car. Always remove the ignition key when leaving the car and take it out with you.**

When the handbrake lever is pulled up and the ignition key is at **MAR**, the instrument panel warning light (ⓘ) will turn on.

To release the handbrake:

- slightly lift the handbrake and press release button **A**-fig. 1;
- keep button **A** pressed and lower the lever. Warning light (ⓘ) will turn off.

Press the brake pedal when carrying out this operation to prevent the car from moving accidentally.

## USING THE GEARBOX

To engage the gears, press the clutch pedal fully and shift the gear lever into the required position (the diagram of gear position is shown on the knob **fig. 2** and **fig. 3**).

To engage 6<sup>th</sup> gear (1.416V, 1.4 T-JET and 1.9 Multijet 16V version ) press the lever to the right to prevent engaging 4<sup>th</sup> gear by mistake. A similar action is required to shift down from 6<sup>th</sup> to 5<sup>th</sup>.

**IMPORTANT** The car can only be put into reverse gear when it has stopped moving completely. With the engine running, before engaging the reverse, wait at least 2 seconds with the clutch pedal fully down to prevent damage and grating of the gears.

To engage reverse **R** from neutral, lift the sliding ring **A**-**fig. 2** or **A**-**fig. 3** under the knob and shift the lever to the right and back.

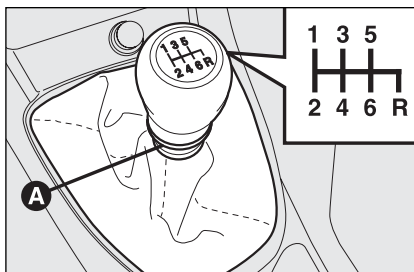

fig. 2

F0Q0734m

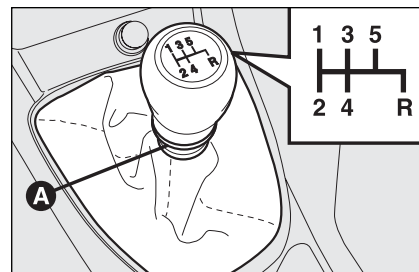

fig. 3

F0Q0602m



### WARNING

*To change gears properly you must push the clutch pedal fully down. It is therefore essential that there is nothing under the pedals: make sure the mats are lying flat and do not get in the way of the pedals.*



*Do not drive with your hand resting on the gear lever as the force exerted, even if slight, could lead over time to premature wear on the gearbox internal components.*

## CONTAINING RUNNING COSTS

Here are some suggestions which may help you to keep the running costs of your car down and lower the amount of toxic emissions released into the atmosphere.

### GENERAL CONSIDERATIONS

#### Car maintenance

Have checks and adjustments carried out in accordance with the “Service schedule”.

#### Tyres

Check the pressure of the tyres routinely at an interval of no more than 4 weeks: if the pressure is too low, consumption levels increase as resistance to rolling is higher.

#### Carichi inutili

Do not travel with too much luggage stowed in the boot. The weight of the car (especially when driving in town) and its trim greatly affects consumption and stability.

#### Roof rack/ski rack

Remove the roof rack or the ski rack from the roof as soon as they are no longer used. These accessories lower air penetration and adversely affect consumption levels. When needing to carry particularly voluminous objects, preferably use a trailer.

#### Electric devices

Use electric devices only for the amount of time needed. Rear heated window, additional headlights, windscreen wipers and heater fan need a considerable amount of energy, therefore increasing the requirement of current increases fuel consumption (up to +25% in the urban cycle).

#### Climate control

The air conditioner is an additional load which greatly affects the engine leading to higher consumption (on average up to +20%). When the temperature outside the car permits it, use the air vents where possible.

#### Spoilers

The use of non-certified aerodynamic items may adversely affect air drag and consumption levels.

DASHBOARD AND CONTROLS

SAFETY DEVICES

CORRECT USE OF THE CAR

WARNING LIGHTS AND MESSAGES

IN AN EMERGENCY

CAR MAINTENANCE

TECHNICAL SPECIFICATIONS

INDEX



## DRIVING STYLE

### Starting

Do not warm the engine with the car at a standstill or at idle or high speed: under these conditions the engine warms up much more slowly, increasing electrical consumption and emissions. It is therefore advisable to move off immediately, slowly, avoiding high speeds. This way the engine will warm faster.

### Unnecessary actions

Avoid accelerating when waiting at traffic lights or before switching off the engine. This and also double declutching is absolutely pointless on modern cars and also increase consumption and pollution.

### Gear selection

As soon as the conditions of the traffic and road allow, use a higher gear. Using a low gear to obtain brilliant performance increases consumption.

In the same way improper use of a high gear increases consumption, emissions and engine wear.

## Top speed

Fuel consumption considerably increases with speed. Avoid superfluous braking and accelerating, which cost in terms of both fuel and emissions.

## Acceleration

Accelerating violently increasing the revs will greatly affect consumption and emissions: acceleration should be gradual and should not exceed the maximum torque.

## CONDITIONS OF USE

### Cold starting

Short journeys and frequent cold starts do not allow the engine to reach optimum operating temperature. This results in a significant increase in consumption levels (from +15 to +30% on the urban cycle) and emission of harmful substances.

### Traffic situations and road conditions

Rather high consumption levels are tied to situations with heavy traffic, for example in queues with frequent use of the lower gears or in cities with many traffic lights. Also winding mountain roads and rough road surfaces adversely affect consumption.

### Traffic hold-ups

During prolonged hold-ups (traffic lights, level crossings) the engine should be switched off.

# TOWING TRAILERS

## IMPORTANT NOTES

For towing caravans or trailers the car must be fitted with a certified tow hook and an adequate electric system. Installation should be carried out by specialised personnel who release a special document for circulation on the road.

Install any specific and/or additional rear-view mirrors as specified by law.

Remember that when towing a trailer, steep hills are harder to climb, the braking spaces increase and overtaking takes longer depending on the overall weight.

Engage a low gear when driving downhill, rather than constantly using the brake.

The weight the trailer exerts on the car tow hook reduces by the same amount the actual car loading capacity. To make sure the maximum towable weight is not exceeded (given in the log book) account should be taken of the fully laden trailer, including accessories and personal belongings.

Do not exceed the speed limits of the country you are driving in. In any case do not exceed 80 km/h.

## INSTALLING THE TOW HOOK

The towing device should be fastened to the body by specialised personnel according to any additional and/or integrative information supplied by the Manufacturer of the device. The towing device must meet current regulations with reference to 94/20/EC Directive and subsequent amendments. For any version the towing device used must match the towable weight of the car on which it is to be installed.

**IMPORTANT** Supplementary electric loads other than external lights (e.g. electric brake, electric winch, etc.) shall be used with running engine.

For the electric connection a unified connector should be used which is generally placed on a special bracket normally fastened to the towing device, and a special ECU for external trailer light control shall be installed on the car.

For the electrical connection, 7 or 13 pin 12VDC connection is to be used (CU-NA/UNI and ISO/DIN Standards). Follow the instructions provided by the car manufacturer and/or the tow hitch manufacturer.

Any electric brake (or electric winch, etc.) should be supplied directly by the battery through a cable with a cross section of no less than 2.5 mm<sup>2</sup>.

**IMPORTANT** Electric brake or other device shall be used with running engine.

In addition to the electrical branches, the car electric system can only be connected to the supply cable for an electric brake and to the cable for an internal light, though not above 15W. For connections use the preset control unit with battery cable no less than 2.5 mm<sup>2</sup>.



### WARNING

**The ABS system with which the car may be fitted does not control the trailer braking system. Drive with extreme care on slippery roadbeds.**



### WARNING

**Under no circumstances should the car brake system be altered to control the trailer brake. The trailer braking system must be fully independent of the car's hydraulic system.**

### Assembly diagram fig. 4

The tow-hook structure must be secured at the points indicated with  with a total of 2 M8 bolts, 4 M10 bolts and 2 M12 bolts.

The hook should be fastened to the body avoiding any type of drilling and trimming of the rear bumpers that remains visible when the hook is removed.

After fitting, screw holes shall be sealed to prevent exhaust gas inlet.

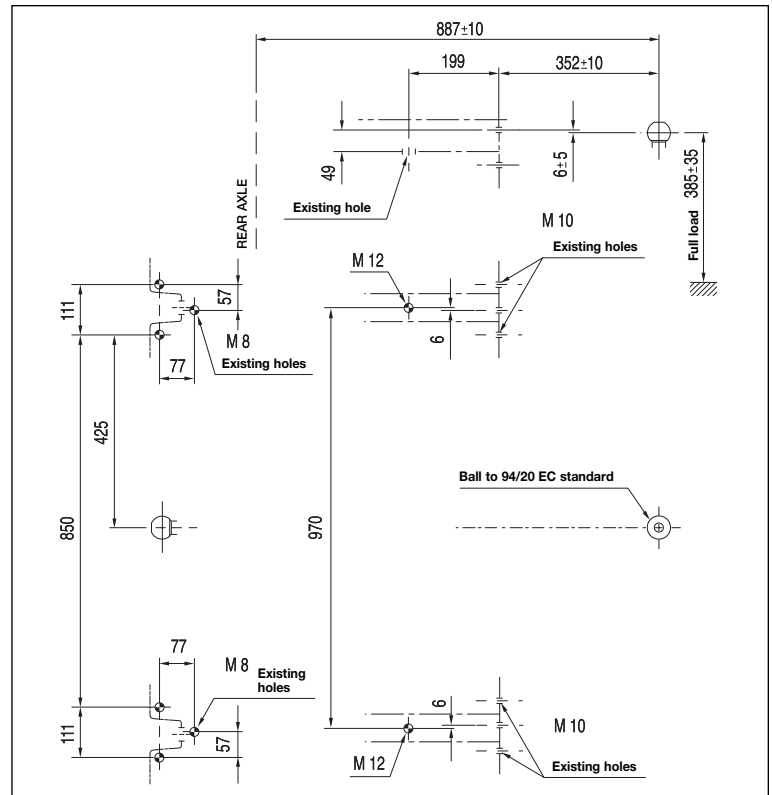

F0Q0249m

fig. 4

## SNOW TYRES

Use snow tyres of the same size as the normal tyres provided with the car.

Fiat Dealership will be happy to provide advice concerning the most suitable type of tyre for the customer's requirements.

For the type of tyre to be used, inflation pressures and the specifications of snow tyres, follow the instructions given in paragraph "Wheels" in section "Technical specifications".

The winter features of these tyres are reduced considerably when the tread depth is below 4 mm. In this case, they should be replaced.

Due to the snow tyre features, under normal conditions of use or on long motorway journeys, the performance of these tyres is lower than that of normal tyres. It is therefore necessary to limit their use to the purposes for which they are certified.

**IMPORTANT** When snow tyres are used with a max speed index below the one that can be reached by the car (increased by 5%), place a notice in the passenger's compartment, plainly in the driver's view which states the max permissible speed of the snow tyres (as per EC Directive).

All four tyres should be the same (brand and track) to ensure greater safety when driving and braking and better driveability.

Remember that it is inappropriate to change the direction of rotation of tyres.



### WARNING

*The max speed for snow tyres with "Q" marking is 160 km/h; 190 km/h for tyres with "T" marking and 210 km/h for tyres with H marking. The Road Traffic Code speed limits must however be always strictly observed.*

## SNOW CHAINS

Use of snow chains should be in compliance with local regulations.

Snow chains should only be applied to the driving wheels (front wheels).

Check the tension of the chains after the first few metres have been driven. Use snow chains with reduced size: for 195/65 R15" and 205/55 R16" tyres use snow chains with reduced size with max protrusion beyond the tyre profile of 9 mm.

**IMPORTANT** Snow chains cannot be fitted to the space-saver spare wheel. So, if a front wheel is punctured and chains are needed, a rear wheel should be fitted to the front of the car and the spare wheel should be fitted to the rear.

DASHBOARD  
AND CONTROLS

SAFETY  
DEVICES

CORRECT USE  
OF THE CAR

WARNING  
LIGHTS AND  
MESSAGES

IN AN  
EMERGENCY

CAR  
MAINTENANCE

TECHNICAL  
SPECIFICATIONS

INDEX

This way with two normal drive wheels, snow chains can be fitted to them to solve an emergency.

**IMPORTANT** Snow chains may not be used on tyres type 225/45 R17 91V and 225/40 R18 92V since interference can be generated with the surrounding components.



**Keep your speed down when snow chains are fitted. Do not exceed**

**50 Km/h. Avoid potholes, steps and pavements and avoid also to drive for long distances on roads not covered with snow to prevent damaging the car and the roadbed.**

## CAR INACTIVITY

If the car is to be left inactive for longer than a month, the following precautions should be noted:

- park the car in covered, dry and if possible well-ventilated premises;
- engage a gear;
- check that the handbrake is not engaged;
- disconnect the battery negative terminal;
- clean and protect the painted parts using protective wax;
- clean and protect the shiny metal parts using special compounds readily available.

- sprinkle talcum powder on the rubber windscreen and rear window wiper blades and lift them off the glass;
- slightly open the windows;
- cover the car with a cloth or perforated plastic sheet. Do not use sheets of non-perforated plastic as they do not allow moisture on the car body to evaporate;
- inflate tyres to +0,5 bar above the normal specified pressure and check it at intervals;
- do not drain the engine cooling system.

**IMPORTANT** Where relevant, switch off the car alarm with the remote control.

# WARNING LIGHTS AND MESSAGES

GENERAL WARNINGS .....	142	GLOW PLUG WARMING .....	149
LOW BRAKE FLUID.....	142	GLOW PLUG WARMING FAILURE.....	149
HANDBRAKE ON.....	142	WATER IN DIESEL FUEL FILTER .....	150
BRAKE PAD WEAR .....	142	ABS SYSTEM FAILURE.....	150
AIR BAG FAILURE .....	143	EBD SYSTEM FAILURE .....	150
FRONT PASSENGER AIR BAG/ SIDE BAGS DEACTIVATED.....	143	CAR PROTECTION SYSTEM FAILURE FIAT CODE.....	151
SEAT BELTS NOT FASTENED.....	144	ALARM FAILURE.....	151
LOW BATTERY CHARGE.....	144	THEFT ATTEMPT.....	151
LOW ENGINE OIL PRESSURE.....	144	LOW TYRE PRESSURE .....	151
EXHAUSTED OIL .....	144	CHECK TYRE PRESSURE .....	151
LOW ENGINE OIL LEVEL .....	145	TYRE PRESSURE UNSUITABLE FOR SPEED .....	151
“DUALDRIVE” ELECTRIC POWER STEERING FAILURE.....	145	EXTERNAL LIGHTS FAILURE.....	153
“DUALDRIVE” ELECTRIC POWER STEERING ACTIVATION .....	145	BRAKE LIGHTS FAILURE.....	153
ENGINE COOLANT HIGH TEMPERATURE.....	146	REAR FOGLIGHTS .....	153
INCOMPLETE DOOR LOCKING.....	146	FRONT FOG LIGHTS.....	153
BOOT OPEN.....	146	LEFT-HAND DIRECTION INDICATOR .....	153
BONNET OPEN.....	146	RIGHT-HAND DIRECTION INDICATOR .....	153
GENERIC FAILURE INDICATION .....	147	SIDE/TAILLIGHTS AND LOW BEAMS.....	154
DIESEL PARTICULATE FILTER CLOGGED .....	147	FOLLOW ME HOME .....	154
FUEL RESERVE.....	148	MAIN BEAMS.....	154
EOBD/INJECTION SYSTEM FAILURE .....	148	CRUISE CONTROL .....	154
ESP SYSTEM .....	149	POSSIBLE PRESENCE OF ICE ON THE ROAD.....	154
HILL HOLDER FAILURE .....	149	LIMITED RANGE .....	154
		ASR SYSTEM .....	154
		SPEED LIMIT EXCEEDED .....	154
		SPORT FUNCTION ACTIVATION .....	154

## WARNING LIGHTS AND MESSAGES

### GENERAL WARNINGS

Turning on of warning light and/or symbol is accompanied by specific message and/or by buzzer sound where provided by instrument panel. These indications are **concise and cautionary** and shall not be considered as exhaustive and/or as an alternative to the specifications contained in this Owner Handbook which shall always be read through carefully and thoroughly. In case of failure indication **always refer to the specifications contained in this section.**

**IMPORTANT** Failure indications displayed are divided into two categories: **very serious** and **less serious** failures.

**Very serious** failures are indicated by a repeated and prolonged warning “cycle”.

**Less serious** failures are indicated by a limited warning “cycle”.

The warning cycle of both failure classes can be stopped by pressing button **MODE**. The warning light (or symbol on the display) will stay on until eliminating the fault.



**LOW BRAKE FLUID LEVEL (red)**

**HANDBRAKE ON (red)**

Turning the ignition key to **MAR** the warning light turns on, but it should go off after few seconds.

### Low brake fluid level

The warning light turns on when the level of the brake fluid in the reservoir falls below the minimum level, due to possible leak in the circuit.

The display will show the dedicated message.



### WARNING

*If the (⚠) warning light turns on when travelling (together with the message on the display) stop the car immediately and contact Fiat Dealership.*

### Handbrake on

The warning light turns on when the handbrake is on.

If the car is moving, a buzzer will also sound.

**IMPORTANT** If the warning light turns on when travelling, check that the handbrake is not engaged.



**BRAKE PAD WEAR (amber)**

The warning light (or the symbol on the display) turns on if the front brake pads are worn; in this case have them changed as soon as possible.

The display will show the dedicated message.

**IMPORTANT** Since the car is fitted with wear sensors for the front brake pads, when changing them, check also the rear brake pads.



## AIR BAG FAILURE (red)

Turning the ignition key to **MAR** the warning light turns on, but it should go off after few seconds.

The warning light stays on glowing steadily if there is a failure in the air bag system.

The display will show the dedicated message.





### WARNING

*If when turning the ignition key to **MAR**, the warning light  does not turn on or stays on when travelling there could be a failure in safety systems; in this event air bags or pretensioners could not trigger in case of impact or, in a minor number of cases, they could trigger accidentally. Contact Fiat Dealership immediately to have the system checked.*





### WARNING

*The failure of the  warning light is also indicated by the flashing for more than the normal 4 seconds of the passenger's front air bag deactivated warning light . In addition the air bag system will deactivate automatically the passenger's air bags (front and side where provided). In this event, warning light  could not indicate safety systems failures. Contact Fiat Dealership immediately to have the system checked.*





## FRONT PASSENGER AIR BAG /SIDE BAGS DEACTIVATED (amber)

Warning light  will come on when deactivating the passenger front air bag and side bag (where provided). With passenger front air bag active, turning the ignition key to **MAR**, warning light  will turn on with fixed light for about 4 seconds and then it will flash for other 4 seconds. It shall then go off.



### WARNING

*The failure of the warning light  is indicated by the turning on of warning light . In addition the air bag system will deactivate automatically the passenger's air bags (front and side where provided). Contact Fiat Dealership immediately to have the system checked.*





## SEAT BELTS NOT FASTENED (red)

The warning light turns on glowing steadily with car stationary and driver's seat belt not fastened correctly. The warning light will turn on flashing together with the buzzer when, with car moving, front seat belts are not fastened correctly.

The S.B.R. (Seat Belt Reminder) buzzer can only be excluded by Fiat Dealership.

The system can be reactivated through the set-up menu.

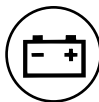

## LOW BATTERY CHARGE (red)

Turning the ignition key to **MAR** the warning light (where provided) turns on, but it should go out as soon as the engine is started (with the engine running at idle speed a brief delay in going out is allowed).

If the warning light (or the symbol on the display) stays on glowing steadily or flashing, contact immediately Fiat Dealership.



## LOW ENGINE OIL PRESSURE (red)

### EXHAUSTED OIL (red) (Multijet versions with DPF)

#### Low engine oil pressure

Turning the ignition key to **MAR** the warning light turns on, but it should go out as soon as the engine is started.

The display will show the dedicated message.



*If the warning light  turns on when the car is travelling (together with the message on the display), stop the engine immediately and contact a Fiat Dealership.*

## Exhausted oil (Multijet versions with DPF)

The warning light with turn on flashing when the system detects that the engine oil is exhausted.

After the first indication, at each engine starting the warning light  will go on flashing for about 1 minute and then every 2 hours until oil is changed.

The display will show the dedicated message.



*If warning light  flashes, contact Fiat Dealership as soon as possible to have oil changed and instrument panel warning light turned off.*



## LOW ENGINE OIL LEVEL (red)

Turning the ignition key to **MAR** the warning light (where provided) turns on, but it should go off after few seconds.

The warning light (or the symbol on the display) turns on when the oil level falls below the preset limit. Restore the proper engine oil level (see “Checking fluid levels” in section “Car maintenance”).

The display will show the dedicated message.



## “DUALDRIVE” ELECTRIC POWER STEERING FAILURE (red)

Turning the ignition key to **MAR** the warning light turns on, but it should go off after few seconds.

If the warning light (or the symbol on the display) stays on, you will not have steering assistance and the effort on the steering wheel will be increased, steering is however possible. Contact Fiat Dealership.

The display will show the dedicated message.



## “DUALDRIVE” ELECTRIC POWER STEERING ACTIVATION (green or symbol on the display)

The warning light (or the word CITY on the display) turns on when the “Dualdrive” electric power steering is activated by pressing the relevant control button. Pressing the button again will turn off the word CITY.

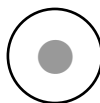

## ENGINE COOLANT HIGH TEMPERATURE (red)

Turning the ignition key to **MAR** the warning light turns on, but it should go off after few seconds.

The warning light turns on when the engine is overheated.

If the warning light comes on, proceed as follows:

- **normal driving conditions:** stop the car, switch off the engine and check whether the water level in the reservoir is not below the MIN mark. Otherwise wait for few seconds to allow engine cooling, then open slowly and carefully the cap, top up coolant and check whether its level is falling between MIN and MAX marks in the reservoir. Check visually any leak and if when restarting the warning light comes on again, contact a Fiat Dealership.

- **Car heavy duty** (e.g.: towing trailer uphill of fully laden car): decrease speed, if the warning light stays on, stop the car. Wait for 2 or 3 minutes leaving the engine on and slightly accelerated to further activate the circulation of the coolant fluid, then switch the engine off. Check proper coolant level as described previously.

**IMPORTANT** Under severe use of the car, keep the engine on and slightly accelerated for few minutes before switching it off.

The display will show the dedicated message.



## INCOMPLETE DOOR LOCKING (red)

The warning light (or the symbol on the display) turns on when one or more doors are not properly shut.

The buzzer will sound when one or more doors are open and the car is moving.



## BOOT OPEN

The symbol (where provided) on the display turns on when the boot is not properly shut.

On certain versions the warning light  turns on instead.



## BONNET OPEN

The symbol (where provided) on the display turns on when the bonnet is not properly shut.

On certain versions the warning light  turns on instead.



## GENERIC FAILURE INDICATION (amber)

### Inertial fuel cut-off switch intervened

The warning light (or the symbol on display) comes on when the inertial fuel cut-off switch is triggered.

The display will show the dedicated message.

### Engine oil pressure sensor failure

The warning light (or the symbol on the display) turns on when a fault is detected to engine oil pressure sensor.

### Twilight sensor failure

The warning light (or the symbol on display) turns on when a fault is detected to the twilight sensor.

The display will show the dedicated message.

### Speed limit exceeded (only for Arabic countries)

The warning light (amber), or symbol on the display (red), comes on when a speed of 120 km/h is exceeded.

### Rain sensor failure

The warning light (or the symbol on the display) on the dial turns on when the rain sensor is faulty. Contact Fiat Dealership.

The display will show the dedicated message.

### Parking sensors failure (where provided)

The warning light (or the symbol on the display) when a fault is detected to parking sensors.

### Tyre pressure monitoring system failure (where provided)

The warning light (or the symbol on the display) turns on when a failure is detected in the T.P.M.S. system (where provided).

Should one or more wheels without sensor be fitted, the instrument panel warning light will come on and stay on until restoring initial conditions.

The display will show the dedicated message.

NOTE When one of the above faults occurs, contact your Fiat Dealership as soon as possible.

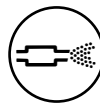

## DIESEL PARTICULATE FILTER CLOGGED (amber) (Multijet versions)

Turning the ignition key to **MAR** the warning light turns on, but it should go off after few seconds.

The warning light turns on when the diesel particulate filter is clogged and the driving conditions do not enable to activate automatically the reclaiming procedure.

To enable the cleaning procedure, keep the car running until the warning light turns off.

The display will show the dedicated message.

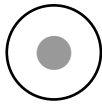

### FUEL RESERVE (amber)

Turning the ignition key to **MAR** the warning light turns on, but it should go off after few seconds.

The warning light turns on when about 8 litres fuel are left in the tank.

**IMPORTANT** The warning light flashes to indicate a failure, contact Fiat Dealership as soon as possible to have the system checked.



### EOBD/INJECTION SYSTEM FAILURE (amber)

Under normal conditions, turning the ignition key to **MAR**, the warning light turns on, but it should go off when the engine has started.

If the warning light stays on or turns on when travelling, means a fault in the supply/ignition system which could cause high emissions at the exhaust, possible lack of performance, poor handling and high consumption levels.

The display will show the dedicated message.

In these conditions it is possible to continue driving without however requiring heavy effort or high speed from the engine. Prolonged use of the car with the warning light on may cause damages. Contact Fiat Dealership as soon as possible.



The warning light turns off if the fault disappears, but it is still stored by the system.

### Petrol engines only

Warning light turning on flashing indicates the possibility of damage to the catalyst.

If the light flashes, it is necessary to release the accelerator pedal to lower the speed of the engine until the warning light stops flashing; continue the journey at moderate speed, trying to avoid driving conditions that may cause further flashing and contact Fiat Dealership as soon as possible.



**If, turning the ignition key to MAR, the warning light  does not turn on or if it turns on glowing steadily or flashing when travelling (on certain versions together with the message on the display), contact Fiat Dealership as soon as possible. Warning light  operation can be checked by traffic agents by proper equipment. Comply with laws and regulations of the country where you are driving.**



### ESP SYSTEM (amber)

Turning the ignition key to **MAR** the warning light turns on, but it should go off after few seconds.

If the warning light does not turn off or stays on when travelling together with the button led ASR, contact Fiat Dealership.

On certain versions the dedicated message is displayed.

Warning light flashing when driving indicates that the ESP system is active.



### HILL HOLDER FAILURE (amber)

The symbol  will turn on when the Hill Holder system is faulty. Contact Fiat Dealership as soon as possible.



On certain versions warning light  turns on as an alternative.

The display will show the dedicated message.

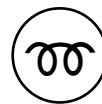

### GLOW PLUG WARMING (Multijet versions) (amber)

### GLOW PLUG WARMING FAILURE (Multijet versions) (amber)

#### Glow plug warming

Turning the ignition key to **MAR** the warning light turns on and it will go off when glow plugs reach the preset temperature. Start the engine immediately after warning light turning off.

**IMPORTANT** With high ambient temperature, warning light stays on for very short time.

#### Glow plug warming failure

The warning light turns on when there is a failure in the glow plug warming system. Contact Fiat Dealership as soon as possible.

The display will show the dedicated message.



### WATER IN DIESEL FUEL FILTER (Multijet versions) (amber)

Turning the ignition key to **MAR** the warning light turns on, but it should go off after few seconds.

The warning light turns on when there is water in the diesel fuel filter.

The display will show the dedicated message.



*The presence of water in the fuel circuit may cause serious damage to the entire injection system and cause irregular engine operation. If the warning light  turns on (together with the message on the display), contact Fiat Dealership as soon as possible to have the system relieved. If the above indications come on immediately after refuelling, water has probably been poured into the tank: turn the engine off immediately and contact Fiat Dealership.*

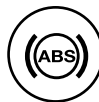

### ABS SYSTEM FAILURE (amber)

Turning the ignition key to **MAR** the warning light turns on, but it should go off after few seconds.



The warning light turns on when the system is inefficient or unavailable. In this case the braking system keeps its effectiveness unchanged, but without the potential offered by the ABS system.

Caution is advisable and it is necessary to contact Fiat Dealership.

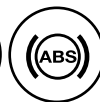
The display will show the dedicated message.



### EBD SYSTEM FAILURE (red) (amber)

The turning on at the same time of warning lights  and  with the engine running indicates an EBD system failure or that the system is unavailable; in this case heavy braking may cause the rear wheels to lock before time, with the possibility of skidding.

Drive with the utmost care to the nearest Fiat Dealership to have the system checked.

The display will show the dedicated message.



## CAR PROTECTION SYSTEM FAILURE - FIAT CODE (amber)

### ALARM FAILURE (where provided) (amber)



### THEFT ATTEMPT (amber)

## Car protection system failure - Fiat Code

Turning the key to **MAR** the warning light shall flash only once and then go off.

The turning on of the warning light (or the symbol on the display) glowing steadily, with the ignition key at **MAR**, indicates a probable failure (see “Fiat Code system” in section “Dashboard and controls”).

The display will show the dedicated message.

**IMPORTANT** The turning on at the same time of warning lights  and  (or symbol on display) indicates a failure of the Fiat CODE system.

If with the engine running the warning light  flashes, this means that the car is not protected by the engine immobilising device (see “Fiat Code system” in section “Dashboard and controls”).

Contact Fiat Dealership to have all the keys memorised.

## Alarm failure (where provided)

The turning on of the warning light (or symbol on display) indicates a failure in the alarm system. Contact Fiat Dealership as soon as possible.

The display will show the dedicated message.

### Theft attempt

The turning on of the warning light (or symbol on display) indicates an attempt of break-in. Contact Fiat Dealership as soon as possible.

The display will show the dedicated message.



## LOW TYRE PRESSURE (where provided) (amber-red)

### CHECK TYRE PRESSURE (where provided) (amber)

### TYRE PRESSURE UNSUITABLE FOR SPEED (where provided) (amber)

Turning the ignition key to **MAR** the warning light (where provided) will turn on, but it should go off after a few seconds.

## Low tyre pressure

The warning light (amber) or symbol on the display (red) come on if the pressure of one or more tyres drops below a pre-set threshold. In this way, the TPMS system notifies the driver by indicating that the tyre/s is dangerously deflated and is therefore probably punctured.

**IMPORTANT** Stop immediately with one or more tyres flat, avoid braking sharply and abrupt turns. Replace immediately the punctured tyre with the space-saver spare wheel (where provided) or repair the puncture tyre using the proper kit (see paragraph “If a tyre is punctured” in section “In an emergency”) and then contact Fiat Dealership as soon as possible.



## Check tyre pressure

The warning light (or the symbol on the display) turns on to indicate the flat tyre.

Should two or more tyre be flat, the display will show the indications corresponding to each tyre in sequence.

Restore proper inflation pressure values as soon as possible (see paragraph “Cold inflation pressures” in section “Technical Specifications”).

## Tyre pressure unsuitable for speed

Should it be required to journey at a speed higher than 160 km/h, inflate tyres at pressures values specified in paragraph “Inflation pressures”.

If the T.P.M.S. system (where provided) detects that the pressure of one or more tyres is unsuitable for the current speed, the warning light will turn on (together with the message on the display) (see paragraph “Low tyre pressure” in this section) and it will stay on until the car speed slows down below the preset threshold.

**IMPORTANT** In this case slow down immediately since tyre overheating could impair tyre performance and life beyond repair, and even make the tyre to blow-out.



### WARNING

**Strong radio-frequency noises could inhibit the regular operation of the T.P.M.S. system. This condition will be indicated by a message (where provided). The warning message will go off automatically as soon as the radio-frequency noise will stop to disturb the system.**



### EXTERNAL LIGHTS FAILURE (amber)

The warning light (or the symbol on the display) turns on when one of the following lights is failing:

- side/taillights
- brake lights or relevant fuse (see what described for symbol )
- rear fog lights
- direction indicators
- number plate lights.

The failure referring to these lights could be: one or more blown bulbs, a blown protection fuse or an electric connection cut-off.

The display will show the dedicated message.



### BRAKE LIGHTS FAILURE (amber)

The symbol on the display turns on when a failure at brake lights (stop) is detected.

The failure could be due to: blown bulb, blown protection fuse or electric connection cut-off.

On certain versions warning light  turns on as an alternative.



### REAR FOG LIGHTS (amber)

The warning light turns on when the rear fog lights are turned on.



### FRONT FOG LIGHTS (green)

The warning light turns on when the front fog lights are turned on.

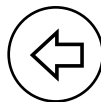

### LEFT-HAND DIRECTION INDICATOR (green - intermittent)

The warning light turns on when the direction indicator stalk is moved downwards or, together with the right indicator, when the hazard warning light button is pressed.

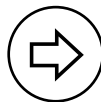

### RIGHT-HAND DIRECTION INDICATOR (green - intermittent)

The warning light turns on when the direction indicator stalk is moved upwards or, together with the left indicator, when the hazard warning light button is pressed.

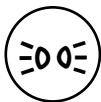

## SIDE/TAILLIGHTS AND LOW BEAMS (green)

### FOLLOW ME HOME

#### Side/taillights and low beams

The warning light turns on when side/taillights, parking lights or low beams are turned on.

#### Follow me home

The warning light will turn when this device is active (see “Follow me home” in section “Dashboard and controls”).

The display will show the dedicated message.



## MAIN BEAMS (blue)

The warning light turns on when the main beams are turned on.



## CRUISE CONTROL (where provided) (green)

Turning the ignition key to **MAR** the warning light turns on, but it should go off after few seconds.

The warning light turns on when turning the Cruise Control knurled ring to **ON**.

The display will show the dedicated message.

## POSSIBLE PRESENCE OF ICE ON THE ROAD

This indication starts flashing and symbol ❄️ is displayed when the outside temperature reaches or falls below 3°C to warn the driver of the possible presence of ice on the road.

The display will show the dedicated message.

## LIMITED RANGE

The display will show the dedicated message to warn the driver that the cruising range is less than 50 km.

## ASR SYSTEM

The ASR system can be turned off by pressing the ASR OFF button. The display will show the dedicated message to warn the driver that the system is off; at the same time the button led will turn on.

Pressing again the ASR OFF button will turn off the button led and the display will show the dedicated message to warn the driver that the system is active again.

## SPEED LIMIT EXCEEDED

The display will show the dedicated message when the car exceeds the speed limit set on setup menu.

## SPORT FUNCTION ACTIVATION

The S symbol lights up on the instrument panel when the same function is activated by pressing the relevant control button. The S symbol goes off when the button is pressed again.

# IN AN EMERGENCY

ENGINE STARTING .....	156
IF A TYRE IS PUNCTURED .....	157
QUICK TYRE REPAIR KIT FIX & GO automatic .....	163
WHEN NEEDING TO CHANGE A BULB .....	167
IF AN EXTERIOR LIGHT BURNS OUT .....	170
IF AN INTERIOR LIGHT BURNS OUT .....	175
IF A FUSE BLOWS .....	178
IF THE BATTERY IS FLAT .....	188
JACKING THE CAR .....	189
TOWING THE CAR .....	189

DASHBOARD  
AND CONTROLS

SAFETY  
DEVICES

CORRECT USE  
OF THE CAR

WARNING  
LIGHTS AND  
MESSAGES

IN AN  
EMERGENCY

CAR  
MAINTENANCE

TECHNICAL  
SPECIFICATIONS

INDEX

## ENGINE STARTING

### JUMP STARTING

If the battery is flat, it is possible to start the engine using an auxiliary battery with the same capacity or a little higher than the flat one.

Proceed as follows **fig. 1**:

- Connect positive terminals (+ near the terminal) of the two batteries with a jump lead;
- With a second lead, connect the negative terminal (-) of the auxiliary battery and to an earthing point  on the engine or the gearbox of the car to be started;
- Start the engine;
- When the engine has been started, remove the leads reversing the order above.

If after a few attempts the engine does not start, do not insist but contact the nearest Fiat Dealership.

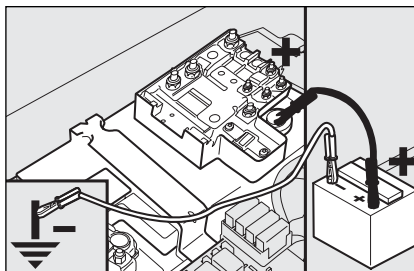

fig. 1

**IMPORTANT** Do not directly connect the negative terminals of the two batteries: sparks could ignite the flammable gas from the battery. If the other battery is fitted in another car, prevent accidental contacts between the metal parts of the two cars.



**Under no circumstances should a battery charger be used to start the engine: it could damage the electronic systems and in particular the ignition and injection control units.**



### WARNING

**Do not carry out this procedure if you lack experience; if it is not done correctly it can cause very intense electrical discharges. In addition, the fluid contained in the battery is poisonous and corrosive. Avoid contact with skin and eyes. You are also advised not to put naked flames or lighted cigarettes near the battery and not to cause sparks.**

### BUMP STARTING

Never bump start the engine (by pushing, towing, or coasting downhill) as this could cause fuel to flow into the catalytic exhaust system and damage it beyond repair.

**IMPORTANT** Remember that the servo-brake and electrical power steering system are not operating until the engine is started, a greater effort will therefore be required to press the brake pedal or turn the steering wheel.

## IF A TYRE IS PUNCTURED

The car is provided with the “Quick tyre repair kit Fix&Go automatic“: see the relevant instructions for use in next chapter.

### GENERAL INSTRUCTIONS

As an alternative to the Fix&Go kit, the car can be provided (upon request) with space-saver spare wheel or standard size spare wheel; wheel changing and correct use of the jack and space-saver spare wheel call for some precautions as listed below.



#### WARNING

*Alert other drivers that the car is stationary in compliance with local regulations: hazard warning lights, warning triangle, etc. Any passengers on board should leave the car, especially if it is heavily laden. Passengers should stay away from oncoming traffic while the wheel is being changed. If parked on a slope or rough surface, chock the wheels with wedges or other suitable devices to prevent the car from rolling.*



#### WARNING

*The space-saver spare wheel (where provided) is specific to your car, do not use it on other models, or use the spare wheel of other models on your car. The space-saver spare wheel shall only be used in an emergency. It shall only be used for the distance necessary to reach a service point and the car speed shall not exceed 80 Km/h. The spare wheel has an orange sticker that summarises the main cautions for use and limitations. The sticker should never be removed or covered. Never fit a wheel cap on a space-saver spare wheel. The sticker gives the following information in four languages: caution! For temporary use only! 80 km/h max! Replace by normal wheel as soon as possible. Do not cover this label.*

DASHBOARD  
AND CONTROLS

SAFETY  
DEVICES

CORRECT USE  
OF THE CAR

WARNING  
LIGHTS AND  
MESSAGES

IN AN  
EMERGENCY

CAR  
MAINTENANCE

TECHNICAL  
SPECIFICATIONS

INDEX

**WARNING**

When driving with a space-saver spare wheel fitted, the driving performance of the car changes. Avoid accelerating or braking sharply, abrupt turns or fast cornerings. The life of the spare wheel is approx. 3000 Km, after this distance it should be replaced with another of the same type. Never attempt to fit a conventional tyre on a rim designed for use as a space-saver spare wheel. Have the punctured wheel repaired and refitted as soon as possible. Two or more space-saver spare wheels should never be used together. Do not grease the threads of bolts before installing them: they might slip out.

**WARNING**

The jack shall only be used for changing wheels on the car with which it is provided or on cars of the same model. It must not be used for other purposes such as for instance raising cars of other models. In no case should it be used for repairs under the car. Incorrect positioning of the jack may cause the jacked car to fall. Do not use the jack for higher capacities than stated on its label. Snow chains cannot be fitted to the space-saver spare wheel. So, if a front (drive) wheel is punctured and chains are needed, a rear wheel should be fitted to the front of the car and the spare wheel should be fitted to the rear. This way with two normal drive wheels, snow chains can be fitted to them to solve an emergency.

**WARNING**

Fasten the wheel cap correctly to prevent the wheel from coming free in motion. Never tamper with the inflation valve. Never place tools between the rim and tyre. Check and restore, if required, the pressure of tyres and spare wheel to the values given in section "Technical specifications".

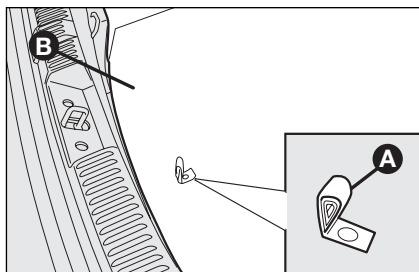

fig. 2

FOQ0732m

Please note:

- the jack weight is 1,76 kg;
- the jack requires no adjustment;
- the jack cannot be repaired: if it breaks it must be replaced with a new genuine jack;
- no tool other than its cranking device may be fitted on the jack.

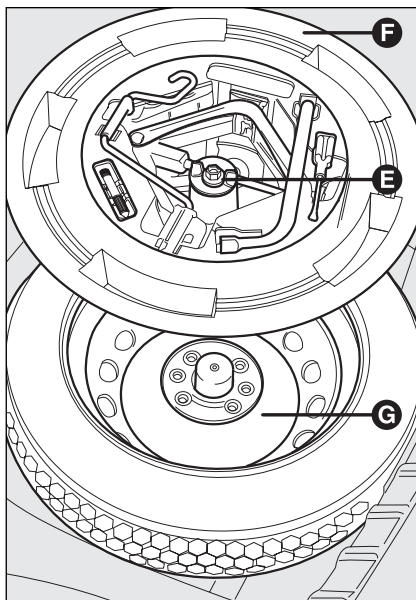

fig. 3

FOQ0392m

To change a wheel proceed as follows:

- Stop the car in a position that is not dangerous for oncoming traffic where you can change the wheel safely. The ground should be flat and adequately firm;
- turn the engine off and pull up the hand-brake; engage first gear or reverse;
- use the handle **A-fig. 2** to remove the piece of stiff cover **B**; loosen the clamping device **E-fig. 3**;

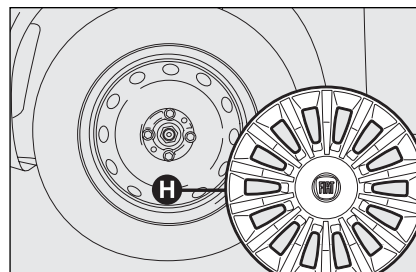

fig. 4

FOQ0393m

- for versions with Fix&Go automatic or take the tool kit from the luggage compartment;
- for versions with small spare wheel, unscrew the retaining device **E-fig. 3**, take the tool kit **F**, place near to the wheel to be replaced and then take the small spare wheel **G**;
- remove wheel hubcap **H-fig. 4** (versions with steel rims) or remove the hub cap (versions with alloy rims);



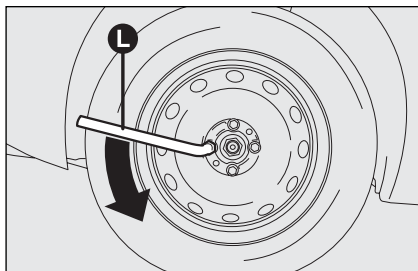

fig. 5

F0Q0394m

- using the wrench provided **L-fig. 5** loosen the fastening bolts by about one turn; if the car is fitted with alloy rims, shake the car to facilitate removing this rim from the wheel hub;
- work the jack crank **M-fig. 6** to extend it until the groove **N** on the upper part of the jack is correctly inserted on the lower profile **P** of the body in point **Q** (at approx. 72 cm from the front wheel centre or 75 cm from rear wheel centre);

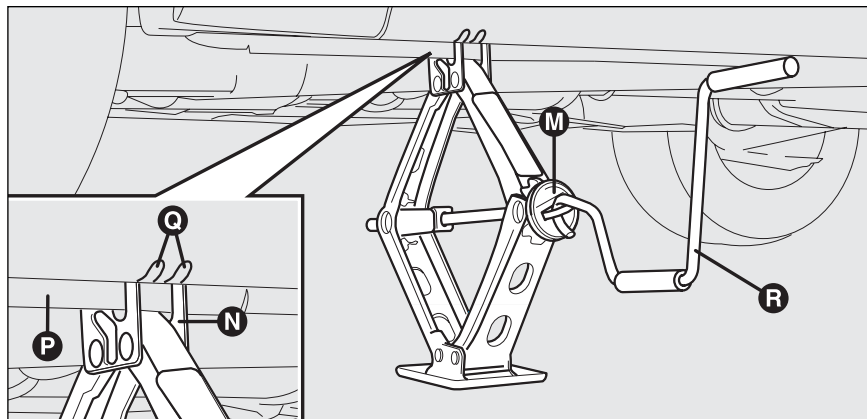

fig. 6

F0M0395m

- warn anybody nearby that the car is about to be lifted. They must stay clear and not touch the car until it is back on the ground;
- fit the handle **R-fig. 6** to operate the jack and raise the car until the wheel is a few centimetres from the ground;
- undo the wheel bolts and remove the wheel.
- make sure the contact surfaces between spare wheel and hub are clean so that the fastening bolts will not come loose;

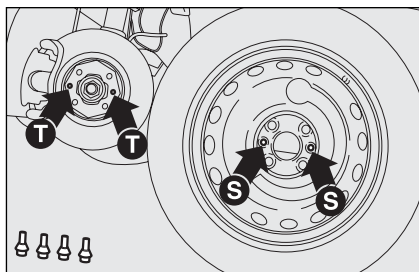

fig. 7

F0Q0396m

- install the space-saver spare wheel matching the holes **S**-fig. 7 with the corresponding pins **T**;
- using the wrench provided, fully tighten the four fastening bolts;
- work the jack handle **R**-fig.6 to lower the car and remove the jack;
- using the wrench provided, tighten up the wheel bolts in a criss-cross fashion following the sequence shown in fig. 8.

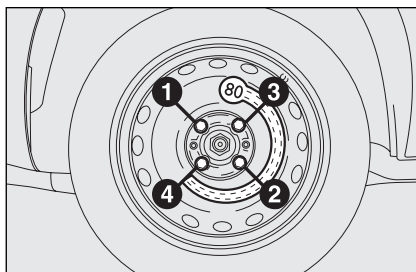

fig. 8

F0Q0397m

## REFITTING THE STANDARD WHEEL

Following the procedure described previously, raise the car and remove the spare wheel.

### For versions with steel rim

Proceed as follows:

- Make sure the contact surfaces between standard wheel and hub are clean so that the fastening bolts will not come loose;
- Fit the normal wheel matching the holes **S**-fig. 7 with the corresponding pins **T**;

- Using the wrench provided, tighten the fastening bolts;
- Lower the car and remove the jack;
- Using the wrench provided, fully tighten the bolts in the sequence shown in fig. 8;
- Place the cap near the wheel so that the inflation valve can come through the slot provided on the cap;
- Press the circumference of the cap, starting from the parts nearest the inflation valve until it is inserted completely.

**IMPORTANT** Incorrect fitting may cause the wheel cap to come off when the car is travelling.

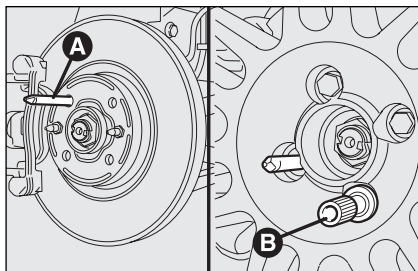

fig. 9

FOQ0217m

### Versions with alloy rims

Proceed as follows:

- tighten pin **A**-fig. 9 in one of the holes of the wheel hub fastening bolts;
- Insert the wheel on the pin and, using the wrench provided, tighten the bolts available. This is facilitated by the extension provided **B**;
- Loosen the pin **A** and tighten the last fastening bolt;
- Lower the car and remove the jack;
- Using the wrench provided, fully tighten the bolts in the sequence shown previously for the space-saver spare wheel (see fig. 8).
- refit the hubcap.

### When you have finished

- Stow the space-saver spare wheel **G**-fig. 10 in the space provided in the boot;
- Insert the partially open jack into the container **F** and force it slightly into its seat so that it does not vibrate when the car is moving;
- Put the tools back into their places in the container;
- Stow the container complete with tools on the spare wheel and secure everything with the clamping device **E**;
- Correctly reposition the boot stiff cover.

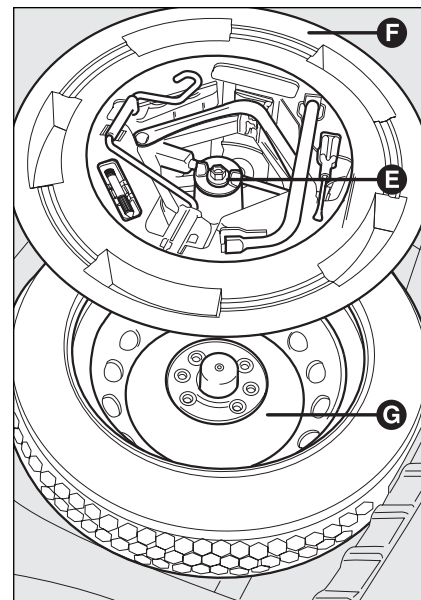

fig. 10

FOQ0392m

## QUICK TYRE REPAIR KIT FIX & GO automatic

The quick tyre repair kit Fix & Go automatic is located in the appropriate container in the boot .

The quick tyre repair kit includes **fig. 11** :

- bottle **A** containing sealer and fitted with:
  - filler hose **B**
  - sticker **C** with caution “max. 80 km/h”, to be affixed in a visible position for the driver (instrument panel) after repairing the tyre
- instruction brochure (see **fig. 12**), to be used for prompt and proper use of the quick repair kit and to be then handed to the personnel charged with handling the treated tyre
- compressor **D** including gauge and connections
- a pair of protection gloves located in the side space of the compressor
- adapters for inflating different elements.

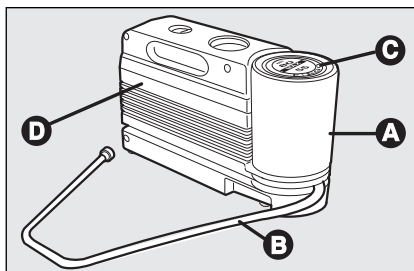

fig. 11

F0Q0510m

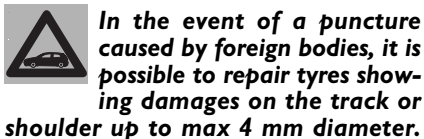
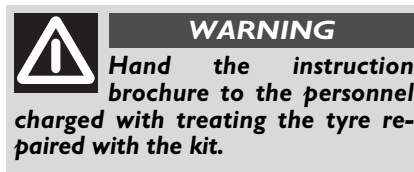
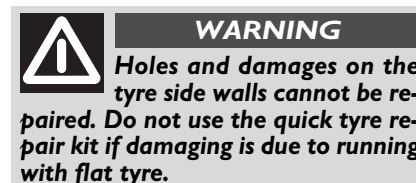

fig. 12

F0Q0511m



**IT SHOULD BE NOTICED THAT:**

The sealing fluid of the quick tyre repair kit is effective with external temperatures between  $-20\text{ }^{\circ}\text{C}$  and  $+50\text{ }^{\circ}\text{C}$ .

**WARNING**

*The compressor shall not be operated for more than 20 minutes. Risk of overheating!. Tyres repaired with the quick tyre repair kit shall be used temporarily only.*



*Do not throw away the cylinder and the sealing fluid. Have the sealing fluid and the cylinder disposed of in compliance with national and local regulations.*

**WARNING**

*The cylinder contains ethylene glycol. The cylinder contains latex: it can cause allergic reactions. It is harmful if ingested or inhaled and irritant for the eyes and in case of contact. In case of contact rinse immediately with water and take off contaminated clothes. If swallowed, do not induce vomit, rinse out the mouth, drink a lot of water and call the doctor immediately. Keep away from children. This product must not be used by asthmatics. Do not inhale vapours. Call the doctor immediately in case of allergic reactions. Keep the cylinder in the space provided for the purpose and far from heat. The sealing fluid has limited life. Replace the cylinder if sealer has run out.*

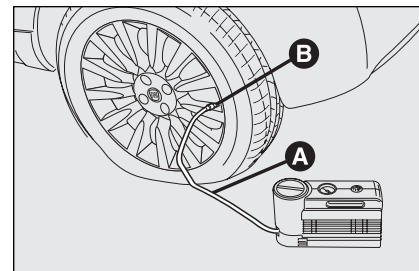

fig. 13

F0Q0513m

**INFLATING PROCEDURE****WARNING**

*Put on the protection gloves provided together with quick tyre repair kit.*

- Pull up the handbrake.** Loosen tyre inflation valve cap, take out the filler hose **A**-fig. 13 and screw the ring nut **B** on the tyre valve;

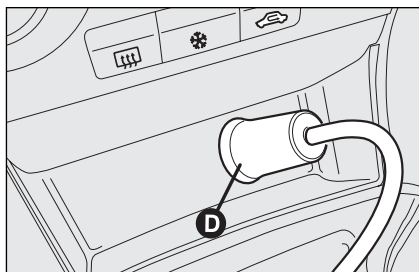

fig. 14

F0Q0515m

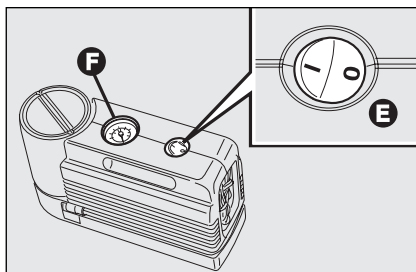

fig. 15

F0Q0516m

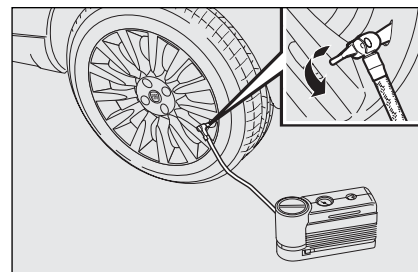

fig. 15a

F0Q0017m

□ make sure the compressor switch **E-fig. 15** is set to **0** (off), start the engine and fit plug **D-fig. 14** into the cigar lighter outlet and then turn on the compressor by setting switch **E-fig. 15** to **1** (on). Inflate the tyre to the pressure specified in paragraph “Cold tyre inflation pressure” in section “Technical specifications”. Check tyre pressure on gauge **F-fig. 15** with compressor off to obtain precise reading;

□ If after 5 minutes it is still impossible to reach at least 1.5 bar, disengage compressor from valve and current outlet, then move the car forth for approx. ten metres in order to distribute the sealing fluid inside the tyre evenly, then repeat the inflation operation;

□ If after this operation it is still impossible after 5 minutes to reach at least 1.8 bar, do not start driving since the tyre is excessively damaged and the quick tyre repair kit cannot guarantee suitable sealing, contact Fiat Dealership;

□ If reaching the tyre pressure specified in paragraph “Cold tyre inflation pressure” in section “Technical specifications”, start driving immediately;



### WARNING

*Apply the sticker in a visible position for the driver to indicate that the tyre has been treated with the quick tyre repair kit. Drive carefully especially when cornering. Do not exceed 80 km/h. Avoid heavy braking and accelerating.*

□ after driving for about 10 minutes stop and check again the tyre pressure; **pull up the handbrake**;



### WARNING

*If the pressure falls below 1.8 bars, do not drive any further: the quick tyre repair kit Fix & Go automatic cannot guarantee proper hold because the tyre is too much damaged. Contact Fiat Dealership.*

- if at least 1.8 bar pressure is read, restore proper pressure (with engine running and handbrake on) and restart;
- drive with the utmost care to the nearest Fiat Dealership.



### WARNING

*It is of vital importance to communicate that the tyre has been repaired using the quick tyre repair kit. Hand the instruction brochure to the personnel charged with treating the tyre repaired with the kit.*

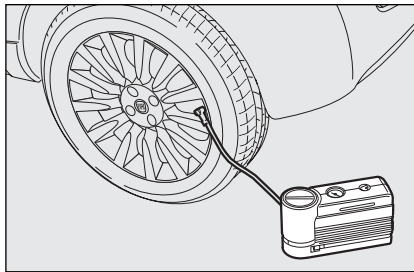

fig. 16

F0Q0517m

### FOR CHECKING AND RESTORING PRESSURE ONLY

The compressor can be also used just for restoring pressure. Disconnect the quick connection and connect it directly to the tyre valve **fig. 16**; in this way the cylinder is not connected to compressor and the sealing fluid will not flow into the tyre.

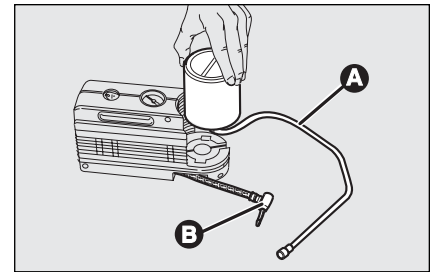

fig. 17

F0Q0512m

### CYLINDER REPLACEMENT PROCEDURE

To replace the cylinder proceed as follows:

- disconnect connection **B**-**fig. 17**;
- turn counter-clockwise the cylinder to replace and raise it;
- fit the new cylinder and turn it clockwise;
- connect connection **B** to the cylinder and fit the transparent tube **A** into the proper space.

## WHEN NEEDING TO CHANGE A BULB

### GENERAL INSTRUCTIONS

- ❑ When a light is not working, check that the corresponding fuse is intact before changing a bulb. For the location of fuses, refer to the paragraph “If a fuse blows” in this section;
- ❑ Before changing a bulb check the contacts for oxidation;
- ❑ Burnt bulbs must be replaced by others of the same type and power;
- ❑ Always check the height of the headlight beam after changing a bulb.



**Halogen bulbs must be handled touching only the metallic part. If the transparent bulb is touched with the fingers, its lighting intensity is reduced and life of the bulb may be compromised. If touched accidentally, rub the bulb with a cloth moistened with alcohol and allow to dry.**



### WARNING

**Modifications or repairs to the electrical system (electronic control units) carried out incorrectly and without bearing the features of the system in mind can cause malfunctions with the risk of fire.**



### WARNING

**Halogen bulbs contain pressurised gas which, if broken, may cause small fragments of glass to be projected outwards.**



### WARNING

**Due to high voltage, the bulb of (Bi-Xenon) gas-discharge headlights must only be replaced by experts: danger of death! Contact Fiat Dealership.**

**IMPORTANT** The headlight inner surface may be lightly misted over: this is not a fault but a natural fact due to low temperature and the level of air humidity. It will disappear as soon the headlights are turned on. The presence of drops inside the headlights means water infiltration, therefore contact Fiat Dealership.



## TYPES OF BULBS fig. 18

Various types of bulbs are fitted to your car:

- A All glass bulbs:** these are pressed on. Pull to remove.
- B Bayonet type bulbs:** press the bulb, turn counterclockwise to remove this type of bulb from its holder.

**C Tubular bulbs:** free them from their contacts to remove.

**D-E Halogen bulbs:** to remove the bulb, release the clip holding the bulb in place.

**F Gas-discharge bulbs (Bi-Xenon).**

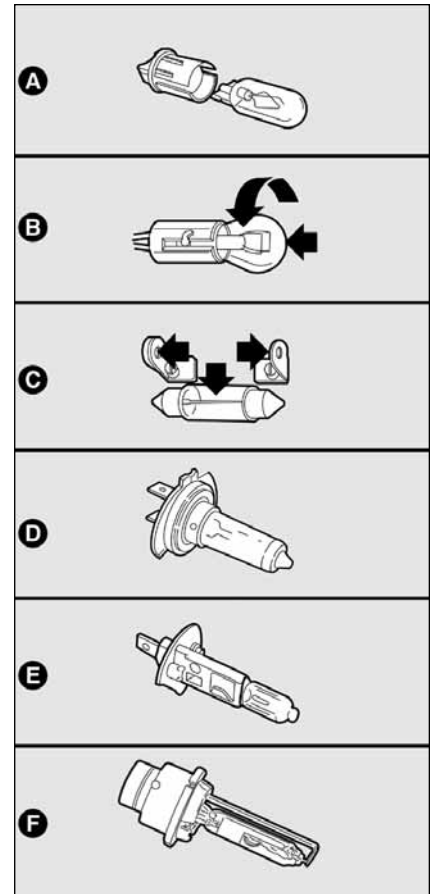

fig. 18

F0Q0391m

<b>Bulbs</b>	<b>Figure 18</b>	<b>Type</b>	<b>Power</b>
Main beam headlights	<b>E</b>	H1	55W
Longlife dipped beam headlights	<b>D</b>	H1	55W
Gas-discharge low beam headlights (where provided)	<b>F</b>	D2R	35W
Front sidelights longlife	<b>A</b>	W5W	5W
Front fog lights (where provided)	<b>E</b>	H11	55W
Front direction indicators	<b>B</b>	PY24W	24W
Side direction indicators	<b>A</b>	WY5W	5W
Rear direction indicators	<b>B</b>	R10W	10W
Taillights/rear fog lights	<b>B</b>	P5/21W	5W/21W
Rear/stop positions	<b>B</b>	P5/21W	5W/21W
Third brake light (additional brake light)	<b>A</b>	W2.3W	2.3W
Reversing light	<b>B</b>	P21W	21W
Number plate light	<b>A</b>	W5W	5W
Front roof light	<b>C</b>	C10W	2x10W
Rear roof light (where provided)	<b>C</b>	C10W	10W
Glovebox light	<b>C</b>	C5W	5W
Boot light	<b>A</b>	W5W	5W
Courtesy mirror light (where provided)	<b>C</b>	C5W	5W

DASHBOARD  
AND CONTROLS

SAFETY  
DEVICES

CORRECT USE  
OF THE CAR

WARNING  
LIGHTS AND  
MESSAGES

IN AN  
EMERGENCY

CAR  
MAINTENANCE

TECHNICAL  
SPECIFICATIONS

INDEX

## IF AN EXTERIOR LIGHT BURNS OUT

For the type of bulb and power rating, see “When needing to change a bulb”.

### FRONT LIGHT UNITS fig. 19

The front light units contain the side/tail-lights, dipped beam, main beam and direction indicator bulbs.

The bulbs are arranged inside the light unit as follows:

**A** Sidelights / main beam headlights;

**B** Dipped beam headlights;

**C** Direction indicators.

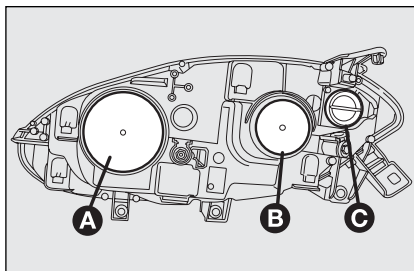

fig. 19

F0Q0704m

### DIPPED BEAM HEADLIGHTS

#### Gas-filled filament lamps

To change the bulb, proceed as follows:

- remove the protective cover **B**-fig. 19;
- release the bulb holder catch **A**-fig. 20;
- disconnect the electric connector **B**;
- remove the bulb **C** and replace it;
- fit the new bulb, making the tabs of the metallic part coincide with the grooves on the reflector, reconnect the electrical connector **B** then hook the bulb holder catch **A**;
- refit the protective cover **A**-fig. 19 correctly.

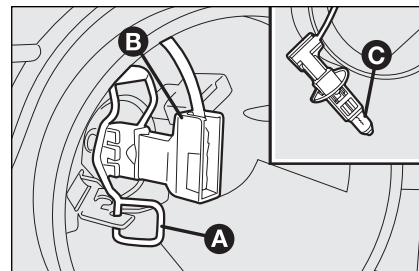

fig. 20

F0Q0705m

### Gas-discharge lamps (Bi-Xenon) (where provided)



#### WARNING

*Due to high voltage, the bulb of (Bi-Xenon) gas-discharge headlights must only be replaced by experts: danger of death! Contact Fiat Dealership.*

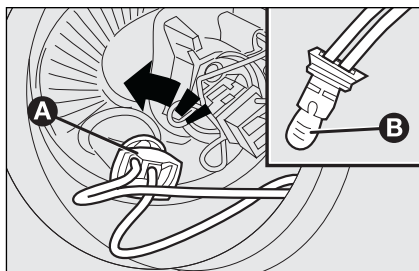

fig. 21

F0Q0706m

## SIDELIGHTS

To change the bulb, proceed as follows:

- remove the protective cover **A-fig. 19**;
- turn the bulb holder **A-fig. 21** counterclockwise and then withdraw it;
- remove the bulb **B** and replace it;
- fit the new bulb, refit the bulb holder **A-fig. 21** and then refit the protective cover **B-fig. 19** correctly.

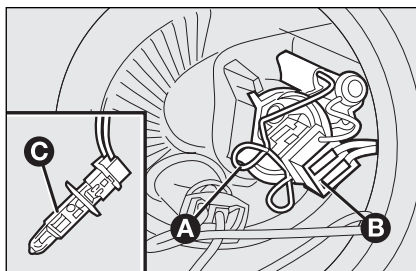

fig. 22

F0Q0707m

## MAIN BEAM HEADLIGHTS

To change the bulb, proceed as follows:

- remove the protective cover **A-fig. 19**;
- release the bulb holder catch **A-fig. 22**;
- remove the bulb **C** and replace it;
- fit the new bulb, making the tabs of the metallic part coincide with the grooves on the reflector, reconnect the electrical connector **B** then hook the bulb holder catch **A**;
- refit the protective cover **B-fig. 19** correctly.

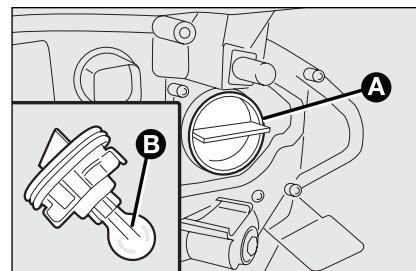

fig. 23

F0Q0708m

## DIRECTION INDICATORS

### Front

To change the bulb, proceed as follows:

- turn the protective cover **C-fig. 19** counterclockwise;
- remove the bulb **B-fig. 23** and replace it;
- refit the protective cover **A** correctly.

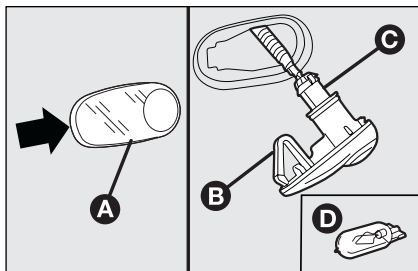

fig. 24

F0Q0709m

**Side**

To change the bulb, proceed as follows:

- push the transparent cover **A**-fig. 24 to compress the internal catch **B**, then remove the unit;
- turn the bulb holder **C** counterclockwise, remove the snap-fitted bulb **D** and replace it;
- refit the bulb holder **C** in the lens by turning it clockwise;
- refit the unit making sure the catch clicks into place **B**.

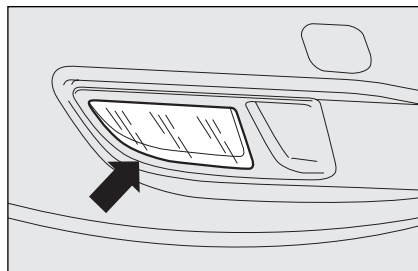

fig. 25

F0Q0710m

**FRONT FOG LIGHTS fig. 25  
(where provided)**

Contact Fiat Dealership to have front fog lights replaced.

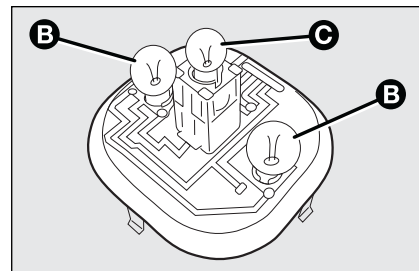

fig. 26

F0Q0714m

**REAR LIGHT UNITS fig. 26**

Rear light units contain taillights, direction indicators and brake light (stop) bulbs.

The bulbs are arranged inside the light unit **fig. 26** as follows:

- B** taillights/brake light (double light);
- C** direction indicators.

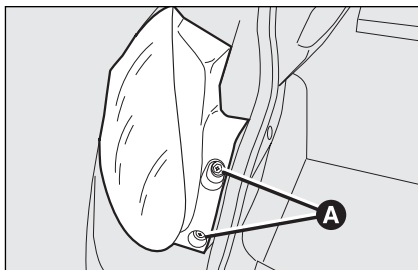

fig. 27

F0Q0715m

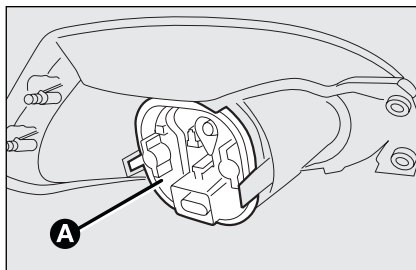

fig. 29

F0Q0713m

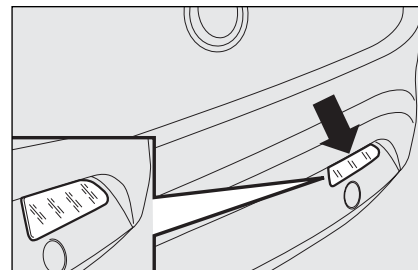

fig. 30

F0Q0711m

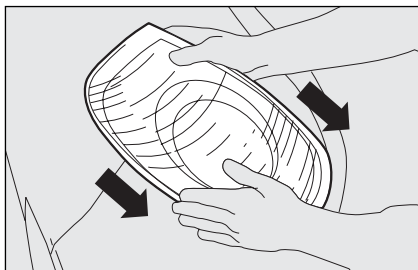

fig. 28

F0Q0739m

### REVERSING LIGHTS fig. 30

Contact Fiat Dealership to have reversing light bulbs replaced.

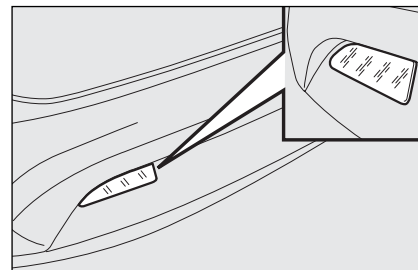

fig. 31

F0Q0712m

### REAR FOG LIGHTS fig. 31

Contact Fiat Dealership to have rear fog light bulbs replaced.

To change the bulb proceed as follows:

- open the tailgate then, slacken the two fastening screws **A-fig. 27**;
- remove the light unit with both hands as shown by the arrows in **fig. 28**;
- disconnect the electric connector and remove the protective cover **A-fig. 29** pressing the three catches and replace the burnt out bulb.

- DASHBOARD AND CONTROLS
- SAFETY DEVICES
- CORRECT USE OF THE CAR
- WARNING LIGHTS AND MESSAGES
- IN AN EMERGENCY
- CAR MAINTENANCE
- TECHNICAL SPECIFICATIONS
- INDEX

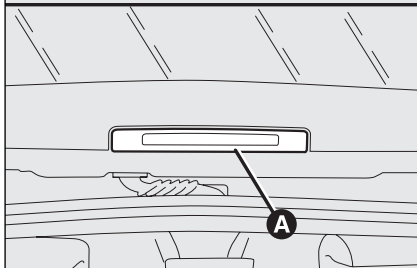
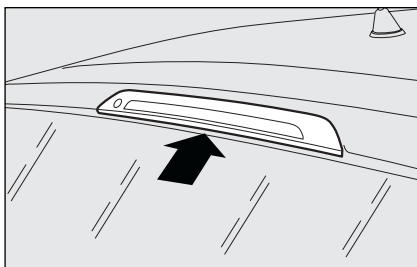

fig. 32

FOQ0716m

### THIRD BRAKE LIGHT

To change the bulb proceed as follows:

- open the tailgate;
- remove cover **A-fig. 32**;
- remove the lens unit **B-fig. 33** and disconnect the electric connector;

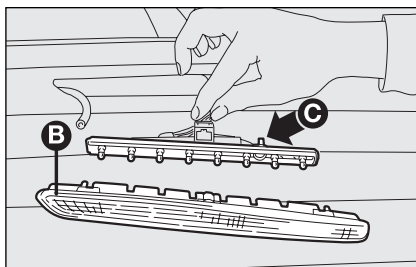

fig. 33

FOQ0751m

- press the tabs **C-fig. 33** and remove the bulb holder;
- remove the snap-fitted bulb and replace it.
- refit cover **A-fig. 32** and then close the tailgate.

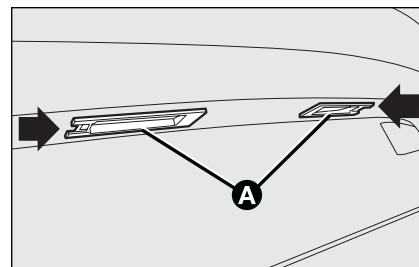

fig. 34

FOQ0718m

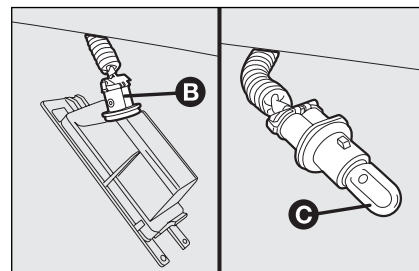

fig. 35

FOQ0719m

### NUMBER PLATE LIGHTS

To change the bulb proceed as follows:

- work in the point shown by the arrow and remove lens unit **A-fig. 34**;
- turn the bulb holder **B-fig. 35** clockwise;
- remove the bulb **C** and replace it.

## IF AN INTERIOR LIGHT BURNS OUT

For the type of bulb and power rating, see “When needing to change a bulb”.

### FRONT CEILING LIGHT

To replace the bulbs proceed as follows:

- work in the points shown by the arrows and remove light **A**-fig. 36;
- open the protection lid **B**-fig. 37;
- replace bulbs **C** releasing them from the side contacts; make sure that new bulbs are correctly clamped between contacts;
- re-close the lid **B**-fig. 37 and secure light **A**-fig. 36 into its housing locking it properly.

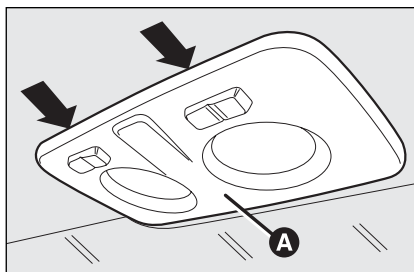

fig. 36

F0Q0720m

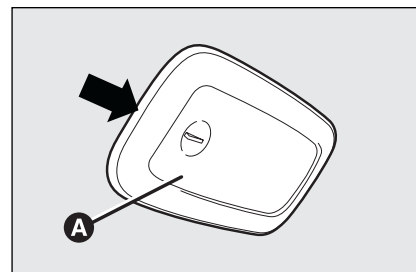

fig. 38

F0Q0723m

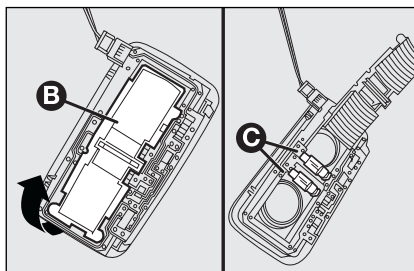

fig. 37

F0Q0721m

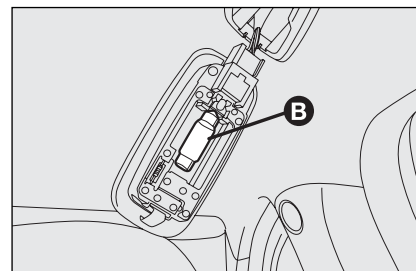

fig. 39

F0Q0722m

### REAR CEILING LIGHT

#### Versions without sunroof

To replace the bulbs proceed as follows:

- remove the light unit **A**-fig. 38 levering in the point shown by the arrow;

- replace the bulb **B**-fig. 39 releasing it from the side contacts making sure that the new bulb is correctly clamped between the contacts.



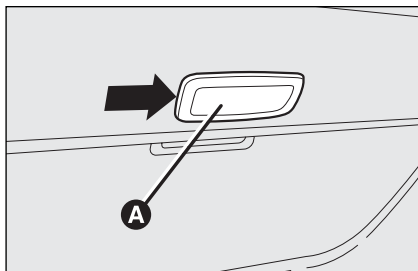

fig. 40

FOQ0741m

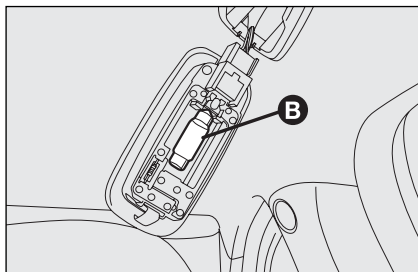

fig. 41

FOQ0722m

### Versions with sunroof

To replace the bulbs proceed as follows:

- remove the light unit **A-fig. 40** levering in the point shown by the arrow;
- replace the bulb **B-fig. 41** releasing it from the side contacts making sure that the new bulb is correctly clamped between the contacts.

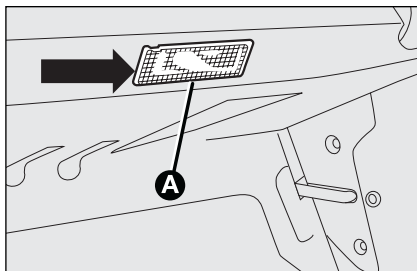

fig. 42

FOQ0724m

### BOOT LIGHT

To change the bulb, proceed as follows:

- open the tailgate;
- remove the light unit **A-fig. 42** levering in the point shown by the arrow;
- open the protection cover **B-fig. 43** and replace the snap-fitted bulb;

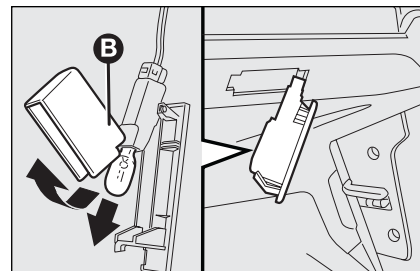

fig. 43

FOQ0725m

- re-close the protective cover **B** on the lens;
- refit the light **A** inserting it in its correct position firstly on one end and then on the other until it clicks into place.

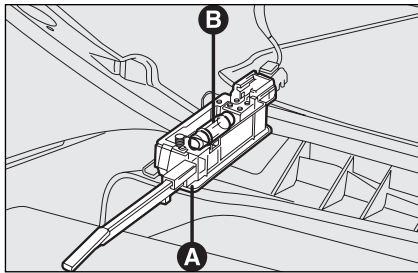

fig. 44

F0Q0726m

### GLOVEBOX LIGHT

To change the bulb, proceed as follows:

- open the glovebox, then remove the light unit **A**-fig. 44;
- replace the bulb **B** releasing it from the side contacts making sure that the new bulb is correctly clamped between the contacts.

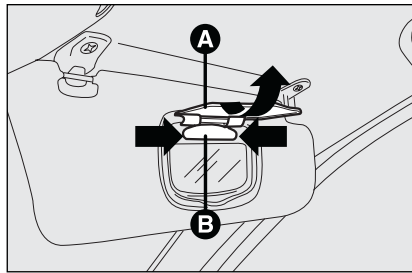

fig. 45

F0Q0423m

### COURTESY MIRROR LIGHT (where provided)

To change the bulb, proceed as follows:

- open the mirror cover **A**-fig. 45;
- remove the bulb **B** levering in the points shown by the arrows;

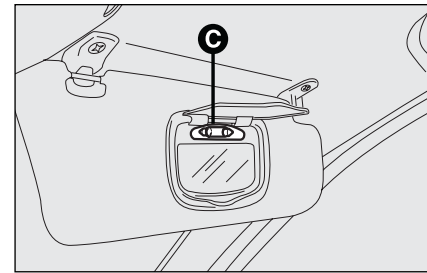

fig. 46

F0Q0424m

- replace the bulb **C**-fig. 46 releasing it from the side contacts making sure that the new bulb is correctly clamped between the contacts.

## IF A FUSE BLOWS

### GENERAL

The fuse is a protective device for the electric system: it comes into action (i.e. it cuts off) mainly due to a fault or improper action on the system.

When a device does not work, check the efficiency of its fuse: the conductor element **A**-fig. 47 must be intact. If not, replace the fuse with one of the same amp rating (same colour).

**B:** undamaged fuse

**C:** fuse with damaged filament.

To replace a fuse, use the pliers **D** hooked to the fusebox on the dashboard.



### WARNING

*If a fuse blows again, contact a Fiat Dealership.*

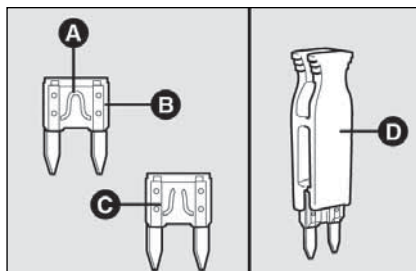

fig. 47

F0Q0220m



*Never replace a fuse with metal wires or anything else.*



### WARNING

*Never replace a fuse with another with a higher amp rating, DANGER OF FIRE.*



### WARNING

*If a general fuse (MEGA-FUSE, MIDI-FUSE, MAXI-FUSE) cuts in, do not attempt any repair and contact a Fiat Dealership.*



*Before replacing a fuse, make sure the ignition key has been removed and that all the other services are switched off and/or disengaged.*

## FUSE LOCATION

The vehicle fuses are grouped in three control units:

- instrument dashboard fuse control unit;
- fuse control unit in engine compartment;
- fuse control unit in luggage compartment;

### Fuse box on the dashboard fig. 49

To gain access to the fuses in the fuse box on the dashboard, loosen the three fastening screw **A**-fig. 48 and remove the cover **B**.

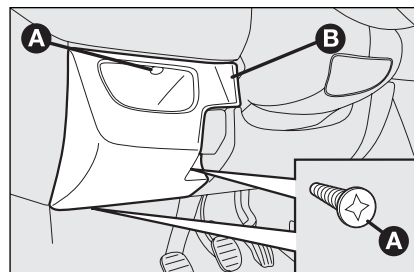

fig. 48

F0Q0727m

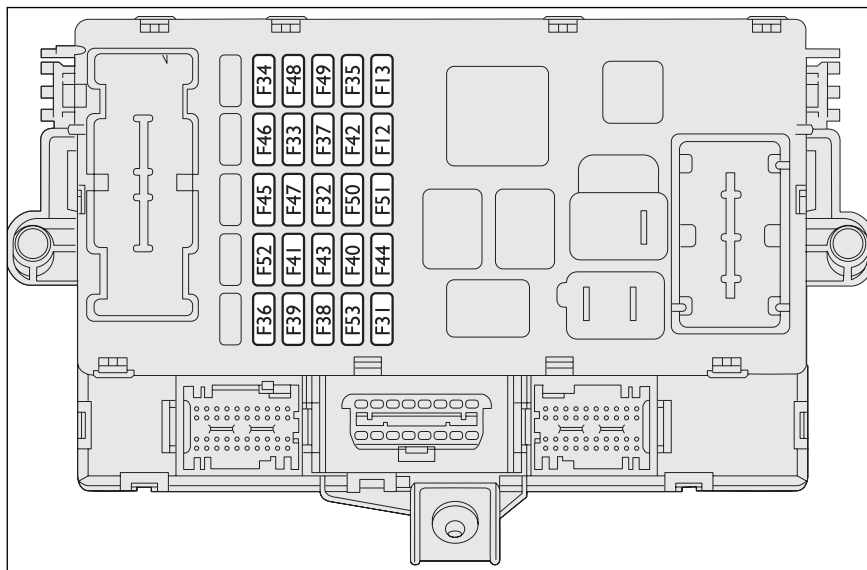

fig. 49

F0Q0266m

DASHBOARD  
AND CONTROLS

SAFETY  
DEVICES

CORRECT USE  
OF THE CAR

WARNING  
LIGHTS AND  
MESSAGES

IN AN  
EMERGENCY

CAR  
MAINTENANCE

TECHNICAL  
SPECIFICATIONS

INDEX

## Fuse box next to the battery fig. 51

To gain access to the fuse box next to the battery, press the retainers **A**-fig. 50 and remove the protection cover **B**.

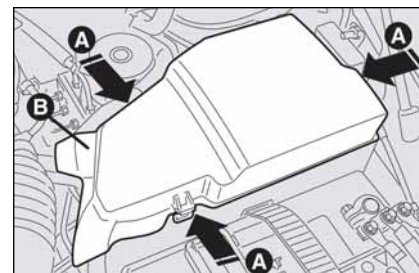

fig. 50

F0Q0498m

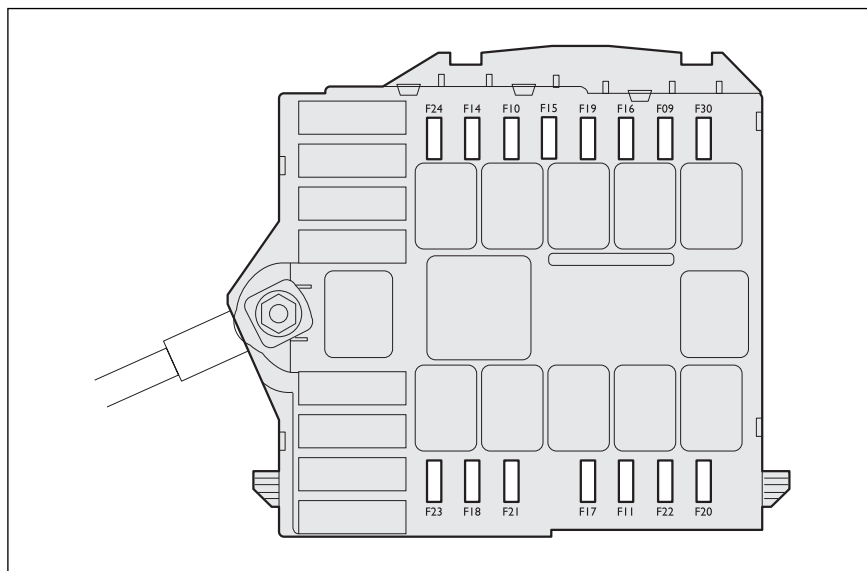

fig. 51

F0Q0026m

## Fuse box in the boot (where provided) fig. 52

To gain access to the fuses in the fuse box on the left side of the boot, open lid **A**-fig. 53.

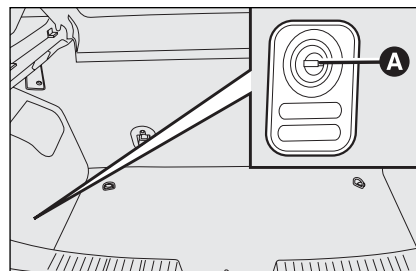

fig. 52

F0Q0747m

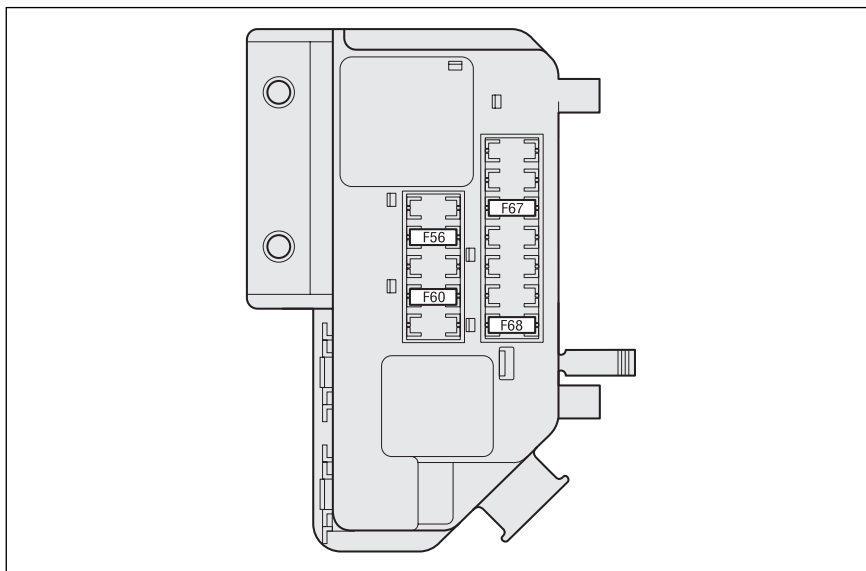

fig. 53

F0Q0744m

DASHBOARD  
AND CONTROLS

SAFETY  
DEVICES

CORRECT USE  
OF THE CAR

WARNING  
LIGHTS AND  
MESSAGES

IN AN  
EMERGENCY

CAR  
MAINTENANCE

TECHNICAL  
SPECIFICATIONS

INDEX

**FUSE SUMMARY TABLE****LIGHTS****FUSE****AMPERE****FIGURE**

Right dipped beam (quartz-iodine headlights)

F12

7.5

49

Right dipped beam (Bi-Xenon headlights)

F12

15

49

Left dipped beam (quartz-iodine headlights)

F13

7.5

49

Left dipped beam (Bi-Xenon headlights)

F13

15

49

Reversing light

F35

7.5

49

Third stop light

F37

7.5

49

Rear fog light (driver's side)

F53

7.5

49

Front fog light/Cornering light, RH

F09

7.5

51

Right main beam headlight

F14

7.5

51

Left main beam headlight

F15

10

51

Front fog light/Cornering light, LH

F30

7.5

51

COMPONENTS	FUSE	AMPERE	FIGURE
Single-tone horn	F10	10	51
Engine diagnosis system secondary loads (lambda sensor, canister solenoid valve, PDA system solenoid valve, EGR solenoid valve, throttle solenoid valve, VGT solenoid valve, glow plug warming control unit)	F11	15	51
Headlamp alignment correction system (versions with gas discharge headlights)	F13	15	49
Headlight alignment correction system (versions with halogen headlights)	F13	7.5	49
Engine control unit (NCM)	F16	7.5	51
Engine control unit (NCM)	F17	10	51
Engine control unit (NCM)	F18	10	51
Conditioner compressor	F19	7.5	51
Headlight washer motor pump	F20	20	51

DASHBOARD  
AND CONTROLS

SAFETY  
DEVICES

CORRECT USE  
OF THE CAR

WARNING  
LIGHTS AND  
MESSAGES

IN AN  
EMERGENCY

CAR  
MAINTENANCE

TECHNICAL  
SPECIFICATIONS

INDEX



COMPONENTS	FUSE	AMPERE	FIGURE
Fuel motor pump on tank	F21	15	51
Engine diagnosis system primary loads (injectors, ignition coils)	F22	15	51
Engine diagnosis system primary loads (injectors, ignition coils, engine control unit for diesel versions)	F22	20	51
Braking system control unit (NFR) (electronic control unit, solenoid valves)	F23	30	51
Electric steering control unit (NGE)	F24	7.5	51
Remote switch coils on fuse box in engine compartment (CVM)/ Body Computer control unit (NBC)	F31	5	49
Hi-Fi system subwoofer	F32	15	49
Rear left power window	F33	20	49
Rear right power window	F34	20	49
Brake pedal control (normally closed contact NC)/ water in diesel fuel sensor/flow meter	F35	5	49

COMPONENTS	FUSE	AMPERE	FIGURE
Door opening system control unit (CGP) (door opening/closing, safe lock, tailgate release)	F36	20	49
Brake pedal control (normally closed contact NA)/ Instrument panel (NQS)/gas-discharge lamp control units on front headlights	F37	7.5	49
Sound system/Sound system presetting/Connect Nav +/Blu&Me System/ Alarm siren (CSA)/Alarm system on ceiling light/Internal cooling unit system/Tyre pressure monitoring control unit (CPP)/Diagnostic socket connector/Rear ceiling lights	F39	10	49
Heated rear window	F40	30	49
Electric door mirror defrosters/Defrosters on front nozzles	F41	7.5	49
Braking system control unit (NFR)/Yaw sensor (YRS)	F42	5	49
Windscreen wiper/Windscreen/rear window washer bidirectional motor pump system on steering column stalk	F43	30	49
Current outlet/Cigar lighter	F44	15	49

DASHBOARD  
AND CONTROLS

SAFETY  
DEVICES

CORRECT USE  
OF THE CAR

WARNING  
LIGHTS AND  
MESSAGES

IN AN  
EMERGENCY

CAR  
MAINTENANCE

TECHNICAL  
SPECIFICATIONS

INDEX

## COMPONENTS

## FUSE

## AMPERE

## FIGURE

Power sunroof motor

F46

20

49

Front power window (left side)

F47

20

49

Front power window (right side)

F48

20

49

Emergency control panel (illumination)/Central right and left branch control panel (illumination, ASR switch)/ Controls on steering wheel (illumination)/Control panel on front ceiling light (illumination)/Volumetric protection alarm system control unit (deactivation)/Power sunroof (control unit, control illumination)/rain sensor/daylight sensor on driving mirror/Front seat warming activation controls

F49

5

49

Air bag control unit (NAB)

F50

7.5

49

Internal cooling unit system/Sound system presetting/ Connect Nav +/Blu&Me system control unit/Parking sensor control unit (NSP)/Air quality sensor (AQS)/Automatic air-conditioner/Electric door mirrors (moving, folding)/ Tyre pressure monitoring control unit (CPP)

F51

5

49

Rear window wiper

F52

15

49

COMPONENTS	FUSE	AMPERE	FIGURE
Instrument panel (NQS)	F53	7.5	49
Left front seat heating/movement	F56	30	53
Right front seat heating/movement	F60	30	53
Left front seat heating/movement	F67	10	53
Right front seat heating/movement	F68	10	53
Free	F38	–	49
Free	F45	–	49

DASHBOARD  
AND CONTROLS

SAFETY  
DEVICES

CORRECT USE  
OF THE CAR

WARNING  
LIGHTS AND  
MESSAGES

IN AN  
EMERGENCY

CAR  
MAINTENANCE

TECHNICAL  
SPECIFICATIONS

INDEX

## IF THE BATTERY IS FLAT

**IMPORTANT** The battery charging procedure is described only for information purposes. This operation should be carried out by Fiat Dealership.

Charging should be slow at a low amp rating for 24 hours. Charging for a longer time may damage the battery.

Charge the battery as follows:

- disconnect battery negative terminal;
- connect the charger cables to the battery terminals, observing the poles;
- turn on the charger;
- when you have finished, turn the charger off before disconnecting the battery;
- reconnect battery negative terminal.

**IMPORTANT** Where relevant, switch the electronic car alarm off with remote control (see “Alarm” in section “Dashboard and controls”).



### WARNING

*The liquid contained in the battery is poisonous and corrosive. Avoid contact with the skin or eyes. The battery should be charged in a well ventilated place, away from naked flames or possible sources of sparks: danger of explosion and fire.*



### WARNING

*Do not attempt to charge a frozen battery: it must first be thawed, otherwise it may burst. If freezing has occurred, the battery should be checked by skilled personnel to make sure that the internal elements are not damaged and that the body is not cracked, with the risk of leaking poisonous and corrosive acid.*

## JACKING THE CAR

If the car is to be lifted, go to a Fiat Dealership which is equipped with the arm hoist or workshop lift.

The car can only be jacked at the sides, jack arms or workshop lift shall be placed as shown in **fig. 54**.

**IMPORTANT** For Sport versions, in case of side lifting with workshop lifter, take care to avoid damages to the spoilers.

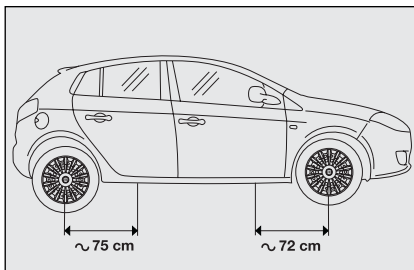

fig. 54

F0Q0729m

## TOWING THE CAR

The tow ring provided with the car is housed in the tool box under the boot mat.

### TOW RING HOOKING

Proceed as follows:

- release the cap operating the tab **A**-**fig. 55-56**;
- take the tow hook **B** from its support;
- tighten the ring on the rear or front threaded pin.

DASHBOARD  
AND CONTROLS

SAFETY  
DEVICES

CORRECT USE  
OF THE CAR

WARNING  
LIGHTS AND  
MESSAGES

IN AN  
EMERGENCY

CAR  
MAINTENANCE

TECHNICAL  
SPECIFICATIONS

INDEX

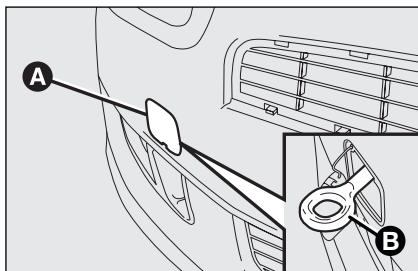

fig. 55

FOQ0730m

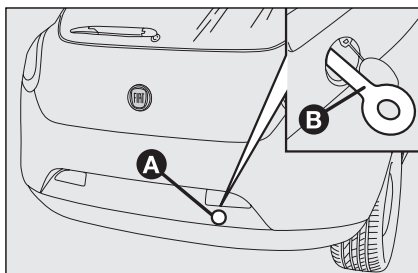

fig. 56

FOQ0731m

**WARNING**

Before starting to tow, turn the ignition key to **MAR** and then to **STOP**. Do not remove the key. If the key is removed, the steering lock engages automatically resulting in the impossibility to steer the wheels.

**WARNING**

Do not start the engine when towing the car.

**WARNING**

Before fitting the hook, clean accurately its threaded seat. Before starting to tow, make sure to have tighten the hook.

**WARNING**

When towing, remember that without the help of the servobrake and power steering, a greater effort is required on the pedal and steering wheel. Do not use flexible cables for towing and avoid jerks. During towing operations make sure that fastening the joint to the car does not damage the components in contact with it. When towing the car, you must comply with the specific traffic regulations regarding the tow ring and how to tow on the road.

# CAR MAINTENANCE

SCHEDULED SERVICING .....	192
SERVICE SCHEDULE.....	193
ROUTINE MAINTENANCE .....	195
HEAVY-DUTY .....	195
CHECKING FLUID LEVELS.....	196
AIR CLEANER/POLLEN FILTER .....	201
BATTERY .....	202
WHEELS AND TYRES .....	204
RUBBER HOSES.....	205
WINDSCREEN/REAR WINDOW WIPERS.....	206
BODYWORK .....	208
INTERIORS .....	210

DASHBOARD  
AND CONTROLS

SAFETY  
DEVICES

CORRECT USE  
OF THE CAR

WARNING  
LIGHTS AND  
MESSAGES

IN AN  
EMERGENCY

CAR  
MAINTENANCE

TECHNICAL  
SPECIFICATIONS

INDEX



## SCHEDULED SERVICING

Correct maintenance is essential for ensuring long car life under the best conditions.

This is why Fiat has programmed a series of checks and maintenance operations every 30.000 km.

It is however important to remember that scheduled servicing does not completely cover all the car's requirements: also in the initial period before 30.000 km service coupon and later, between one coupon and another, ordinary care is still required such as for example routine check and topping up the level of fluids, tyre pressure check, etc...

**IMPORTANT** The Programmed Maintenance coupons are specified by the Manufacturer. The failure to have them carried out may invalidate the warranty.

Scheduled Servicing is performed by all Fiat Dealership, at pre-established times.

If during each operation, in addition to the ones programmed, the need arises for further replacements or repairs, these may be carried out only with the explicit agreement of the Customer.

**IMPORTANT** You are advised to contact Fiat Dealership in the event of any minor operating faults, without waiting for the next service coupon.

If your car is used frequently for towing, the interval between one service coupon and the other must be reduced.

# SERVICE SCHEDULE

Thousands of km	30	60	90	120	150	180
Check tyre conditions/wear and adjust pressure if necessary	●	●	●	●	●	●
Check lighting system operation (headlights, direction indicators, hazard lights, luggage compartment lights, passenger compartment lights, glove compartment lights, instrument panel warning lights, etc.)	●	●	●	●	●	●
Check operation of windscreen wiper system and adjust sprays if necessary	●	●	●	●	●	●
Check position/wear of front/rear windscreen wiper blades	●	●	●	●	●	●
Check condition and wear of front disc brake pads and operation of pad wear indicator	●	●	●	●	●	●
Check conditions and wear of rear disc brake pads		●		●		●
Visually check that the following are in good condition and intact: body exterior, under body protection, pipe rigid and flexible sections (exhaust-fuel system-brakes), rubber parts (gaiters, sleeves, bushes, etc.)	●	●	●	●	●	●
Check cleanliness of locks, bonnet, engine and boot, clean and lubricate linkages	●	●	●	●	●	●
Check and top-up fluids (hydraulic brakes/clutch, windscreen washer, battery, engine coolant, etc.)	●	●	●	●	●	●
Check and adjust handbrake lever travel	●		●		●	
Check visually conditions of auxiliary drive belt/s		●				●
Visually check conditions of toothed timing belt (1.4 16V, 1.4 T-JET, 1.9 Multijet 8V versions)		●				●
Check tension and adjust auxiliary drive belt (except for engines with automatic tensioners)	●				●	
Check and adjust tappet clearance (1.9 Multijet 8V version)		●		●		●

DASHBOARD AND CONTROLS

SAFETY DEVICES

CORRECT USE OF THE CAR

WARNING LIGHTS AND MESSAGES

IN AN EMERGENCY

CAR MAINTENANCE

TECHNICAL SPECIFICATIONS

INDEX

	Thousands of km	30	60	90	120	150	180
DASHBOARD AND CONTROLS	Check exhaust emissions (petrol versions)	●	●	●	●	●	●
	Check emissions/fumes (diesel versions)	●	●	●	●	●	●
	Check evaporation control system (petrol versions)			●			●
SAFETY DEVICES	Check operation of engine control systems (by means of test interface)	●	●	●	●	●	●
	Replace accessory drive belt/s				●		
CORRECT USE OF THE CAR	Replace toothed timing belt (petrol versions) (*)				●		
	Replace toothed timing belt (1.9 Multijet 8V versions) (*)				●		
	Replace toothed timing belt (1.9 Multijet 16V versions) (*)					●	
WARNING LIGHTS AND MESSAGES	Replace spark plugs (petrol versions) ▲	●	●	●	●	●	●
	Replace fuel filter (diesel versions)		●		●		●
	Replace air filter cartridge (petrol versions)		●		●		●
	Replace air filter cartridge (diesel versions)		●		●		●
IN AN EMERGENCY	Replace engine oil and oil filter (petrol versions) (or every 24 months) ▲	●	●	●	●	●	●
	Change engine oil and oil filter (diesel versions without DPF) (or every 24 months)	●	●	●	●	●	●
CAR MAINTENANCE	Change engine oil and oil filter (diesel versions with DPF) (**)						
	Change brake fluid (or every 24 months)		●		●		●
TECHNICAL SPECIFICATIONS	Change pollen filter (or every 12 months)	●	●	●	●	●	●

(\*) Irrespective of mileage, the timing drive belt must be replaced every 4 years for heavy duty applications, cold climates, town use, long periods idling) or at least every 5 years.

(\*\*) The engine oil and oil filter should be changed depending on their actual condition, which is indicated by a warning light/message on the control panel or at least every 2 years.

▲ For 1.4 T-JET 150 HP version, in order to ensure correct operation and avoid significant damages to the engine, it is mandatory:

- to use spark plugs specifically certified for the T-JET engine only, of the same type and brand (see paragraph "Engine");
- to replace the plugs as often as required by the Programmed Maintenance Plan;
- we recommend to refer to the Fiat Dealership.

▲ If the car is used mainly on urban routes or if the yearly kilometres travelled are less than 10,000 km, the engine oil and filter must be changed every 12 months.

## ROUTINE MAINTENANCE

Every 1,000 km or before long journeys, check and top up if required:

- engine coolant fluid level;
- brake fluid level;
- windscreen washer fluid level;
- tyre pressure and conditions;
- light system operation (headlights, direction indicators, hazard lights, etc.);
- windscreen wiper/washer operation and windscreen/rear window blade position/wear;

Every 3,000 km check and top up if required: engine oil level.

You are recommended to use **FL Selenia**, products, designed and produced specifically for Fiat cars (see table “Capacities” in section “Technical specifications”).

## HEAVY-DUTY

Should prevailing use of the car be under one of the following specially heavy conditions:

- trailer or caravan towing;
- dusty roads;
- short distances (less than 7-8 km) repeated and with external temperatures below zero;
- frequently idling engines or long distance low speed driving (e.g. door-to-door deliveries) or in case of a long term inactivity;
- driving in the city;

carry out the following checks more frequently than required in the Service Schedule:

- check front disk brake pad conditions and wear;

- check cleanness of locks, bonnet and boot and lever cleanness and lubrication;
- sight inspect the conditions of: engine, gearbox, transmission, pipes and hoses (exhaust - fuel - brakes), rubber parts (boots, sleeves, bushes, etc.);
- check battery charge and fluid level (electrolyte) (only to be carried out by skilled personnel or at Fiat Dealership – see also paragraph “Battery” in this section);
- visual check on various drive belt conditions;
- check and replace pollen filter, if required;
- check and replace air cleaner, if required.

DASHBOARD  
AND CONTROLS

SAFETY  
DEVICES

CORRECT USE  
OF THE CAR

WARNING  
LIGHTS AND  
MESSAGES

IN AN  
EMERGENCY

CAR  
MAINTENANCE

TECHNICAL  
SPECIFICATIONS

INDEX

## CHECKING FLUID LEVELS



When topping up take care not to confuse the various types of fluids: they are all incompatible with one another and could seriously damage the car.



### WARNING

Never smoke while working in the engine compartment; gas and inflammable vapours may be present, with the risk of fire.

1 Engine oil - 2 Battery - 3 Brake fluid  
4 Windscreen/rear window/headlight washer fluid - 5 Engine coolant

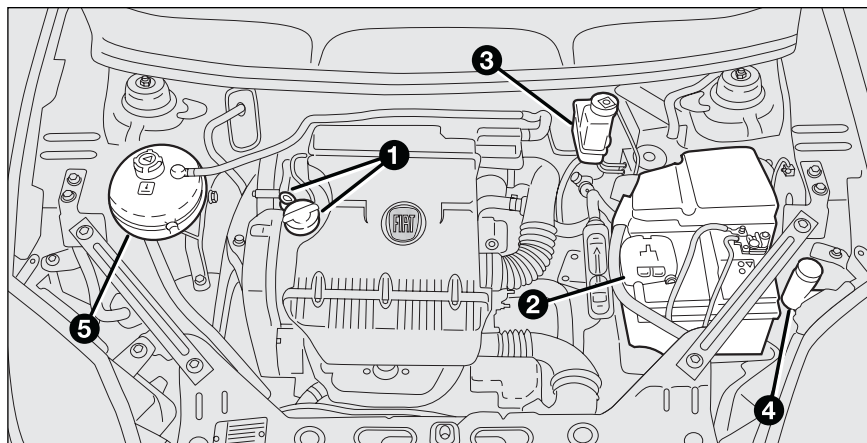

fig. 1 - 1.4 16V version

F0Q0616m

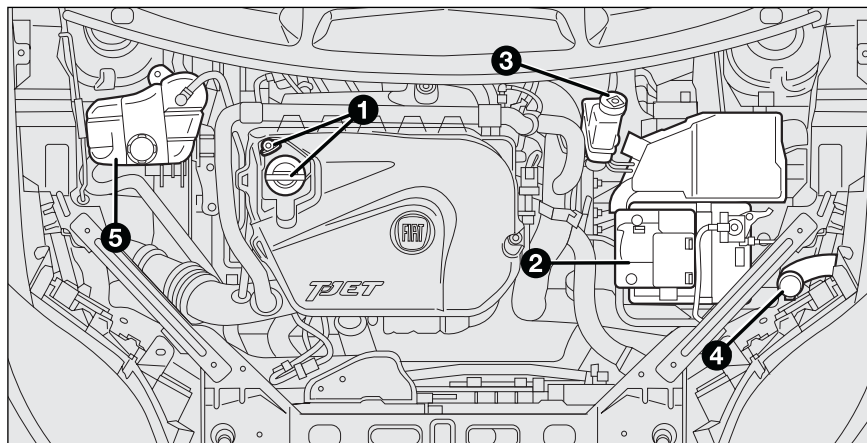

fig. 2 - 1.4 T-JET version

F0Q0024m

1 Engine oil - 2 Battery - 3 Brake fluid  
4 Windscreen/rear window/headlight washer fluid - 5 Engine coolant

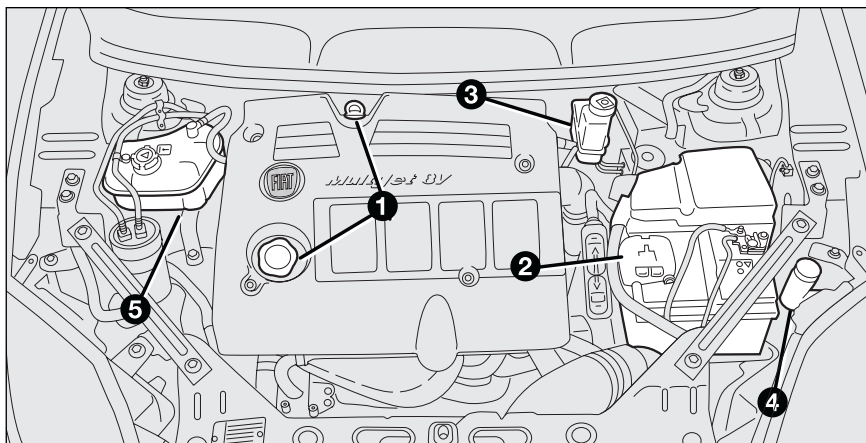

fig. 3 - 1.9 Multijet 8V version

F0Q0615m

1 Engine oil - 2 Battery - 3 Brake fluid  
4 Windscreen/rear window/headlight washer fluid - 5 Engine coolant

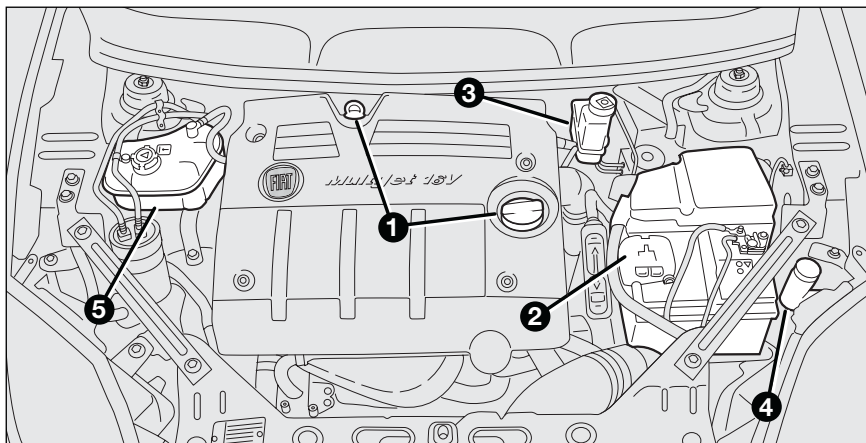

fig. 4 - 1.9 Multijet 16V version

F0Q0618m

DASHBOARD  
AND CONTROLS

SAFETY  
DEVICES

CORRECT USE  
OF THE CAR

WARNING  
LIGHTS AND  
MESSAGES

IN AN  
EMERGENCY

CAR  
MAINTENANCE

TECHNICAL  
SPECIFICATIONS

INDEX

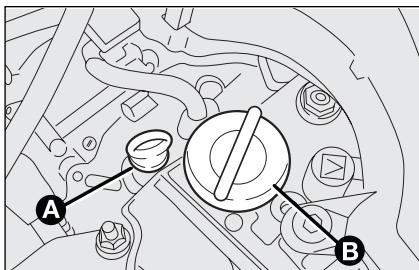

fig. 5 - 1.4 16V version

FOQ0665m

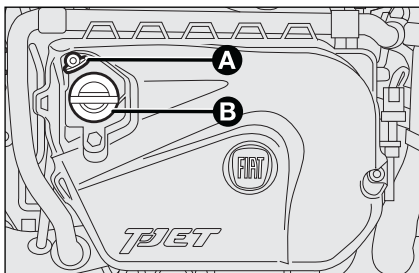

fig. 6 - 1.4 T-JET version

FOQ0025m

## ENGINE OIL fig. 5-6-7-8

### Checking engine oil

Check the oil level a few minutes (about 5) after the engine has stopped, with the car parked on level ground.

Remove the dipstick **A** and clean it, put it back in completely, remove it and check that the level is within the **MIN** and **MAX** marks on the dipstick. The interval between the **MIN** and **MAX** marks corresponds to about one litre of oil.

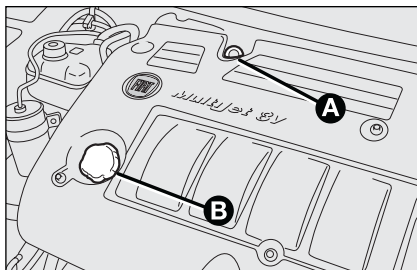

fig. 7 - 1.9 Multijet 8V version

FOQ0620m

### Topping up engine oil

If the oil level is near or even below the **MIN** mark, add oil through the filler neck **B**, until reaching the **MAX** mark.

Oil level shall never exceed the **MAX** mark.

**IMPORTANT** If a routine check reveals that the oil level is above the **MAX** mark, contact Fiat Dealership to have the correct level restored.

**IMPORTANT** After adding or changing the oil, let the engine turn over for a few seconds and wait a few minutes after turning it off before you check the level.

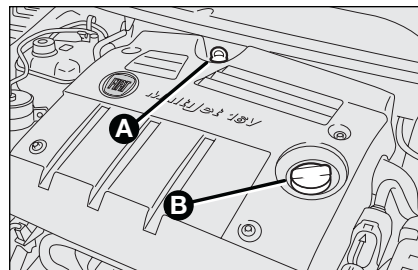

fig. 8 - 1.9 Multijet 16V version

FOQ0621m

### Engine oil consumption

Max engine oil consumption is usually 400 grams every 1000 km.

When the car is new, the engine needs to run in, therefore the engine oil consumption can only be considered stabilised after the first 5000 - 6000 km.

**IMPORTANT** The oil consumption depends on driving style and the conditions under which the car is used.

**IMPORTANT** Do not add oil with specifications other than that already in the engine.



## WARNING

When the engine is hot, take care when working inside the engine compartment to avoid burns. Remember that when the engine is hot, the fan may cut in: danger of injury. Scarves, ties and other loose clothing might be pulled by moving parts.

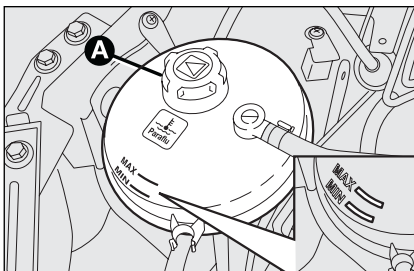

fig. 9 - 1.4 16V version

F0Q0617m

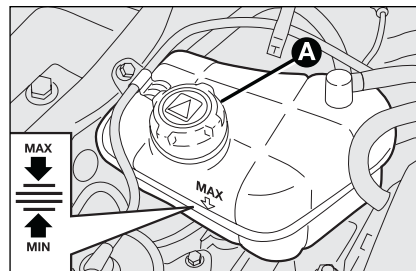

fig. 10 - 1.4 T-JET and 1.9 Multijet version

F0Q0619m

## ENGINE COOLANT FLUID

### fig. 9-10

The coolant level shall be checked with cold engine and shall not be lower than the **MIN** mark on the reservoir.

If the level is low, pour slowly a mixture of 50% distilled water and 50% **PARAFLU<sup>UP</sup>** of the **FL Selenia** through the filler neck **A**.

A 50-50 mixture of **PARAFLU<sup>UP</sup>** and distilled water gives freeze protection to  $-35^{\circ}\text{C}$ .

For particularly hard climate conditions, we recommend use of a 60% **PARAFLU<sup>UP</sup>** and 40% demineralized water mixture.



The cooling system uses **PARAFLU<sup>UP</sup>** antifreeze. Do not add fluid having different specifications from that already existing. **PARAFLU<sup>UP</sup>** cannot be mixed with other types of fluids. Should other fluids be added, do not start the engine and contact Fiat Dealership as soon as possible.



## WARNING

Do not remove the reservoir cap when the engine is hot: you risk scalding yourself. The cooling system is pressurised. If necessary, replace the cap only with another genuine one, otherwise system efficiency could be compromised.



Used engine oil and filter contain harmful substances for the environment. Contact Fiat Dealership to have the oil and filter changed.



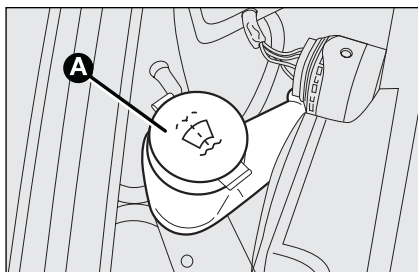

fig. 11

F0Q0666m

## WINDSCREEN/REAR WINDOW/HEADLIGHT WASHER FLUID fig. 11

To top up, open the cap **A** and then pour a mixture of water and **TUTELA PROFESSIONAL SC 35**, in the following concentrations:

- 30% **TUTELA PROFESSIONAL SC 35** and 70% water in summer;
- 50% di **TUTELA PROFESSIONAL SC 35** and 50% water in winter.

In case of temperatures below  $-20^{\circ}\text{C}$ , use undiluted **TUTELA PROFESSIONAL SC 35** fluid.

Check level through the reservoir.

For versions fitted with headlight washer, remove the filter and the relevant dipstick. Use the dipstick to check the fluid level inside the reservoir.



### WARNING

*Do not travel with the windscreen washer reservoir empty. The windscreen washer is fundamental for improving visibility.*



### WARNING

*Certain commercial additives for windscreen washers are inflammable. The engine compartment contains hot components which may set it on fire.*

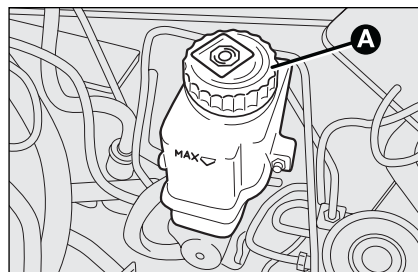

fig. 12

F0Q0664m

## BRAKE FLUID fig. 12

Unscrew cap **A** and check that the fluid level in the reservoir is at maximum.

Fluid level in the reservoir shall not exceed the **MAX** mark.

If fluid has to be added, it is suggested to use the brake fluid in table “Fluids and lubricants” (see chapter “Technical specifications”). When opening cap **A** take the utmost care to prevent impurities entering the tank.

For topping up, always use a funnel with integrated filter with mesh equal to or lower than 0.12 mm.

**IMPORTANT** Brake fluid absorbs moisture. For this reason, if the car is mainly used in areas with a high degree of atmospheric humidity, the fluid should be replaced at more frequent intervals than specified in the "Service schedule".



water.

**Make sure that the highly corrosive brake fluid does not drip onto the paintwork; if it does, wash it off immediately with**



### **WARNING**

**Brake fluid is poisonous and highly corrosive. In the event of accidental contact, wash the parts involved immediately with neutral soap and water, then rinse thoroughly. Call the doctor immediately if the fluid is swallowed.**



### **WARNING**

**Symbol , on the container indicates synthetic brake fluid, distinguishing it from the mineral kind. Using mineral fluids irreversibly damages the special braking system rubber seals.**

## **AIR CLEANER/ POLLEN FILTER**

Air cleaner or pollen filter replacement shall be carried out at Fiat Dealership.

DASHBOARD  
AND CONTROLS

SAFETY  
DEVICES

CORRECT USE  
OF THE CAR

WARNING  
LIGHTS AND  
MESSAGES

IN AN  
EMERGENCY

**CAR  
MAINTENANCE**

TECHNICAL  
SPECIFICATIONS

INDEX

## BATTERY

The battery is of the “Limited maintenance” type: under normal conditions of use the electrolyte does not need topping up with distilled water.

However, to make sure that it is in efficient conditions at routine intervals have it checked at Fiat Dealership only.



### WARNING

*The liquid in the battery is poisonous and corrosive. Avoid contact with eyes and skin. Do not bring naked flames or possible sources of sparks near to the battery: risk of fire and explosion.*



### WARNING

*Running the battery with low fluid level can damage the battery beyond repair and could also cause its explosion.*

## REPLACING THE BATTERY

If required, replace the battery with a genuine spare part having the same specifications.

If a battery with different specifications is fitted, the service intervals given in the “Service schedule” in this section will no longer be valid.

Refer to the instructions provided by the battery manufacturer.



*Incorrect fitting of electrical and electronic accessories can seriously damage the car. If after buying the car, you want to install electric accessories which require permanent electric supply (alarm, free-hand phone kit, etc.) contact Fiat Dealership whose qualified personnel, in addition to suggesting the most suitable devices, will evaluate the overall electric absorption, checking whether the car electric system is capable of withstanding the load required, or whether it should be integrated with a more powerful battery.*



*Batteries contain substances that are very harmful for the environment. You are advised to have the battery changed at a Fiat Dealership, which is properly equipped for disposing of used batteries respecting nature and the law.*



### WARNING

*If the car is left inactive for long periods at cold, remove the battery and store it in a warm place to prevent freezing.*



### WARNING

*When working on the battery or near it, always wear the proper goggles.*

## USEFUL ADVICE FOR LENGTHENING THE LIFE OF YOUR BATTERY

To avoid draining your battery and lengthen its life, observe the following indications:

- when you park the car, ensure the doors, tailgate and bonnet are closed properly;
- the ceiling lights must be off. The car is however provided with an automatic system for switching off internal lights;
- do not keep accessories (e.g.: sound system, hazard lights, etc.) switched on for a long time when the engine is not running;
- before performing any operation on the electrical system, disconnect the battery negative cable;
- battery terminals shall always be perfectly tightened.

Moreover, this might lead to a higher risk of the battery electrolyte freezing (this may even occur at  $-10^{\circ}\text{C}$ ). If the car is inactive for a long period of time, refer to “Car inactivity”, in section “Correct use of the car”.

If after buying the car, you want to install electric accessories which require permanent electric supply (alarm, etc.) contact Fiat Dealership whose qualified personnel, in addition to suggesting the most suitable devices, will evaluate the overall electric absorption, checking whether the car’s electric system is capable of withstanding the load required, or whether it should be integrated with a more powerful battery.

In fact, since these devices continue absorbing energy even when the ignition key is off, they gradually run down the battery.

## WHEELS AND TYRES

Check the pressure of each tyre, including the spare, every two weeks and before long journeys. The pressure should be checked with the tyre rested and cold.

For the correct tyre inflation pressure, see "Wheels" in "Technical specifications" section.

Incorrect pressure causes abnormal tyre wear **fig. 13**:

**A:** normal pressure: tread evenly worn.

**B:** low pressure: tread particularly worn at the edges.

**C:** high pressure: tread particularly worn in the centre.

Tyres must be replaced when the tread wears down to 1.6 mm. In any case, comply with the laws in the country where the car is being driven.

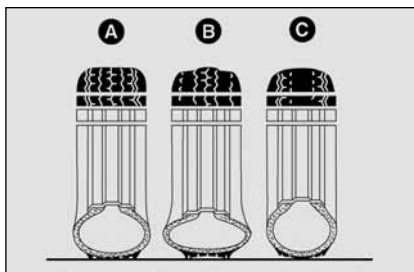

fig. 13

F0Q0101m

### IMPORTANT NOTES

- As far as possible, avoid sharp braking and screech starts, etc. Be careful not to hit the kerb, potholes or other obstacles hard. Driving for long stretches over bumpy roads can damage the tyres;
- Periodically check that the tyres have no cuts in the side wall, abnormal swelling or irregular tyre wear. If any of these occur, have the car seen to at a Fiat Dealership;
- avoid overloading the car when travelling: this may cause serious damage to the wheels and tyres;

- if a tyre is punctured, stop immediately and change it to avoid damage to the tyre, the rim, suspensions and steering system;
- Tyres age even if they are not used much. Cracks in the tread rubber are a sign of ageing. In any case, if the tyres have been on the car for over 6 years, they should be checked by specialised personnel, to see if they can still be used. Also remember to check the space-saver spare wheel;
- In the case of replacement, always fit new tyres, avoiding those of dubious origin;
- If a tyre is changed, also change the inflation valve;
- To allow even wear between the front and rear tyres, it is advisable to change them over every 10-15 thousand kilometres, keeping them on the same side of the car so as to not reverse the direction of rotation.



### WARNING

*Remember that road holding depends also on the correct tyre inflating pressure.*



### WARNING

*If the pressure is too low the tyre overheats and this can cause it serious damage.*



### WARNING

*Do not cross switch the tyres, moving them from the right of the car to the left and vice versa.*



### WARNING

*Never submit alloy rims to repainting treatments requiring to use temperatures exceeding 150°C since the mechanical properties of the wheels could be impaired.*

## RUBBER HOSES

As far as the brake system and fuel rubber hoses are concerned, carefully follow the “Service schedule” in this section.

Indeed ozone, high temperatures and prolonged lack of fluid in the system may cause hardening and cracking of the hoses, with possible leaks. Careful control is therefore necessary.

## WINDSCREEN/ REAR WINDOW WIPERS

### BLADES

Periodically clean the rubber part using special products; **TUTELA PROFESSIONAL SC 35** is recommended.

Change the blades if the rubber edge is warped or worn out. You should in any case change them approximately once a year.

A few simple notions can reduce the possibility of damage to the blades:

- if the temperature fall below zero, make sure that ice has not frozen the rubber against glass. If necessary, thaw using an antifreeze product;
- remove any snow from the glass: in addition to protecting the blades, this prevents effort on the motor and overheating;
- do not operate the windscreen and rear window wipers on dry glass.



#### WARNING

*Driving with worn wiper blades is a serious hazard, because visibility is reduced in bad weather.*

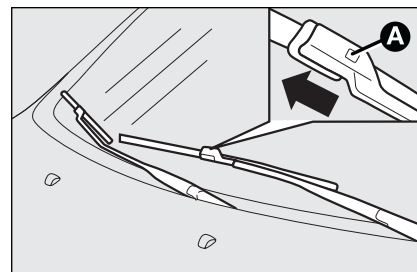

fig. 14

F0Q0662m

### Changing the windscreen wiper blades

Proceed as follows:

- raise the windscreen wiper arm and position the blade so that it forms an angle of 90° with the arm;
- press tab **A-fig. 14** of the coupling spring and remove the blade to be replaced from the arm;
- fit the new arm, inserting the tab into the arm seat. Check for proper locking.

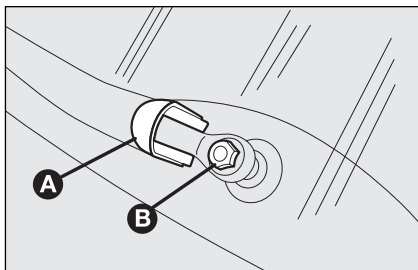

fig. 15

F0Q0663m

### Changing the rear window blade

Proceed as follows:

- raise the cover **A-fig. 15** and remove the arm from the car, slackening the nut **B** that fastens it to the pivot pin;
- fit the new arm, positioning it correctly, and fully tighten the nut;
- lower the cover.

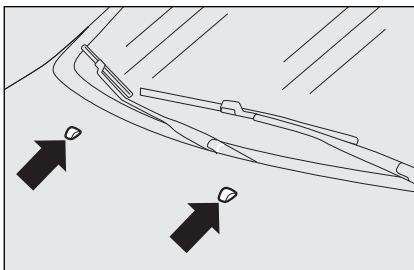

fig. 16

F0Q0661m

### SPRAY NOZZLES

#### Windscreen wiper fig. 16

If the jet of fluid is inadequate, firstly check that there is fluid in the reservoir: see “Checking fluid levels” in this section).

Then check that the nozzle holes are not clogged, if necessary use a needle.

The windscreen jets are fixed.

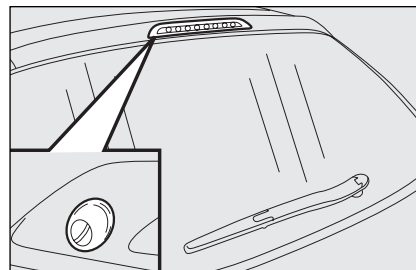

fig. 17

F0Q0660m

#### Rear window wiper fig. 17

Rear window washer jets are fixed.

The nozzle holder is on the rear window.



## BODYWORK

### PROTECTION FROM ATMOSPHERIC AGENTS

The main causes of corrosion are the following:

- atmospheric pollution;
- salty air and humidity (coastal areas, or hot humid climates);
- seasonal environment conditions.

Not to be underestimated is also the abrasive action of wind-borne atmospheric dust and sand and mud and gravel raised by other cars.

On your Fiat Bravo, Fiat implemented the best manufacturing technologies to effectively protect the bodywork against corrosion.

These include:

- Painting products and systems which give the car particular resistance to corrosion and abrasion;
- Use of galvanised (or pretreated) steel sheets, with high resistance to corrosion;
- Spraying the underbody, engine compartment, wheelhouse internal parts and other parts with highly protective wax products;
- Spraying of plastic parts, with a protective function, in the more exposed points: underdoor, inner fender parts, edges, etc.;
- Use of “open” boxed sections to prevent condensation and pockets of moisture from triggering rust inside.

### BODY AND UNDERBODY WARRANTY

Your car is covered by warranty against perforation due to rust of any original element of the structure or body. For the general terms of this warranty, refer to the Fiat Warranty booklet.

## ADVICE FOR PRESERVING THE BODYWORK

### Paint

Paintwork does not only serve an aesthetic purpose, but also protects the underlying sheet metal.

In the case of deep scrapes or scores, you are advised to have the necessary touching up carried out immediately to avoid the formation of rust. Use only original paint products for touching up (see “Bodywork paint identification plate” in section “Technical specification”).

Normal paint maintenance consists in washing at intervals depending on the conditions and environment of use. For example, in highly polluted areas, or if the roads are sprayed with salt, it is wise to wash the car more frequently.

To wash the car correctly proceed as follows:

- remove the aerial from the roof to prevent damage to it if the car is washed in an automatic system;
- wash the body using a low pressure jet of water;
- wipe a sponge with a slightly soapy solution over the bodywork, frequently rinsing with the sponge;
- rinse well with water and dry with a jet of air or a chamois leather.

When drying, take particular care with the less visible parts like door surrounds, bonnet and around the headlights where water may stagnate. The car should not be taken to a closed area immediately, but left in the open so that residual water can evaporate.

Do not wash the car after it has been left in the sun or with the bonnet hot: this may alter the shine of the paintwork.



**Detergents cause water pollution. Therefore the car should be washed in areas equipped for collecting and purifying the liquid used in the washing process.**

Exterior plastic parts must be cleaned in the same way as the rest of the car.

Where possible, do not park under trees; the resinous substance many species release give the paint a dull appearance and increase the possibility of triggering rust processes.

**IMPORTANT** Bird droppings must be washed off immediately and thoroughly as the acid they contain is particularly aggressive.

## Front headlights

**IMPORTANT** Never use aromatic substances (e.g.: petrol) or ketones (e.g.: acetone) for cleaning front headlight plastic lens.

## Windows

Use specific window cleaner product. Use also clean cloths to avoid scratching the glass or damaging the transparency.

**IMPORTANT** The inside of the rearscreen should be wiped gently with a cloth in the direction of the filaments to avoid damaging the heating device.

## Engine compartment

At the end of the winter the engine compartment should be carefully washed, without directing the jet against electronic control units. Contact a specialised workshop to have this done.

**IMPORTANT** The car should be washed with the engine cold and the ignition key at **STOP**. After washing make sure that the various protections (e.g. rubber caps and various covers) have not been damaged or removed.

# INTERIORS

Periodically check that water is not trapped under the mats (due to water dripping off shoes, umbrellas, etc.) which could cause oxidation of the sheet metal.

## CLEANING SEATS AND FABRIC AND VELVET PARTS

Use a soft brush or vacuum cleaner to remove dust. Velvet is cleaned better if the brush is moistened.

Rub the seats with a sponge moistened with a solution of water and neutral detergent.

## CLEANING LEATHER SEATS

Remove dried on dirt with lightly moistened chamois leather or cloth without pressing too hard.

Remove liquid or grease stains with a dry absorbent cloth without rubbing. Then wipe with a soft cloth or chamois leather with water and neutral soap.

If the stain persists, use specific products, carefully following the instructions for use.

**IMPORTANT** Never use spirit or alcohol-based products.



***Fabric upholstery of your car is purpose-made to withstand common wear resulting from normal use of the car. It is however absolutely necessary to prevent hard and/or prolonged scratching/scraping caused by clothing accessories like metallic buckles, studs, “Velcro” fixings, etc. that stressing locally the fabric could break yarns and damage the upholstery as a consequence.***

## INTERIOR PLASTIC PARTS

For routine cleaning of interior plastic parts use a soft cloth moistened with water and neutral soap. Remove grease or persisting stains using appropriate solvent-free products designed to preserve appearance and colour of plastic components.

**IMPORTANT** Never use spirit or petroleum to clean the instrument panel.



### WARNING

***Never use flammable products like oil ether or rectified petrol for cleaning car interiors. Electrostatic discharges generated by rubbing during cleaning operations could cause fire.***

DASHBOARD  
AND CONTROLS

SAFETY  
DEVICES

CORRECT USE  
OF THE CAR

WARNING  
LIGHTS AND  
MESSAGES

IN AN  
EMERGENCY

CAR  
MAINTENANCE

TECHNICAL  
SPECIFICATIONS

INDEX

## REAL LEATHER TRIMMED STEERING WHEEL/ GEAR LEVER/HAND BRAKE

These components shall only be cleaned with water and neutral soap. Never use spirit or alcohol-based products.

Before using special products for cleaning interiors, read carefully label instructions and indications to make sure they are free from spirit and/or alcohol-based substances.

If drops of the special products used to clean the windscreen should fall on the leather steering wheel/gear lever/hand-brake, remove it immediately and then wash effected area with neutral soap and water.

**IMPORTANT** Take the utmost care when engaging the steering lock to prevent scratching the leather covering.



### WARNING

***Do not keep aerosol cans in the car: they might explode. Aerosol cans must never be exposed to a temperature above 50°C. The temperature inside the car exposed to the sun may go well beyond that figure.***

# TECHNICAL SPECIFICATIONS

IDENTIFICATION DATA .....	214
ENGINE CODES - BODYWORK VERSIONS .....	216
ENGINE .....	217
FUEL FEED/IGNITION .....	218
TRANSMISSION .....	218
BRAKES .....	219
SUSPENSIONS.....	219
STEERING.....	219
WHEELS.....	220
DIMENSIONS .....	224
PERFORMANCE.....	225
WEIGHTS.....	226
CAPACITIES .....	227
FLUIDS AND LUBRICANTS.....	228
FUEL CONSUMPTION .....	230
CO <sub>2</sub> EMISSIONS .....	231
RADIO FREQUENCY REMOTE CONTROL: MINISTERIAL HOMOLOGATION .....	232

DASHBOARD  
AND CONTROLS

SAFETY  
DEVICES

CORRECT USE  
OF THE CAR

WARNING  
LIGHTS AND  
MESSAGES

IN AN  
EMERGENCY

CAR  
MAINTENANCE

TECHNICAL  
SPECIFICATIONS

INDEX

## IDENTIFICATION DATA

You are advised to note the identification codes. The identification data stamped and given on the plates and their position are the following **fig. 1**:

- Model plate
- Chassis marking
- Bodywork paint identification plate
- Engine marking.

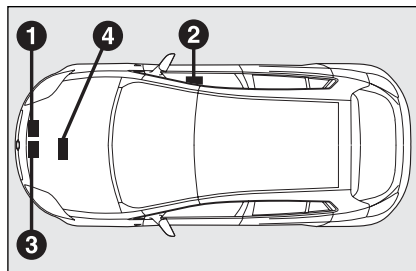

fig. 1

FOQ0736m

### MODEL PLATE **fig. 2**

The plate is to be found on the front cross-member of the engine compartment and bears the following identification data:

- B** Homologation number.
- C** Vehicle type code.
- D** Chassis number.
- E** Maximum vehicle weight fully loaded.
- F** Maximum vehicle weight fully loaded with trailer.

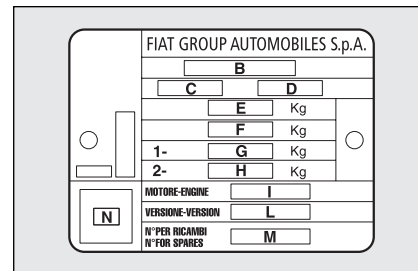

fig. 2

FOQ0029m

- G** Maximum vehicle weight on front axle.
- H** Maximum vehicle weight on rear axle.
- I** Engine type.
- L** Body version code.
- M** Spare part code.
- N** Smoke opacity index (for diesel engines).

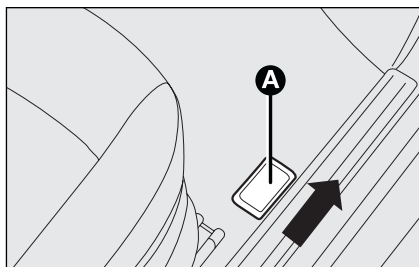

fig. 3

F0Q0667m

### CHASSIS MARKING

It is printed on the passenger compartment floor, near the right-hand front seat.

It can be reached by sliding forth the lid **A**-fig. 3.

It bears the following data:

- car model (ZFA I98000);
- chassis number.

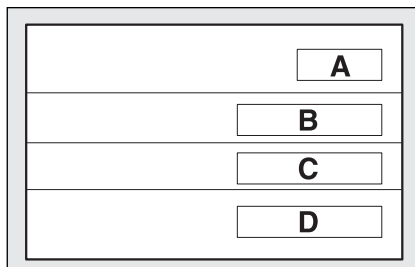

fig. 4

F0Q0100m

### BODYWORK PAINT IDENTIFICATION PLATE fig. 4

The plate is applied inside the bonnet and it bears the following data:

- A** - Paint manufacturer.
- B** - Colour name.
- C** - Fiat colour code.
- D** - Respray and touch up code.

### ENGINE MARKING

Engine marking is stamped on the cylinder block and includes the model and the chassis number.

DASHBOARD AND CONTROLS
SAFETY DEVICES
CORRECT USE OF THE CAR
WARNING LIGHTS AND MESSAGES
IN AN EMERGENCY
CAR MAINTENANCE
<b>TECHNICAL SPECIFICATIONS</b>
INDEX



## ENGINE CODES - BODYWORK VERSIONS

	Engine code	Bodywork version
<b>1.4 16V</b>	192B2000	198AXA1B 00
<b>1.4 T-JET 150 HP</b>	198A1000	198AXF1B 05 198AXF1B 05B (▲)
<b>1.9 Multijet 8V</b>	192A8000	198AXB1A 01 (■) 198AXB1A 01C (●) 198AXB1A 01B (■) (▲) 198AXB1A 01D (●) (▲)
<b>1.9 Multijet 16V</b>	937A5000	198AXC1B 02 (■) 198AXC1B 02C (●) 198AXC1B 02B (■) (▲) 198AXC1B 02D (●) (▲)
<b>1.9 Multijet 8V (□)</b>	192B4000	198AXD1A 03 (■) 198AXD1A 03C (●) 198AXD1A 03B (■) (▲) 198AXD1A 03D (●) (▲)
<b>1.9 Multijet 8V (□)</b>	192B5000	198AXE1A 04 198AXE1A 04C (■) 198AXE1A 04B (●) (▲)

(●) Versions with DPF

(■) Versions without DPF

(▲) Versions with option of 18" tyres

(□) Versions for specific markets

# ENGINE

GENERAL		1.4 16V	1.4 T-JET 150 HP	1.9 Multijet 8V	1.9 Multijet 16V	1.9 Multijet 8V (●)	1.9 Multijet 8V (●)
Engine code		192B2000	198A1000	192A8000	937A5000	192B5000	192B4000
Cycle		Otto	Otto	Diesel	Diesel	Diesel	Diesel
Number and layout of cylinders		4 in line	4 in line	4 in line	4 in line	4 in line	4 in line
Piston bore and stroke	mm	72.0 x 84.0	72.0 x 84.0	82.0 x 90.4	82.0 x 90.4	82.0 x 90.4	82.0 x 90.4
Total displacement	cm <sup>3</sup>	1368	1368	1910	1910	1910	1910
Compression ratio		11	9.8	18	17.5	18	18
Maximum power (EEC)	kW	66	110	88	110	66	85
	HP	90	150	120	150	90	115
corresponding ratio	rpm	5500	5500	4000	4000	4000	4000
Maximum torque (EEC)	Nm	128	206	255	305	255	255
	kgm	13	21	26	31	26	26
corresponding ratio	rpm	4500	2250	2000	2000	2000	2000
Spark plugs		NGK DCPR7E-N-10	NGK IKR9F8	–	–	–	–
Fuel		Unleaded petrol 95 RON (Specification EN228)	Unleaded petrol 95 RON (Specification EN228)	Diesel fuel for motor vehicles (Specification EN590)	Diesel fuel for motor vehicles (Specification EN590)	Diesel fuel for motor vehicles (Specification EN590)	Diesel fuel for motor vehicles (Specification EN590)

(●) Versions for specific markets

DASHBOARD  
AND CONTROLS

SAFETY  
DEVICES

CORRECT USE  
OF THE CAR

WARNING  
LIGHTS AND  
MESSAGES

IN AN  
EMERGENCY

CAR  
MAINTENANCE

TECHNICAL  
SPECIFICATIONS

INDEX

## FUEL FEED/IGNITION

	1.4 16V	1.4 T-JET 150 HP	1.9 Multijet 8V 1.9 Multijet 16V
Fuel feed	Multipoint sequential phased electronic injection returnless system	Multipoint sequential phased electronic injection with turbosupercharger and intercooler	Direct injection with electronically controlled Multijet "Common Rail" turbosupercharger and intercooler

## TRANSMISSION

	1.4 16V - 1.4 T-JET 150 HP - 1.9 Multijet 16V	1.9 Multijet 8V
Gearbox	Six forward gears and reverse with synchromesh for forward gear engagement	Five forward gears and reverse with synchromesh for forward gear engagement
Clutch	Self-adjusting pedal without idle stroke	Self-adjusting pedal without idle stroke
Drive	Front	Front



**Modifications or repairs to the fuel system that are not carried out properly or do not take the system's technical specifications into account can cause malfunctions leading to the risk of fire.**

## BRAKES

**1.4 16V - 1.4 T-JET 150 HP - 1.9 Multijet 8V - 1.9 Multijet 16V**

Service brakes:

– front

Disc, self-ventilating

– rear

Disc

Parking brake

Controlled by hand lever, it works on the rear brakes

**IMPORTANT** Water, ice and antifreeze salt on roads may deposit on the brake discs thus reducing braking efficiency at first braking.

## SUSPENSIONS

**1.4 16V - 1.4 T-JET 150 HP - 1.9 Multijet 8V - 1.9 Multijet 16V**

Front

McPherson independent wheels

Rear

Interconnected wheels with twisting axle

## STEERING

**1.4 16V - 1.4 T-JET 150 HP - 1.9 Multijet 8V - 1.9 Multijet 16V**

Type

Rack and pinion with electric power steering

Minimum steering cycle

m

10.4 (11.0 with 18" alloy wheel option)

DASHBOARD  
AND CONTROLS

SAFETY  
DEVICES

CORRECT USE  
OF THE CAR

WARNING  
LIGHTS AND  
MESSAGES

IN AN  
EMERGENCY

CAR  
MAINTENANCE

TECHNICAL  
SPECIFICATIONS

INDEX

# WHEELS

## RIMS AND TYRES

Pressed steel or alloy rims. Tubeless tyres with radial carcass. The homologated tyres are listed in the Log book.

**IMPORTANT** In the event of discrepancies between the information provided on this “Owner handbook” and the “Log book”, consider the specifications shown in the log book only.

Attaining to the prescribed size, to ensure safety of the car in movement, it must be fitted with tyres of the same make and type on all wheels.

**IMPORTANT** Do not use inner tubes with Tubeless tyres.

## SPARE WHEEL

Pressed steel rim. Tubeless tyre.

## WHEEL GEOMETRY

Front wheel toe-in measured from rim to rim:  $-1 \pm 1$  mm.

The values refer to the car in running order.

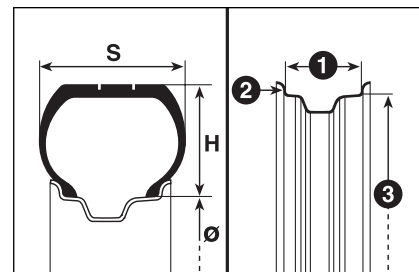

fig. 5

F0Q0200m

## UNDERSTANDING TYRE MARKING fig. 5

### Example: 195/65 R 15 91 T

**195** = Nominal width (S, distance between sidewalls in mm).

**65** = Percentage height/width ratio (H/S).

**R** = Radial tyre.

**15** = Rim diameter in inches ( $\varnothing$ ).

**91** = Load rating.

**T** = Maximum speed rating.

## Load rating

<b>60</b> = 250 kg	<b>84</b> = 500 kg
<b>61</b> = 257 kg	<b>85</b> = 515 kg
<b>62</b> = 265 kg	<b>86</b> = 530 kg
<b>63</b> = 272 kg	<b>87</b> = 545 kg
<b>64</b> = 280 kg	<b>88</b> = 560 kg
<b>65</b> = 290 kg	<b>89</b> = 580 kg
<b>66</b> = 300 kg	<b>90</b> = 600 kg
<b>67</b> = 307 kg	<b>91</b> = 615 kg
<b>68</b> = 315 kg	<b>92</b> = 630 kg
<b>69</b> = 325 kg	<b>93</b> = 650 kg
<b>70</b> = 335 kg	<b>94</b> = 670 kg
<b>71</b> = 345 kg	<b>95</b> = 690 kg
<b>72</b> = 355 kg	<b>96</b> = 710 kg
<b>73</b> = 365 kg	<b>97</b> = 730 kg
<b>74</b> = 375 kg	<b>98</b> = 750 kg
<b>75</b> = 387 kg	<b>99</b> = 775 kg
<b>76</b> = 400 kg	<b>100</b> = 800 kg
<b>77</b> = 412 kg	<b>101</b> = 825 kg
<b>78</b> = 425 kg	<b>102</b> = 850 kg
<b>79</b> = 437 kg	<b>103</b> = 875 kg
<b>80</b> = 450 kg	<b>104</b> = 900 kg
<b>81</b> = 462 kg	<b>105</b> = 925 kg
<b>82</b> = 475 kg	<b>106</b> = 950 kg
<b>83</b> = 487 kg	

## Maximum speed rating

<b>Q</b> = up to 160 km/h.
<b>R</b> = up to 170 km/h.
<b>S</b> = up to 180 km/h.
<b>T</b> = up to 190 km/h.
<b>U</b> = up to 200 km/h.
<b>H</b> = up to 210 km/h.
<b>V</b> = up to 240 km/h.
<b>W</b> = up to 270 km/h.
<b>Y</b> = up to 300 km/h.

## Maximum speed rating for snow tyres

<b>QM + S</b> = up to 160 km/h.
<b>TM + S</b> = up to 190 km/h.
<b>HM + S</b> = up to 210 km/h.

## UNDERSTANDING RIM MARKING fig. 5

### Example: 6J x 15 H2 ET 31.5

- 6** = rim width in inches (1).
- J** = rim drop center outline (side projection where the tyre bead rests) (2).
- 15** = rim nominal diameter in inches (corresponds to diameter of the tyre to be mounted) (3 = Ø).
- H2** = “hump” shape and number (relief on the circumference holding the Tubeless tyre bead on the rim).
- ET 31.5** = wheel camber angle (distance between the disc/rim supporting plane and the wheel rim centre line).

VERSIONS	RIMS	TYRES		SPACE-SAVER SPARE WHEEL (where provided)	
		Standard tyres	Snow tyres	Rim	Tyre
<b>1.4 16v</b>	6j x 15 ET 31.5	195/65 R15 91H	195/65 R15 91T (M+S)	(O)	(O)
	7j x 16 ET 31	205/55 R16 91H	205/55 R16 91T (M+S)		
	7j x 17 ET 31	225/45 R17 91V (*)	225/45 R17 91T (M+S)	7j x 16 ET 31	205/55 R16 91H (**)
<b>1.9 Multijet 8v</b>	6j x 15 ET 31.5	195/65 R15 91H	195/65 R15 91T (M+S)	(O)	(O)
	7j x 16 ET 31	205/55 R16 91H	205/55 R16 91T (M+S)		
	7j x 17 ET 31	225/45 R17 91V (*)	225/45 R17 91T (M+S)		
	7 <sup>1/2</sup> j x 18 ET 35	225/40 R18 92V (*)	225/40 R18 92T (M+S)	7j x 16 ET 31	205/55 R16 91H (**)
<b>1.4 T-JET 150 HP</b> <b>1.9 Multijet 16v</b>	6j x 15 ET 31.5	195/65 R15 91V	195/65 R15 91T (M+S)	(O)	(O)
	7j x 16 ET 31	205/55 R16 91V	205/55 R16 91T (M+S)		
	7j x 17 ET 31	225/45 R17 91V (*)	225/45 R17 91T (M+S)		
	7 <sup>1/2</sup> j x 18 ET 35	225/40 R18 92V (*)	225/40 R18 92T (M+S)	7j x 16 ET 31	205/55 R16 91H (**)

(O) On versions equipped with 195/65 R15 and 205/55 R16 tyres, a normal sized tyre may be ordered as an alternative to the small spare wheel.

(\*) Tyres cannot be fitted with chains.

(\*\*) The 205/55 R16 91H tyre has the same characteristics of the spare tyre: the texts and the warnings contained in the paragraph "If a tyre is punctured" are referred to the 205/55 R16 91H tyre.

**IMPORTANT** The use of 225/40 R18 92V tyres requires specific technical measures to be adopted. For this reason, this tyre may only be ordered at the time of vehicle purchase. Do not install this tyre after vehicle purchase!

## COLD TYRE INFLATION PRESSURE (bar)

	Size	STANDARD TYRES			
		Medium load		Full load	
		Front	Rear	Front	Rear
1.4 16V	195/65 R15 91H	2.3	2.3	2.6	2.6
	205/55 R16 91H	2.3	2.3	2.6	2.6
	225/45 R17 91V	2.3	2.3	2.6	2.6
1.9 Multijet 8V	195/65 R15 91H	2.3	2.3	2.6	2.6
	205/55 R16 91H	2.3	2.3	2.6	2.6
	225/45 R17 91V	2.3	2.3	2.6	2.6
	225/40 R18 92V	2.6	2.6	2.9	2.9
1.9 Multijet 16V 1.4 T-JET 150 HP	195/65 R15 91V	2.3	2.3	2.6	2.6
	205/55 R16 91V	2.3	2.3	2.6	2.6
	225/45 R17 91V	2.3	2.3	2.6	2.6
	225/40 R18 92V	2.6	2.6	2.9	2.9

Add +0.3 bar to the prescribed inflation pressure when the tyres are warm. Recheck pressure value with cold tyres.

With snow tyres, add +0.2 bar to the inflation pressure value prescribed for standard tyres.

**When running at speed higher than 160 km/h, inflate tyres at full load inflation values.**

T.P.M.S. system not available for tyre 195/65 R15 91H



## DIMENSIONS

Dimensions are expressed in mm and refer to the car fitted with standard tyres.

The height refers to the car unladen.

### Boot volume

Unladen boot volume (V.D.A. standards) ..... 400 dm<sup>3</sup> with Cargo Box (where fitted) located in the luggage compartment.

Extended boot volume with rear seat back folded ..... 1175 dm<sup>3</sup> with Cargo Box (where fitted) located in the luggage compartment.

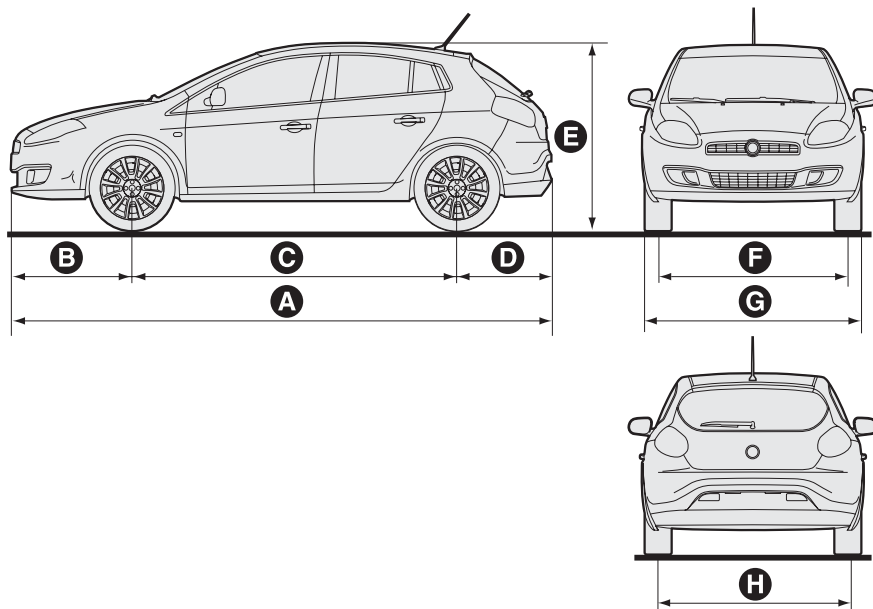

fig. 6

F0Q0003m

A	B	C	D	E	F	G	H
4336	974	2600	762	1498	1538 1530 (●)	1792	1532 1524 (●)

Track measurements may vary according to rim size.

(●) With 18" alloy wheel option.

# PERFORMANCE

Top admitted speed after initial car use in km/h.

1.4 16v	1.4 T-JET 150 HP	1.9 Multijet 8v 120 HP	1.9 Multijet 8v 90 HP (*)	1.9 Multijet 8v 115 HP (*)	1.9 Multijet 16v
179	212	194	174	190	209

(\*) Versions for specific markets

DASHBOARD  
AND CONTROLS

SAFETY  
DEVICES

CORRECT USE  
OF THE CAR

WARNING  
LIGHTS AND  
MESSAGES

IN AN  
EMERGENCY

CAR  
MAINTENANCE

TECHNICAL  
SPECIFICATIONS

INDEX

## WEIGHTS

Weights (kg)	1.4 16V	1.4 T-JET 150 HP	1.9 Multijet 8V	1.9 Multijet 16V
Kerb weight (including all fluids, fuel tank at 90% and with no optional)	1205	1275	1320	1360
Payload (*) including the driver:	510	510	510	510
Maximum admitted loads (**)				
– front axle:	1000	1000	1060	1060
– rear axle:	860	860	860	860
– total:	1715	1785	1830	1870
Towable loads				
– trailer with brakes:	1000	1300	1300	1300
– trailer without brakes:	500	500	500	500
Maximum load on roof (***):	80	80	80	80
Maximum load on tow hitch (trailer with brakes):	60	60	60	60

(\*) If special equipment is fitted (sunroof, tow hitch, etc.) the unladen car weight increases, thus reducing the specified payload.

(\*\*) Loads not to be exceeded. The driver is responsible for arranging the loads in the boot an/or on the roof so that they comply with these limits.

(\*\*\*) Lineaccessori Fiat roof rack, max capacity: 50 kg.

# CAPACITIES

	1.4 16V - 1.4 T-JET 150 HP		1.9 Multijet		Recommended fuels and genuine lubricants
	litres	kg	litres	kg	
Fuel tank: including a reserve of:	57 8-10	– –	57 (●) 8-10 (●)	– –	Unleaded petrol with no less than 95 R.O.N (Specification EN228) (●) Diesel fuel for motor vehicles (Specification EN590)
Engine cooling system – with climate control:	–	5.2	–	7.0	Mixture of 50% demineralised water and 50% <b>PARAFLU<sup>UP</sup></b> (▲)
Engine sump: Engine sump and filter:	2.75 2.9	2.4 2.55	4.4 (■) 4.7 (■)	3.8 (■) 4.0 (■)	<b>SELENIA K P.E.</b> (■) <b>SELENIA WR</b>
Gearbox/differential casing:	1.87 2.4 (○)	1.7 2.0 (○)	1.76 (□) 1.87 (△)	1.6 (□) 1.7 (△)	<b>TUTELA CAR TECHNYX</b> <b>TUTELA CAR MATRIX</b> (○)
Hydraulic brake circuit with ABS:	–	0.525	–	0.525	<b>TUTELA TOP 4</b>
Windscreen / rear window / headlight washer fluid reservoir: (*)	3 (6)	–	3 (6)	–	Mixture of water and <b>TUTELA</b> <b>PROFESSIONAL SC 35</b>

(\*) The values in brackets refer to versions with headlight washers.

(□) Version 1.9 Multijet 8v

(△) Version 1.9 Multijet 16v

(○) Version 1.4 T-JET 150 HP

(▲) For particularly hard climate conditions, we recommend use of a 60% **PARAFLU<sup>UP</sup>** and 40% demineralized water mixture.

DASHBOARD  
AND CONTROLS

SAFETY  
DEVICES

CORRECT USE  
OF THE CAR

WARNING  
LIGHTS AND  
MESSAGES

IN AN  
EMERGENCY

CAR  
MAINTENANCE

TECHNICAL  
SPECIFICATIONS

INDEX

# FLUIDS AND LUBRICANTS

## RECOMMENDED PRODUCTS AND THEIR SPECIFICATIONS

Use	Fluid and lubricant specifications for correct car operation	Genuine fluids and lubricants	Change intervals
Oils for petrol engines	Synthetic-based oils, grade SAE 5W-40 <b>FIAT 9.55535-S2</b> qualification or ACEA C3 specification.	<b>SELENIA K P.E.</b>	As per Service Schedule
Oils for diesel engines	Synthetic-based oils, grade SAE 5W-40 <b>FIAT 9.55535-N2</b> qualification.	<b>SELENIA WR</b>	As per Service Schedule

For the correct function of the diesel versions with DPF use exclusively the original lubricant type. In emergency cases, where the original product is not available, execute a fill up of only 0,5 lt. maximum and as soon as possible go to the Fiat Dealership.

In case of use of AE 5W-40 non original products, lubricants with minimum performances are accepted ACEA B4 for diesel engines; in this case optimal performances of the engine are not guaranteed.

The use of products with inferior characteristics compared to ACEA C3 and ACEA B4 could cause damage, not covered by the guarantee, to the engine.

For particularly rigid climatic conditions ask the Fiat Dealership for the appropriate product from the **Selenia** range.

Use	Fluid and lubricant specifications for correct car operation	Genuine fluids and lubricants	Applications
Lubricants and greases for transmissions	Synthetic-based oil, grade SAE 75W-85 that passes API GL-4 PLUS, FIAT 9.55550 specifications.	<b>TUTELA CAR TECHNIX</b>	Mechanical gearbox and differential
	Synthetic-based oil, grade SAE 75W-85 that passes API GL-4 specifications	<b>TUTELA CAR MATRYX</b>	Mechanical gearbox and differential
	Specific grease to be used for constant-velocity joints with low friction coefficient. N.L.G.I. 0-1 consistency.	<b>TUTELA STAR 700</b>	CV joints on differential side
	Grease containing Molybdenum bisulphide for high temperature appliances. N.L.G.I. 1-2 consistency.	<b>TUTELA ALL STAR</b>	CV joints on wheel side
Brake fluid	Synthetic fluid, FMVSS n° 116 DOT 4, ISO 4925 SAE J1704, CUNA NC 956-01	<b>TUTELA TOP 4</b>	Brake and clutch hydraulic controls
Protective agent for radiators	Protective with antifreeze action, red colour based on inhibited monoethylen glycol and organic formula, that passes CUNA NC 956-16, ASTM D 3306 specifications.	<b>PARAFLU<sup>UP</sup> (●)</b>	Radiator antifreeze proportion: 50% distilled water and 50% PARAFLU <sup>UP</sup> (□)
Additive for diesel fuel	Additive for diesel fuels with protective action for Diesel engines	<b>TUTELA DIESEL ART</b>	To be used diluted or undiluted
Windscreen/rear window/headlight washer fluid	Mixture of alcohol and surfactants CUNA NC 956-11	<b>TUTELA PROFESSIONAL SC 35</b>	To be mixed with diesel fuel (25 cc per 10 litres)

(●) IMPORTANT Do not add or mix fluids having different specifications from that already existing.

(□) For particularly hard climate conditions, we recommend use of a 60% **PARAFLU<sup>UP</sup>** and 40% demineralized water mixture.

## FUEL CONSUMPTION

The fuel consumption figures given in the table below are determined on the basis of the homologation tests set down by specific European Directives.

The procedures below are followed for measuring consumption:

- urban cycle:** cold starting followed by driving that simulates urban use of the car;

- extra-urban cycle:** frequent accelerating in all gears, simulating extraurban use of the car; the speed varies between 0 and 120 km/h;
- combined consumption:** is calculated weighing about 37% of urban cycle consumption and about 63% of extraurban consumption.

**IMPORTANT** The type of route, traffic situations, weather conditions, driving style, general conditions of the car, trim level/equipment/accessories, load, climate control system, roof rack, other situations that affect air drag may lead to different fuel consumption levels than those measured.

### Fuel consumption according to Directive 1999/100/EC (litres x 100 km)

	1.4 16V	1.4 T-JET 150 HP	1.9 Multijet 8V	1.9 Multijet 8V 90 HP (●) 1.9 Multijet 8V 115 HP (●)	1.9 Multijet 16V
<b>Urban</b>	8.7	9.3	6.9	6.8	7.6
<b>Extra-urban</b>	5.6	5.8	4.3	4.2	4.5
<b>Combined</b>	6.7	7.1	5.3	5.2	5.6

(●) Versions for specific markets

# CO<sub>2</sub> EMISSIONS

The CO<sub>2</sub> emission levels at the exhaust given in the following table refer to combined consumption.

## CO<sub>2</sub> emissions according to 1999/100/EC Directive (g/km)

1.4 16V	1.4 T-JET 150 HP	1.9 Multijet 8v	1.9 Multijet 8v 90 HP (●) 1.9 Multijet 8v 115 HP (●)	1.9 Multijet 16V
158	167	139	137	149

(●) Versions for specific markets

DASHBOARD  
AND CONTROLS

SAFETY  
DEVICES

CORRECT USE  
OF THE CAR

WARNING  
LIGHTS AND  
MESSAGES

IN AN  
EMERGENCY

CAR  
MAINTENANCE

TECHNICAL  
SPECIFICATIONS

INDEX



# RADIO FREQUENCY REMOTE CONTROL: Ministerial homologation



Notified Body Directive 99/5/EC  
Competent Body EMC Directive 89/336/EEC  
Notified Body EMC Directive 89/336/EEC  
FCB under the Canada-EC MRA  
TCB under the USA-EC MRA

EC Identification No. **0678**



Designated by the German Regulator

to act as a Notified Body in accordance with the R&TTE Directive 1999/5/EC of 9. March 1999

## EC-R&TTE CERTIFICATE

Registration No.

G102952U

Certificate Holder

MAGNETI MARELLI SISTEMI ELETTRONICI SpA  
Via Aldo Boriotti, 61/63  
20011 Corbetta (MI)  
Italy

Product Designation

TRF 192.02, TRF 841.02, TRF S20.02

Product Description

Low Power Device

Manufacturer

MAGNETI MARELLI SISTEMI ELETTRONICI SpA  
Via Aldo Boriotti, 61/63  
20011 Corbetta (MI)  
Italy

Essential Requirement	Applied Specifications / Standards	Documentary Evidence	Result
Art. 3.1(a)   Health	Not assessed		
Art. 3.1(b)   Safety	EN 60950	Declaration of Conformity	conform
Art. 3.1(b)   EMC	EN 301 488-1/-3	Test Report E20471 Edition 2	conform
Art. 3.2   Radio	EN 300 220-1/-3	Test Report R20471 Edition 2	conform

The product shall be marked with the CE conformity marking and our Notified Body number as shown on the right.

**CE 0678**

The scope of evaluation relates to the submitted documents only.

This Certificate is issued in accordance with Annex IV of the R&TTE Directive 1999/5/EC of 9<sup>th</sup> March, 1999 and is only valid in conjunction with the attached Annex.

Ebermannstadt,  
2006-05-23

  
Edith de Fuchs  
Notified Body



to act as a Notified Body in accordance with the R&TTE Directive 1999/5/EC of 9. March 1999

## EC-R&TTE CERTIFICATE

Registration No.

G103345U

Certificate Holder

Magneti Marelli Sistemi Elettronici S.p.A.  
Viale A. Borletti, 61/63  
20011 Corbetta (MI)  
Italy

Product Designation

Electronic immobilizer, Model NBC 198L4

Product Description

Electronic immobilizer with inductive transponder at 125 kHz

Manufacturer

Magneti Marelli Sistemi Elettronici S.p.A.  
Viale A. Borletti, 61/63  
20011 Corbetta (MI)  
Italy

Essential Requirement	Applied Specifications / Standards	Documentary Evidence	Result
Art. 3.1(a) Health	Not assessed		
Art. 3.1(b) Safety	74/61/EEC, 95/56/EC	Test Report 55.00106.06	conform
Art. 3.1(b) EMC	72/459/EEC, 2006/28/EC	Test Report 55.00106.06	conform
Art. 3.2 Radio	EN 300 330-1/-2	Test Report R06115901	conform

The product shall be marked with the CE conformity marking and our Notified Body number as shown on the right.

**CE 0678**

The scope of evaluation relates to the submitted documents only.

This Certificate is issued in accordance with Annex IV of the R&TTE Directive 1999/5/EC of 9<sup>th</sup> March, 1999 and is only valid in conjunction with the attached Annex.

Ebermannstadt,  
2006-11-24

  
Klaus Kriehog  
Notified Body



# DASHBOARD

The presence and the position of the instruments and warning lights may vary according to the versions.

RIGHT HAND DRIVE VERSIONS

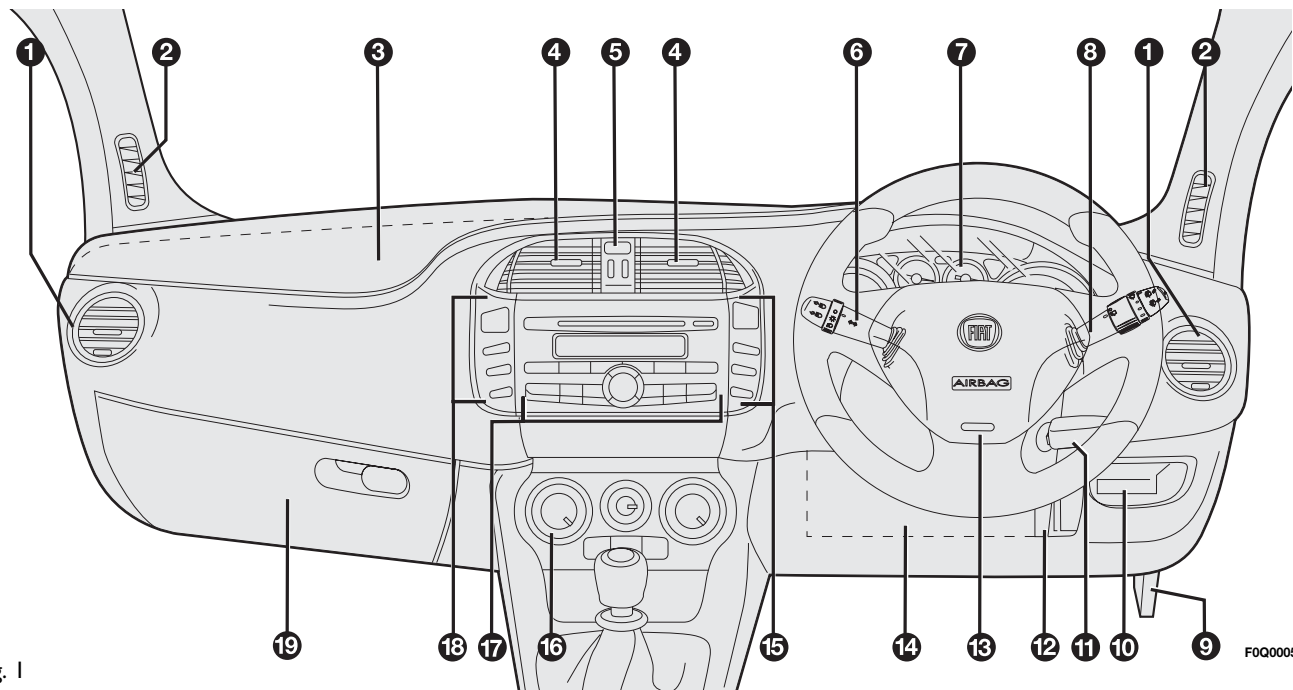

F0Q005m

fig. 1

- 1. Adjustable and swivel air vent - 2. Side window air vent - 3. Front passenger air bag - 4. Adjustable and swivel air vents - 5. Hazard light switch - 6. External light stalk - 7. Instrument panel - 8. Windscreen/rear window wiper/trip computer stalk - 9. Bonnet opening lever - 10. Fusebox access door - 11. Ignition key and ignition device - 12. Steering wheel locking/release stalk - 13. Driver's air bag - 14. Driver's knees air bag (where provided) - 15. Set of switches for front/rear fog lights and menu opening/setting - 16. Controls for heating/ventilation/climate control - 17. Sound system controls - 18. Set of ON/OFF switches for electric power steering and ASR system (where provided) - 19. Glovebox

# INSTRUMENT PANEL

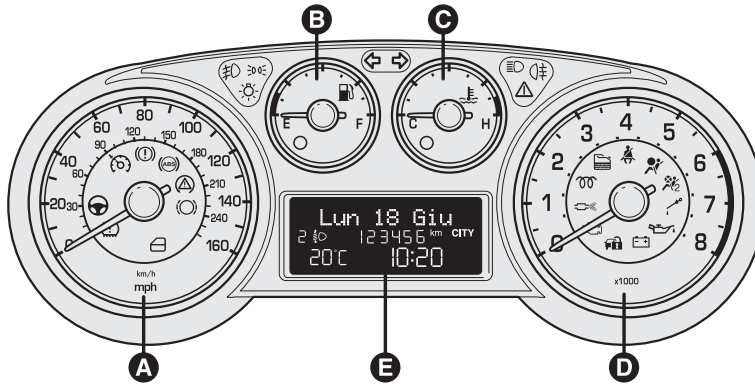

fig. 2

FOQ0006m

## Versions with multifunction display

- A** Speedometer (speed indicator)
- B** Fuel level gauge with reserve warning light
- C** Engine coolant temperature gauge and excessive temperature warning light
- D** Rev counter
- E** Multifunction display.

⚠ Warning lights fitted on diesel versions only

On diesel versions the rev counter end scale value is 6000 rpm.

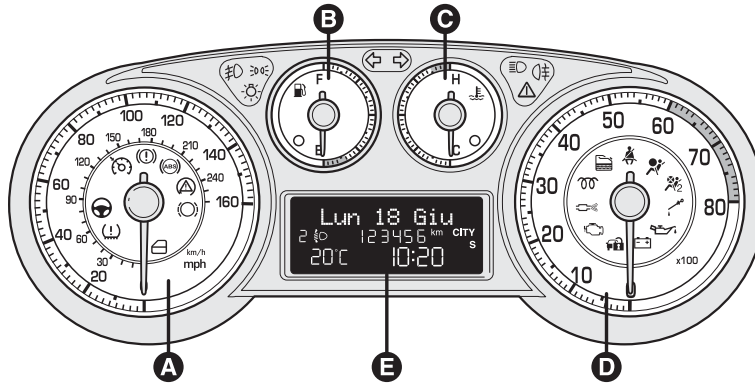

fig. 3

FOQ0007m

## Sport versions with multifunction display

- A** Speedometer (speed indicator)
- B** Fuel level gauge with reserve warning light
- C** Engine coolant temperature gauge and excessive temperature warning light
- D** Rev counter
- E** Multifunction display.

⚠ Warning lights fitted on diesel versions only

On diesel versions the rev counter end scale value is 6000 rpm.

## Versions with reconfigurable multifunction display

- A** Speedometer (speed indicator)
  - B** Fuel level gauge with reserve warning light
  - C** Engine coolant temperature gauge and excessive temperature warning light
  - D** Rev counter
  - E** Reconfigurable multifunction display.
- ☹ ☹ Warning lights fitted on diesel versions only

On diesel versions the rev counter end scale value is 6000 rpm.

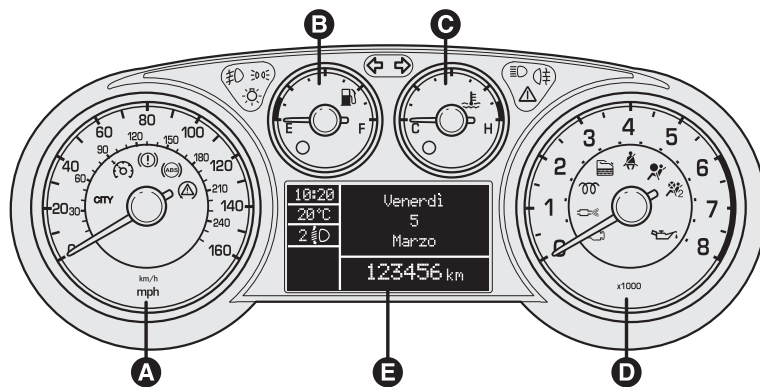

F0Q008m

fig. 4

## Sport versions with reconfigurable multifunction display

- A** Speedometer (speed indicator)
  - B** Fuel level gauge with reserve warning light
  - C** Engine coolant temperature gauge and excessive temperature warning light
  - D** Rev counter
  - E** Reconfigurable multifunction display.
- ☹ ☹ Warning lights fitted on diesel versions only

On diesel versions the rev counter end scale value is 6000 rpm.

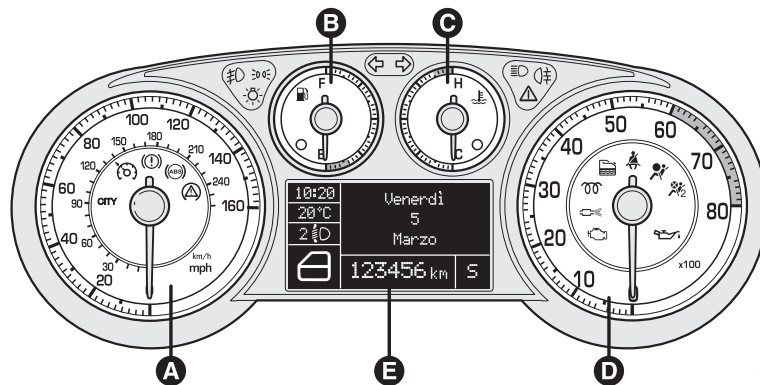

F0Q009m

fig. 5

# INDEX

<b>ABS</b> .....	86	<b>Car maintenance</b> .....	191	Diesel particulate filter (DPF) .....	104
Air bag		– scheduled servicing .....	192	Dimensions .....	224
– front .....	120	– service schedule .....	193	Dipped beam headlights .....	55
– side .....	123	– heavy duty .....	195	Direction indicators	
Air cleaner/Pollen filter .....	201	– routine maintenance .....	195	– activation .....	55
Alarm .....	16	Carrying children safely .....	112	– bulbs replacement .....	171-172
Ashtray .....	69	Ceiling lights .....	63	Doors	
ASR system .....	89	Central door locking system .....	75	– child lock .....	75
At the filling station .....	102	Checking fluid levels .....	196	– rear doors emergency	
Automatic two-zone climate		Child locks .....	75	lock device .....	76
control system .....	49	Cigar lighter .....	69	DPF (diesel particulate filter) .....	104
<b>B</b> attery .....	79	CO <sub>2</sub> emissions .....	231	Dualdrive	
– jump starting .....	156	Code Card .....	10	(electric power steering) .....	94
– recharge .....	188	Containing running costs .....	135	<b>Engine codes/Bodywork versions</b> ..	216
– replacement .....	202	Controls .....	65	Engine compartment (washing) .....	210
Bodywork .....	208	<b>Correct use of the car</b> .....	129	Engine starting .....	130-156
– bodywork versions .....	216	Courtesy mirror light		EOBD system .....	91
Bonnet .....	83	(bulb replacement) .....	177	ESP system .....	88
Boot .....	79	Cruise Control .....	61	Exterior lights (replacement) .....	170
Brake Assist .....	87	Current outlet .....	69	External lights .....	55
Brakes .....	219	<b>D</b> ashboard .....	5	<b>Fiat CODE system</b> .....	8
<b>C</b> apacities .....	227	<b>Dashboard and controls</b> .....	4	Fix&Go automatic .....	163
Car inactivity .....	140	Daylight sensor .....	56	Fluids and lubricants .....	228

Follow me home device .....	56	If an exterior light burns out .....	170	<b>P</b> aint .....	209
Front/rear armrest .....	67-68	If the battery is flat .....	188	Parking .....	133
Fuel consumption .....	230	Ignition switch .....	19	Parking lights .....	55
Fuel cut-off switch .....	66	<b>In an emergency</b> .....	155	Parking sensors .....	99
Fuel feed/Ignition .....	218	Installation of electric/electronic devices .....	93	Performance .....	225
Fuel filler cap .....	103	Instrument panel .....	6	Power windows .....	77
Fuse replacement .....	178	Instruments .....	20	Pretensioners .....	109
<b>G</b> lass holder/ oddment compartment.....	70	Interior fittings .....	67	Protecting the environment .....	103
Glove box light (bulb replacement) .....	177	Interior lights .....	175	<b>Q</b> uick tyre repair Kit Fix & Go automatic .....	163
<b>H</b> andbrake .....	133	Interiors .....	210	<b>R</b> adio transmitters and cellular telephones .....	93
Hazard lights .....	65	<b>J</b> acking the car .....	189	Rain sensor .....	58
Head restraints .....	39	Jump starting .....	156	Rear fog lights .....	65
Headlight washer .....	60	<b>K</b> eys .....	10	Rear view mirrors .....	41
Headlights .....	85	<b>L</b> oad limiters .....	109	Rear window washer – activation .....	60
Heating and ventilation .....	44	<b>M</b> ain beam headlights .....	55	– blades .....	206
Heating and ventilation .....	44	Manual climate control system .....	46	– nozzles .....	207
Heating/climate control system .....	42	MSR system .....	90	Rear window wiper – activation .....	57
Hill Holder system .....	88	Multifunction display .....	22	– blades .....	206
<b>I</b> dentification codes .....	216	<b>N</b> umber plate lights (bulb replacement) .....	174	– nozzles .....	207
Identification data .....	214	<b>O</b> ddment compartments .....	68	Reconfigurable Multifunction display .....	23
If a fuse blows .....	178				
If a tyre is punctured .....	157				

Remote control: ministerial homologations .....	232	Steering wheel .....	40	Wheel geometry .....	220
<b>Right hand drive versions</b> .....	234	Sun roof .....	72	Wheels and tyres .....	204-220
Rim marking .....	221	Sun visors .....	71	When needing to change a bulb .....	167
Roof rack/ski rack .....	84	Suspensions .....	219	Window washing .....	57
Rubber hoses .....	205	Symbols .....	8	Windows (cleaning) .....	210
<b>Safe lock device</b> .....	14	<b>T.P.M.S. system</b> .....	96		
S.B.R system .....	108	<b>Technical specifications</b> .....	213		
<b>Safety devices</b> .....	105	Third brake light (bulb replacement) .....	174		
Seat belts .....	106	Towing the car .....	189		
Seats .....	37	Towing trailers .....	137		
– cleaning .....	210	Transmission .....	218		
– manual adjustment .....	37	Trip Computer .....	35		
– electrical adjustment .....	38	Tyres			
– seat warming .....	38	– replacement .....	157		
Side lights		– snow tyres .....	139		
– activation .....	55	– standard tyres .....	222		
– bulbs replacement .....	171-172	– tyre marking .....	220		
Smart washing function .....	58	– pressure.....	223		
Snow chains .....	139	<b>Using the gearbox</b> .....	134		
Sound System .....	92	Isofix child restraint system .....	117		
Spark plugs .....	217	<b>Warning lights and messages</b> ...	141		
Sport function .....	95	Weights .....	226		
Spray nozzles .....	207				
Steering .....	219				
Steering column lock .....	19				



## **PROVISIONS FOR THE PROCESSING OF A VEHICLE AT THE END OF ITS LIFE-CYCLE**

For years now Fiat has been developing its global commitment towards the safeguarding and protection of the Environment through the continuous improvement of its production processes and the making of increasingly more “eco friendly” products. With a view to guaranteeing the best possible service to clients in full observance of environmental standards and in response to the obligations imposed by European Directive 2000/53/EC on end-of-life vehicles, Fiat offers its clients the possibility to hand in their vehicle\* at the end of its life span without additional costs.

The European Directive, in fact, provides for the take-back of the vehicle without the last holder or owner of the same incurring expenses due to the fact that the market value of the vehicle is zero or negative. In particular, in almost all of the countries of the European Union, up until 1st January 2007, take-back of the vehicle free of charge only applies to vehicles registered from 1 July 2002 on, while, from 2007 on, take-back will be carried out free of charge, independently of the year of registration, provided that the vehicle still contains all its essential component parts (especially engine and body) and is free from additional waste materials.

Our contracted network of authorised treatment facilities has been carefully selected in order to provide a quality service to our customers by de-polluting and recycling “End of Life Vehicles” to approved environmental standards. To find out the location of your nearest authorised treatment facility, offering free of charge take-back, simply contact one of our dealers or refer to the Fiat web site or call the toll free number 00800 3428 0000.

\* Passenger transportation vehicles to seat a max. of nine persons, having a total admissible weight of 3.5 t

# SELENIA®

***At the heart of your engine.***



Always ask your mechanic for **SELENIA®**

*Oil change? The experts recommend Selenia.*

*The engine of your car is factory filled with **Selenia**. This is an engine oil range which satisfies the most advanced international specifications. Its superior technical characteristics allow **Selenia** to guarantee the **highest performance** and **protection of your engine**.*

---

*The Selenia range includes a number of technologically advanced products:*

#### **SELENIA PERFORMER MULTIPOWER**

Particularly ideal for the protection of new generation petrol engines, very effective even in the most severe weather conditions. It guarantees a reduction in fuel consumption (Energy conserving ) and it is also ideal for alternative engines.

#### **SELENIA K**

is the synthetic lubricant with innovative technology, which ensures improved cold starting for petrol engines and the utmost protection also under typically “urban” conditions of use. Owing to its 5W-40 viscosimetric grade and its special formulation it more effectively meets the emission limits required by new European regulations and exceeds the major international specifications.

#### **SELENIA WR**

Oil specifically designed for common rail Multijet engines. Particularly effective during cold starts, it guarantees maximum wear protection and hydraulic tappets control, reduction in consumption and stability at high temperatures.

#### **SELENIA DIGITECH**

Fully synthetic lubricant for petrol and diesel engines. Its advanced technology guarantees maximum protection, a reduction in consumption and reliability in extreme climate conditions.

The range also includes Selenia StAR, Selenia Racing, Selenia 20K Alfa Romeo, Selenia TD, Selenia Performer 5W-40  
For further information on Selenia products visit the web site [www.fliselenia.com](http://www.fliselenia.com).

---



## COLD TYRE INFLATION PRESSURE (bar)

	Size	STANDARD TYRES			
		Medium load		Full load	
		Front	Rear	Front	Rear
I.4 16V	195/65 R15 91H	2.3	2.3	2.6	2.6
	205/55 R16 91H	2.3	2.3	2.6	2.6
	225/45 R17 91V	2.3	2.3	2.6	2.6
I.9 Multijet 8V	195/65 R15 91H	2.3	2.3	2.6	2.6
	205/55 R16 91H	2.3	2.3	2.6	2.6
	225/45 R17 91V	2.3	2.3	2.6	2.6
I.4 T-JET 150 HP I.9 Multijet 16V	225/40 R18 92V	2.6	2.6	2.9	2.9
	195/65 R15 91V	2.3	2.3	2.6	2.6
	205/55 R16 91V	2.3	2.3	2.6	2.6
I.9 Multijet 16V	225/45 R17 91V	2.3	2.3	2.6	2.6
	225/40 R18 92V	2.6	2.6	2.9	2.9

Add +0.3 bar to the prescribed inflation pressure when the tyres are warm. Recheck pressure value with cold tyres.

With snow tyres, add +0.2 bar to the inflation pressure value prescribed for standard tyres.

**When running at speed higher than 160 km/h, inflate tyres at full load inflation values.**

T.P.M.S. system not available for tyre 195/65 R15 91H.

## ENGINE OIL CHANGE

	I.4 16V - I.4 T-JET 150 HP		I.9 Multijet 8V - I.9 Multijet 16V	
	litres	kg	litres	kg
Fuel tank	2.75	2.4	4.4	3.8
Engine sump and filter	2.9	2.55	4.7	4.0

## FUEL CAPACITIES (litres)

	I.4 16V - I.4 T-JET 150 HP - I.9 Multijet 8V - I.9 Multijet 16V
Tank capacity	57
Reserve	8-10

Refuel petrol engines with unleaded petrol with octane rating (RON) no lower than 95 only (EN 228 Specifications)

Refuel diesel engines with diesel fuel for motor vehicles only (EN 590 Specifications)

The data contained in this publication is intended merely as a guide. FIAT reserves the right to modify the models and versions described in this booklet at any time for technical and commercial reasons.

If you have any further questions please consult your FIAT dealer.

Printed in recycled paper without chlorine.